



USER MANUAL

SILO SERIES



Index

| | |
|------------------------------------------------------------|----|
| 1. GENERAL INFORMATION AND SAFETY INSTRUCTIONS | |
| 1.1. About the User Manual | 7 |
| 1.2. Meanings of Symbols Used in User Manual..... | 7 |
| 1.3. Personal Protective Equipments..... | 8 |
| 1.4. Terms of Use and Safety Information | 9 |
| 1.5. Possible Dangers | 9 |
| 1.6. Danger Areas..... | 13 |
| 1.7. Weather Conditions | 14 |
| 2. MAIN INFORMATIONS | |
| 2.1. Vehicle Identification Plate | 15 |
| 2.2. Brake Data Plate..... | 15 |
| 2.3. VIN (Chassis) Numbers | 16 |
| 2.4. Warranty and Responsibility | 16 |
| 3. TRAILER RUNNING GEAR AND USAGE INSTRUCTIONS | |
| 3.1. Brake System | 17 |
| 3.1.1. Air Couplings | 17 |
| 3.1.2. Compressed Air Tanks | 19 |
| 3.1.3. EBS Socket..... | 20 |
| 3.1.4. Roll Stability Support (RSS)..... | 21 |
| 3.1.5. PREV (Park Release Emergency Valve) | 21 |
| 3.1.6. Brake Chambers | 23 |
| 3.2. Suspension System..... | 24 |
| 3.2.1. Manuel Control Lever | 24 |
| 3.2.2. Auto Reset..... | 25 |
| 3.2.3. Electronic Controlled Air Suspension (ECAS)..... | 25 |
| 3.3. Electrical System..... | 25 |
| 3.3.1. 15 Pin Socket..... | 26 |
| 3.3.2. 2x7 Pin Socket..... | 27 |
| 3.3.3. Light System | 28 |
| 3.4. King Pin | 29 |
| 3.5. Landing Gear..... | 29 |
| 3.5.1. Front Landing Gear's Working Principle..... | 29 |
| 3.5.2. Rear Landing Gear Working Principle..... | 31 |
| 3.6. Side Protection Equipment (Underrun Protection) | 31 |
| 3.7. Semi-Trailer Axle System..... | 32 |
| 3.7.1. Self-Steering Axles | 32 |

| | | |
|-----------|------------------------------------------------------------------------|----|
| 3.7.2. | Axle Lifting..... | 34 |
| 3.7.3. | Hubodometer..... | 34 |
| 3.8. | Tires..... | 35 |
| 3.9. | Spare Wheel Holder | 36 |
| 3.9.1. | Crane Type Spare Wheel Holder..... | 36 |
| 3.10. | Mudguards..... | 37 |
| 3.11. | Mudguard with Sheet | 37 |
| 3.12. | Wheel Chock..... | 37 |
| 3.12.1. | Pin Type Wheel Chock Holder | 37 |
| 3.12.2. | Pocket Type Wheel Chock Holder..... | 38 |
| 3.13. | Boxes and Storage Units | 38 |
| 3.13.1. | Stainless Steel Toolbox | 38 |
| 3.13.2. | Plastic Toolbox..... | 38 |
| 3.13.3. | Aluminium Toolbox..... | 39 |
| 3.13.4. | Fire Extinguisher Cabinet | 39 |
| 3.13.5. | Water Tank | 40 |
| 3.13.6. | Hose Carriers..... | 41 |
| 3.13.7. | Hydraulic Pump and Oil Tank..... | 41 |
| 3.14. | Working Lamp..... | 41 |
| 3.15. | Ladder and Walkway..... | 42 |
| 3.15.1. | Foldable Ladder | 42 |
| 3.15.2. | Fixed Front Ladder..... | 43 |
| 3.15.3. | Walkway..... | 43 |
| 3.15.4. | Rope | 43 |
| 3.16. | Rear Bumper (Rear Protection Equipment) | 44 |
| 3.16.1. | Fixed Bumper..... | 44 |
| 3.17. | Night Park Plate | 44 |
| 3.18. | Sliding Sheet Metal..... | 44 |
| 4. | UPPERSTRUCTURE COMPONENTS AND USE | |
| 4.1. | Tipping Silo (SSK)..... | 45 |
| 4.1.1. | Overview to the Superstructure Components on Tipping Silo | 46 |
| 4.1.2. | Loading / Discharging System | 47 |
| 4.2. | Non-Tipping Silo (SSL)..... | 58 |
| 4.2.1. | Overview to the Superstructure Components on Non- Tipping Silo..... | 58 |
| 4.2.2. | Loading / Discharging System..... | 59 |
| 5. | TRANSPORTATION PROCESS | |

| | | |
|-----------|----------------------------------------------------------------------------------|----|
| 5.1. | Pre-Driving Checks..... | 64 |
| 5.2. | Semi-Trailer and Tractor Coupling..... | 64 |
| 5.3. | Cautions During the Parking and Stopping..... | 65 |
| 5.4. | Important Technical Considerations | 65 |
| 5.4.1. | Fire Extinguisher..... | 65 |
| 5.4.2. | Wheel Chocks | 66 |
| 5.4.3. | Modifications on the Trailer..... | 66 |
| 5.4.4. | Air Leakage..... | 66 |
| 5.4.5. | Welding | 66 |
| 5.4.6. | Considerations For the Environment | 66 |
| 5.5. | Cleaning of the Vehicle | 67 |
| 6. | TRANSPORTATION SOLUTIONS | |
| 6.1. | Customs Legislation..... | 70 |
| 6.1.1. | Semi-Trailer Structure Compliant with Customs Legislation..... | 70 |
| 6.2. | Dangerous Goods Transportation (ADR) | 70 |
| 7. | LOADING AND LOAD SECURITY | |
| 7.1. | Loading and Discharging Tipping Silo Vehicle | 71 |
| 7.1.1. | Safety Precautions..... | 71 |
| 7.1.2. | Load Distribution and Load Limits of Tractor – Semi Trailer Combination | 71 |
| 7.1.3. | Considerations During Loading – Unloading | 72 |
| 7.1.4. | Loading Preparation..... | 72 |
| 7.1.5. | Loading | 73 |
| 7.1.6. | Discharging | 74 |
| 7.2. | Loading and Discharging Silo Vehicle..... | 81 |
| 7.2.1. | Safety Precautions..... | 81 |
| 7.2.2. | Load Distribution and Load Limits of Tractor – Semi Trailer Combination | 81 |
| 7.2.3. | Considerations During Loading – Unloading | 81 |
| 7.2.4. | Loading Preparation..... | 82 |
| 7.2.5. | Loading | 83 |
| 7.2.6. | Discharging | 84 |
| 7.3. | Ferry Rings..... | 86 |
| 8. | INSPECTION AND MAINTENANCE | |
| 8.1. | Safety Instructions..... | 87 |
| 8.2. | Main Principles | 87 |
| 8.3. | Checks to Be Performed Of The Time of the Delivery | 87 |

| | |
|----------------------------------------------|----|
| 8.4. Manhole Covers | 87 |
| 8.4.1. Gaskets | 88 |
| 8.5. Discharge Cone | 88 |
| 8.6. Periodic Maintenance and Controls | 88 |
| 8.7. Important Warning! | 89 |
| 8.8. Trouble Shooting..... | 89 |
| 8.8.1. Safety Instructions..... | 89 |
| 8.8.2. Spare Tire Replacement | 90 |
| 8.8.3. Hydraulic System Maintenance | 91 |

FOREWORD

First of all, thank you for choosing us for your new vehicle investment.

Your vehicle is manufactured with the latest production technologies to the highest quality standards and equipped with the best safety and efficiency features.

You can find detailed information about the accessories, equipment and hardware that might be in your vehicle in this manual. The defined options in this manual can vary according to the vehicle specs.

Important information on how you can use your vehicle is explained in this user manual, please be sure that you review and understand the content. We suggest keeping this user manual available in your vehicle at all times. This information is specified in the product's user manual. We recommend you read this operating manual thoroughly to get the most out of your vehicle.

** Owing to the developments in product research, the manufacturer reserves the right to make any changes in the product, without any prior notice. The publication rights of this documentation belong to the manufacturer.*

1. GENERAL INFORMATION AND SAFETY INSTRUCTIONS

1.1. About the User Manual

The usage and operation information given in this manual is prepared to make sure the vehicle is used in compliance with its purpose and as desired.

The instructions here contain important recommendations to perform your operations safely, completely, and in the most efficient manner. Complying with these instructions, warnings and recommendations will prevent accidents, decrease down-time & repair costs, and make sure you use your vehicle safely, reliably and problem-free.

Please read the operating instructions in this manual carefully and completely. The manufacturer is not liable for the damages and deficiencies caused by the failure to comply with these instructions. The instructions herein must be supported by local laws, rules and regulations. Please comply with these instructions to prevent accidents and protect your surroundings and the environment.

Any usage of transportation that goes beyond the use in accordance with the rules will be considered improper use.

Transportation of the following is not allowed:

- Carrying people and live animals
- Transportations that need to be carried according to special instructions, e.g., dangerous good transportations
- Transportation of unsecured goods
- Transportation of materials that are dangerous due to their properties or that need to be carried with special equipment
- Exceeding technically and legally permissible weights of the axles or king pin load

- Exceeding of the maximum vehicle speed
- Exceeding the permissible length, width and height
- Unapproved parts like tires, accessories, spare parts and etc. by the manufacturer
- The manufacturer shall not accept any responsibility for the problems and faults that occurs that are not in compliance with the purpose of the vehicle's usage. All the risks of this issue belong to the customer.

 **It is necessary to keep the user manual available on the vehicle at all times.**

 **The vehicle can be equipped with a lot of different options. The standard or optional features will be explained in the manual. Some options may not be available for your vehicle**

 **Adhere strictly to the operating instructions when using your vehicle. When problems occur which can lead to dangerous consequences, contact the service centre immediately.**

1.2. Meanings of Symbols Used in User Manual

Several warnings are available in this manual to ensure maximum safety when using your vehicle. Each warning is indicated by a special symbol. These symbols and their meanings are as follows.

 The information specified by this warning symbol is very important for health and human safety. When the given information is ignored, serious damage, injuries and even death may occur.

 This symbol specified in this manual indicates that critical accidents may occur when the instructions do not comply.

 This symbol is used when additional information is required.

 This symbol is used when chemicals and other substances can be disposed of with precautions that will not harm the environment.

1.3. Personal Protective Equipments

Personal protective equipments serves the purpose of preventing injuries and are prevents injuries and are determined by regional regulations depending on the load carried.

People who will work or perform operations on the vehicle must wear proper and appropriate protective clothing.

- Depending on the load to be carried, the eyes, ears, body, and respiratory tract must be protected with the relevant protective equipment.
- As a rule, gloves and work shoes are always used.

 It is obligatory to use appropriate personal protective equipment during the operations.

 Long hair is particularly dangerous when working on the vehicle, regardless of whether it is loose or tied up, and it should be protected properly to avoid tangling.

 Wearing a tie, necklace and/or dangling jewelry when working on the vehicle is strictly prohibited. They may get caught in moving parts or mechanisms and cause injuries and even death.

Protective Gloves

 During the operation, protective gloves must be used. Please make sure you are using the correct type of gloves when you are working with hot parts or chemicals.

 Gloves should fit snugly. Otherwise, there is a risk of them getting caught in moving parts or mechanisms.

Protective Cloth

 While working on the vehicle, appropriate overalls must be worn.

- Overalls should not have pleats, buttons or external pockets and their closure system should be made in such a way that they can be opened as soon as possible in case of an emergency.
- Interior pockets should have fastenings to close them up. Cuffs should be adjusted to fit the wrist.

Protective Helmets



When working around the vehicle, a lightweight helmet approved by an accredited institution should be worn.

Protective Ear Plugs



A hearing protective device (headsets or ear plugs) should always be used around self-propelled vehicles.

Protective Goggles



Protective goggles should be worn during all maintenance operations.

Protective Mask



Appropriate protective masks should be used when working with substances that are dangerous to breathe or in dusty environments.

1.4. Terms of Use and Safety Information

It is necessary to keep the warranty, operating and maintenance manual and other documentation about the vehicle available on the vehicle at all times.

1.5. Possible Dangers

Your silo vehicle has been designed using the most up-to-date technology and in compliance with generally accepted technical safety regulations and rules. Nevertheless, its use could involve risk of injury and death to the user and to others and damage to the vehicle itself and to other objects.

Below is a summary of dangers that can occur while working with the silo vehicle. It is recommended to read these dangers entirely.

| Danger Source | Consequences |
|-------------------------------------------------------|--------------------------------------------------------------------------------------------------------------------------------------------------------------------------------------------------------------------------------------------------------------|
| <p>Components transferring pressurized air</p> | <p>Risk of burns!</p> <p>Components conducting pressurized air can reach temperatures above 100 °C when in operation, and will cause burns if touched.</p> <p>Do not forget to wear protective gloves when you pressurize the connections.</p> |

To prevent possible accidents and environmental pollution, follow the operating instructions and binding regulations.

- Pay attention to the safety and warning signs placed on your vehicle.
- Always keep these safety and warning signs completely visible.
- Make sure that the load carrier is secured properly.
- In case of any dangerous condition in the operation of safety, stop your vehicle immediately and inform the authorized people or institutions.
- Do not modify anything on the vehicle without a written manufacturer's approval. Your vehicles guarantee terms do not cover unapproved modifications.
- The spare parts must meet the technical requirements set forth by the manufacturer company. Only the original spare part/parts meet their requirements.

| | |
|-----------------------------------------------------------------|---------------------------------------------------------------------------------------------------------------------------------------------------------------------------------------------------------------------------------------------------------------------------------------------------------------------------------------------------------------------------------------------------------------------------------------------------------------------------------------------------------------------------|
| <p>Loose hoses when compressed air is being released</p> | <p>Danger of injury!</p> <p>Loose hose ends can cause physical injury</p> <ul style="list-style-type: none"> • Only apply pressure to the system when the hoses are connected at both ends tightly. • • Only allow compressed air to escape when no hoses are connected. |
| <p>Pressurized silo tank and manhole</p> | <p>Danger of fatal injury!</p> <p>If you loosen or tighten the manholes under pressure, the manhole can tear away explosively from the silo tank and hit you or other people.</p> <p>Never attempt to open the clamps of a pressurized manhole.</p> <p>Don't remove the blind cover from a coupling that is under pressure. Connect the material hoses before the system is pressurized.</p> <p>Never attempt to loosen or tighten the clamps of a discharge cone that is under pressure.</p> |

| | |
|-------------------------------------------------------------------------|------------------------------------------------------------------------------------------------------------------------------------------------------------------------------------------------------------------------------------------------------------------------------------------------------------------------------------------------------------------------------------------------------------------------------------------------------------------------|
| <p>Contact with the load when unloading, loading or cleaning</p> | <p>Health risk!</p> <p>Under certain conditions, the load can be dangerous to health if inhaled or it comes into contact with the skin or eyes.</p> <p>Avoid physical contact with the load. Avoid inhaling any dust that may escape.</p> <p>Wear protective clothing according to the type of the load.</p> <p>If the load causes an injury, consult the material's safety data sheet for the remedial action that needs to be taken.</p> |
| <p>Friction of the load against the tank wall and fittings</p> | <p>Danger of fire and explosion !</p> <p>If the potential conductor is not connected, static charges can cause sparks and thus explosions.</p> <ul style="list-style-type: none"> • Connect the potential conductor while filling, discharging and cleaning. |
| <p>Rolling and drifting while raising/lowering the silo tank</p> | <p>Danger of fatal injury!</p> <p>Raise/lower the silo vehicle at a steady speed.</p> |
| <p>Hose couplings</p> | <p>Danger of injury!</p> <p>A load that is being discharged under pressure can cause serious injury to the face and body</p> <ul style="list-style-type: none"> • Never loosen hose couplings while filling or emptying. • Always tighten the hose couplings carefully and secure them with the safety clips. |

| | |
|------------------------------------------|----------------------------------------------------------------------------------------------------------------------------------------------------------------------------------------------------------------------------------------------------------------------------------------------------------------------------------------------------------------------------------------------------------------------------------------------------------------------------------|
| <p>Raising the silo vehicle</p> | <p>Danger of fatal injury !</p> <p>The silo vehicle can roll over if it is not standing firmly.</p> <ul style="list-style-type: none"> • Make sure that the ground surface is even. • Always deploy the rear landing gears (if equipped). • Lower the silo vehicle's air suspension completely. • • Do not alter the position of the rear landing gears while the silo vehicle is raised. |
| <p>Strong winds or storms</p> | <p>Danger of fatal injury!</p> <p>With the silo vehicle raised, it can tip over in strong winds.</p> <ul style="list-style-type: none"> • Do not raise the silo tank when the wind speed is above 40 km/h. • Lower the silo tank immediately if the wind speed rises above 40 km/h. • Do not raise the silo vehicle when it is not connected to tractor. |
| <p>Compacted load</p> | <p>Danger of skidding!</p> <p>Product that becomes compacted will destabilize the raised silo tank, and if there is sudden slippage, the silo vehicle can be thrown backwards or sideways.</p> <ul style="list-style-type: none"> • Avoid repeated raising and lowering of the silo tank, because this can cause the load to compact. |
| <p>Contact with hydraulic oil</p> | <p>Danger to health!</p> <p>Under high pressure, hydraulic oil can escape and cause burns or poisoning.</p> <ul style="list-style-type: none"> • Avoid physical contact with the hydraulic oil. • Do not loosen hydraulic hoses when the hydraulic system is under pressure. |

| | |
|-----------------------------------------|---------------------------------------------------------------------------------------------------------------------------------------------------------------------------------------------------------------------------------------------------------------------------------------------------------------------------------------------------------------------------------------------------------------------------------------------------------------------------------------|
| <p>Entering the silo vehicle</p> | <p>Danger of fatal injury!</p> <p>Entering the interior of the silo tank to inspect, maintain, clean or for other purposes can be a seriously dangerous to health. (This is a situation that changes according to the material.)</p> <ul style="list-style-type: none"> • Only enter to the silo tank if it is absolutely necessary. • Before entering the silo tank, perform a gas measurement according to the applicable regulations. |
|-----------------------------------------|---------------------------------------------------------------------------------------------------------------------------------------------------------------------------------------------------------------------------------------------------------------------------------------------------------------------------------------------------------------------------------------------------------------------------------------------------------------------------------------|

1.6. Danger Areas

This section is an overview of the areas on and around the silo vehicle where there is an increased risk to yourself or others.

| <p>Danger area</p> | <p>Action to be made</p> |
|--------------------------------------------------------|----------------------------------------------------------------------------------------------------------------------------------------------------------------------------------------------------------------------------------------------------------------------------------|
| <p>Between the tractor and the silo vehicle</p> | <p>When attaching and separating the silo vehicle and the tractor, there is a danger of people getting trapped or run over between the tractor and silo vehicle.</p> <ul style="list-style-type: none"> • People should be kept away from the danger area. |
| <p>The walkway on the silo vehicle</p> | <p>Climbing onto the walkway without the handrail is opened, there is a danger of falling from the silo tank.</p> <ul style="list-style-type: none"> • Always open the handrail before climbing onto the walkway. |
| <p>The walkway on the silo vehicle</p> | <p>Climbing onto the silo tank when it is under pressure involves an increased risk.</p> <ul style="list-style-type: none"> • Only climb onto the the pressurized silo tank if it is absolutely necessary. |

| | |
|---------------------------------------------|----------------------------------------------------------------------------------------------------------------------------------------------------------------------------------------------------------------------------------------------------------------------------------------------------------------------------------------------|
| <p>Around the silo vehicle</p> | <p>The presence of unauthorized persons around the vehicle during loading and unloading operations constitutes an unnecessary risk for the safety of yourself and others.</p> <ul style="list-style-type: none"> • Instruct unauthorized persons to leave the silo vehicle's danger area. |
| <p>Beneath a separated silo tank</p> | <p>In certain circumstances, separated silo tank can suddenly drop, thereby injuring persons.</p> <ul style="list-style-type: none"> • Therefore, never stand behind a silo tank separated from the trailer. • For maintenance work, the silo tank should be secured with suitable mechanical devices. |

1.7. Weather Conditions

Depending on weather conditions, make sure the vehicle is free from snow and ice at temperatures below zero. Clean the snow or ice in the vehicle. Do not put yourself in danger during this process.

2. MAIN INFORMATIONS

There are vehicle identification stickers on the vehicle.

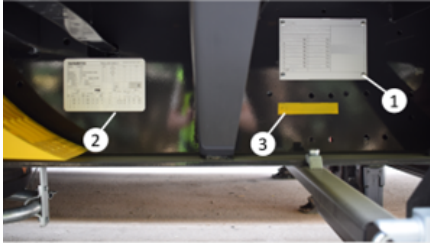

2.1. Vehicle Identification Plate

Vehicle identification plate is located on the right side of the vehicle.

You may find the following information's on this plate;

| | | | |
|------------------------|-------------|--|--|
| 1 xxx"xxxx/xx"xxxx | | | |
| 2 xxxxxxxxxxxxxxxxxxxx | | | |
| 7 xx.xxx kg | 3 xx.xxx kg | | |
| 8 xx.xxx kg | 4 xx.xxx kg | | |
| 1 x.xxx kg | 5 x.xxx kg | | |
| 2 x.xxx kg | 6 x.xxx kg | | |
| 3 x.xxx kg | 5 x.xxx kg | | |
| 4 - kg | 5 x.xxx kg | | |
| 5 - kg | kg | | |
| T - xx.xxx kg | 6 xx.xxx kg | | |
| Type: xx | 11 | | |

Vehicle Identification Plate

- 1- Type approval number
- 2- VIN number
- 3- Technical total capacity
- 4- Technical king pin capacity
- 5- Technical an axle capacity
- 6- Technical total axle capacity
- 7- Nationally approved total capacity
- 8- Nationally approved king pin capacity
- 9- Nationally approved an axle capacity
- 10- Nationally approved total axle capacity
- 11- Vehicle Type

Vehicle Identification Plate

2.2. Brake Data Plate

There is a brake data plate (2) on the vehicle which is equipped with an EBS system.

You may see this information on this plate.

EBS Plate

| | |
|---|------------------------------|
| 1 | Empty vehicle (without load) |
| 2 | Loaded vehicle |
| 3 | Axle lifting |
| 4 | Brake chamber data's |
| 5 | References |
| 6 | Driving height |
| 7 | Pin positions |
| 8 | IN/OUT-Connections |

2.3. VIN (Chassis) Numbers

The VIN (chassis) number is located on the right side of the vehicle and marked with a different color than the chassis color.

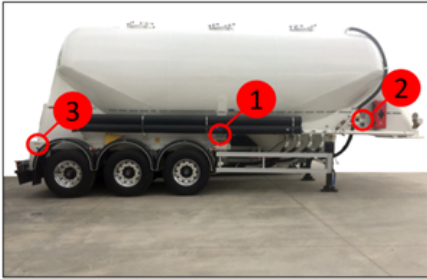

- 1- Vehicle identification plate
- 2- Brake plate
- 3- VIN Number

2.4. Warranty and Responsibility

Our trailers, semi-trailers and truck on-board applications are manufactured in compliance with regulations and our quality standards. It is necessary to perform the maintenance to ensure our products always operate in the most efficient manner in compliance with our latest directives and maintenance programs. The warranty starting date is

the date that the vehicle is delivered to the customer.

The performance of maintenance and repair/servicing of the vehicle with the use of original spare parts by authorized service shall assure the client's warranty rights. This warranty is based upon the usage and maintenance conditions described herein and in the warranty book. Thus, it is important to read and understand this operation manual and warranty book.

It is necessary to keep the warranty, always operating and maintenance manual available on the vehicle to allow authorized service performing the servicing to see the warranty conditions and maintenance records. In the repairs made during the warranty period, the authorized service performing the repair will demand this. Purchasing one trailer or semi-trailer is an important investment. For the highest return on your investment, it is necessary to comply with the manufacturer's procedures and recommendations during the operation period of the vehicle. The information provided by the client/driver related to the warranty written in this manual shall be kept within our database.

3. TRAILER RUNNING GEAR AND USAGE INSTRUCTIONS

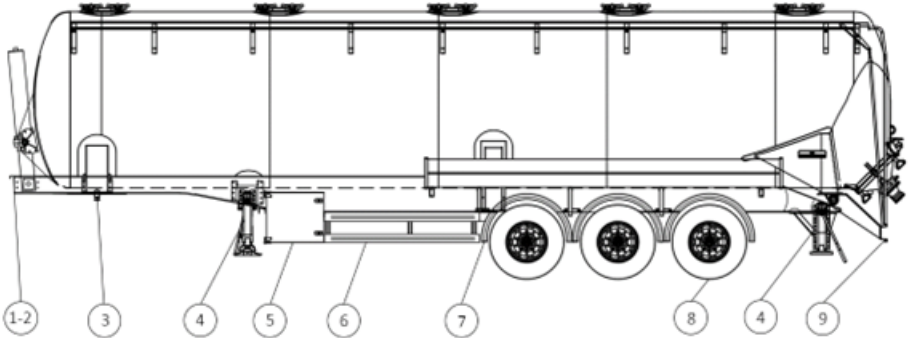

1-2 Brake/Electric Connections

3 King Pin

4 Landing Legs

5 Toolbox

6 Side Protection

7 Mudguard

8 Tire

9 Bumper

3.1. Brake System

3.1.1. Air Couplings

The main connection between the truck and trailers is air couplings.

Generally, 3 different types of air couplings are used in the trailers. These 3 types of air couplings have the same function but with different shapes and connections. There are 2 different air supply lines in the system.

- Brake Line (Yellow)
- Supply Line (Red)

Service Line: Pneumatically air hose which will feeds the brake line.

Supply Line: Pneumatically air hose which will feeds the air tanks and trailer.

According to the type of vehicle, your vehicle can be equipped with one or two different types of air couplings.

- Standard Couplings (Palm)
- Duomatic Coupling
- C (UK) Couplings



If your vehicle is equipped with 2 different types of couplings, you must use only one type at the same time.



When the couplings are mounting/demounting, the parking brake of the truck and trailer must be engaged.



If the brake parameters are modified, your vehicle's brake calculation might be non-suitable for regulations. Only authorized services must service to the EBS modulator.



Only authorized services and personnel should make service operations for the brake system.

There might be test points on the chassis or above the air couplings. When you remove the test points rubber protection parts and push the points you can check the air pressure on the brake lines.

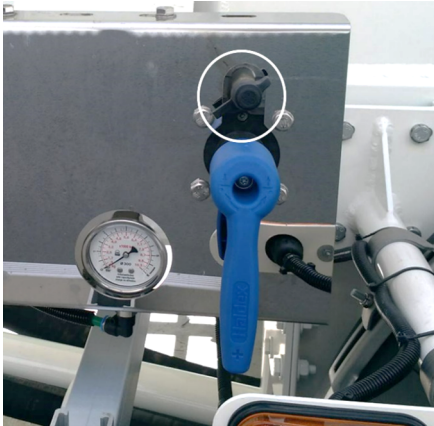

Test point



Palm coupling with a test point

3.1.1.1. Mounting of Standard (Palm) Couplings



Couplings

- Slightly slide plastic covers to the upper side. Slide plastic covers to upper side.
- Be sure that sealing surfaces are clean and durable. If necessary, clean/change the air coupling.

- The coupling which comes from the truck should be pushed slightly from the upper side to the lower side and connect the coupling. Be sure that couplings are matched correctly.
- First mount service line yellow (1).
- Mount supply line red (2).

3.1.1.2. Demounting of Standard (Palm) Couplings

- The coupling which comes from the truck should be pushed slightly from the lower side to the upper side and demount the coupling.
- First demount the supply line red (2).
- Demount the service line yellow (1).
- Slightly slide plastic covers to the lower side and close the plastic covers.

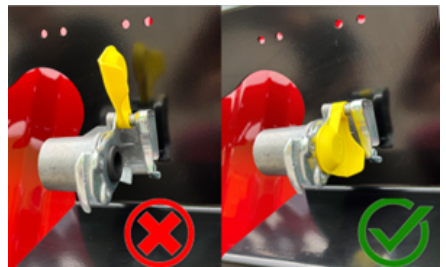

Closing the coupling



Driving with a non-suitable air connection is dangerous and forbidden.



Using damaged air supply parts can cause serious hazards. Torn or damaged compressed air connectors reduce the vehicle's braking performance.

3.1.1.3. Mounting of C (UK) Couplings

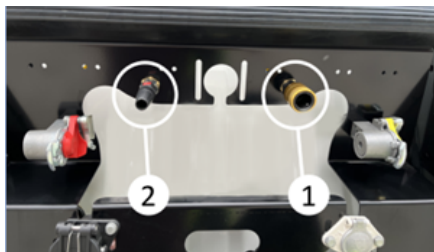

Mounting the C (UK) Couplings

- Be sure that sealing surfaces are clean and durable. If necessary, clean/change the air coupling.
- First mount service line yellow (1).
- Mount supply line red (2).
- Be sure that couplings are matched correctly.

3.1.1.4. Demounting of C (UK) Couplings

- Push the latch from front to back side on the C couplings and remove.
- First demount the supply line red (2).
- Demount the service line yellow (1).



The coupling filters have to be clean regularly.

3.1.1.5. Mounting of Duomatic Coupling



Duomatic Coupling Connection

- Be sure that sealing surfaces are clean and durable. If necessary, clean/change the air coupling.
- Push the arm and mount the coupling (1).



The coupling filters must be clean regularly.

3.1.1.6. Demounting of Duomatic Coupling

- Push the arm and mount the coupling (1).
- Pull back the arm slightly and close the coupling cover.

3.1.2. Compressed Air Tanks

Pressured air can be stored in the air tanks.

The quantities and capacities of the air tanks can be changed according to your vehicle specifications.

In cold periods of the year or when the air humidity is high, the moisture in the air can be condensed and collected in the compressed air tank.

The tractors are generally fitted with air driers to prevent condensation in compressed air. The tractors are generally

fitted with air driers to prevent condensation in compressed air. Even if the air driers system, the humidity in the air can be condensed. The condensed water must be drained out via the drain valve.

The water in the air tanks should be completely drained out. That's why please push the valve on the air tanks.

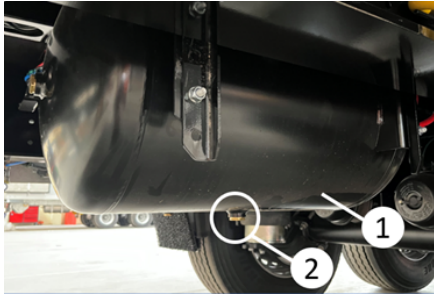

- 1. Compressed Air Tanks
- 2. Drain valve

 The water in the compressed air tank can cause corrosion problems and affect the functionality of the brake system. The frozen water in the pneumatic lines can cause the failure of the brake system.

 The water in the pneumatic system should be checked more frequently in cold weather or extremely variable outside temperatures.

 When the air tank pressure is lower than 4,5 bars, the EBS warning lamp on the tractor turns on and the driver can see this situation.

 When the pressure in the service line (in the red coupling) is lower than 2,5 bars, the brakes automatically lock.

3.1.3. EBS Socket



EBS Socket

Our trailers and semi-trailers are equipped with an EBS system.

EBS is an electronically controlled brake system, that is fitted with automatic load sensing braking pressure regulation (ALB) and automatic anti-skid systems (ABS/ABV).

To activate the EBS system, your truck and trailer must be equipped with an EBS system. Please mount the EBS cable that will come from the truck to the EBS socket on the trailer.

- Driving with a non-connected EBS connection is illegal.
- Drive only with an approved and well-operating EBS plug connection in accordance with regulations.
- EBS connection must be made between the truck and trailer.
- When the EBS socket mounted and truck engine is activated, you will hear the noise. Please listen and check carefully.
- A system control is performed two seconds after the trailer EBS is switched on; in the meantime, the magnets may be opened and closed audibly for a short time. When plugging the EBS connector, if you cannot hear the system control, a power supply problem exists between the tractor and EBS.

When the truck engine is activated and during the travel, the EBS system will be checked automatically. If the truck screen is suitable/adjusted, the EBS failures will be shown with the EBS mistake lamp.

The EBS mistake lamp on the truck screen will be turned on when the ignition key is activated. If there is no failure on the EBS system, the lamp will be turned off in appr. 2 seconds.

After 7 km/hour speed, if there is a failure on the EBS system (Sensor mistake and etc.) EBS lamps will be flashed.

If the EBS lamp is activated, please contact with authorized services immediately.

 **The trailers equipped with a Trailer EBS E braking system may only be used with tractors with.**

- ISO 7638-1996 connectors (ABS + CAN) or ISO 7638, 7 pin with CAN data line (EBS Truck)

 **If you drive without EBS connectors or if there is a problem on the EBS system, the brake system will not be worked properly. This situation may cause an accident.**

 **Trailers are equipped with an additional power supply for the EBS system. Thanks to the extra power supply from brake lamps, when the EBS connector is damaged, an extra safety function will be activated. The EBS system will be fed from brake lamps and ALB (automatic load sensing braking pressure) and ABV (anti-skid system) functions will be activated.**

3.1.4. Roll Stability Support (RSS)

Rollover stability support (RSS) is integrated into the trailer modulator. But don't forget that this system cannot cancel the laws of physics. The vehicle's electronic control unit analyzes wheel speed, load information and transverse acceleration data to detect the likelihood of vehicle roll-over before the driver realizes there is a risk and automatically applies the brakes. But don't forget that this system cannot cancel the laws of physics.

When the roll-over risk is detected, the EBS system makes automatically brakes and tries to reduce the roll-over risk. After risk, the RSS function will be shut down automatically.

 **The RSS optimizes driving characteristics and in emergencies may help to prevent accidents. But cannot completely guarantee.**

3.1.5. PREV (Park Release Emergency Valve)

Generally, brake control systems will be located on the driver's side. It may be different on your vehicle according to the vehicle's construction.

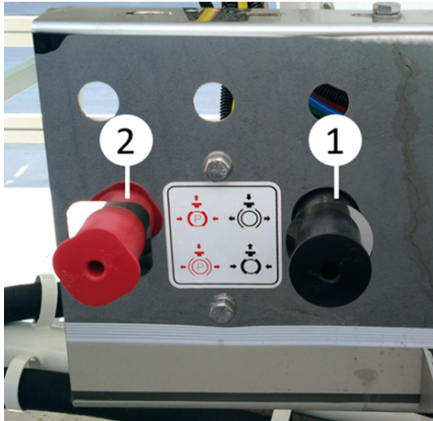

PREV Buttons

Black button (1): Service brake button.

Red button (2): Park brake button



When you are driving the trailers, the red button must be pushed position and the black button has to be pulled position.

3.1.5.1. Service Brake

Thanks to the service brake, the trailer can be made maneuvers without air connections. The black button can be used only without air connections on the trailer.

When you push the black button, the service brake will be disabled. When you pull the black button, the service brake will be activated.



If the service brake is used a lot of times, without an air connection, air pressure in the system and braking power may reduce.

When the air connections are de-mounted, the service brake will be automatically activated. When the air connections are mounted, the service brake will be automatically disabled.

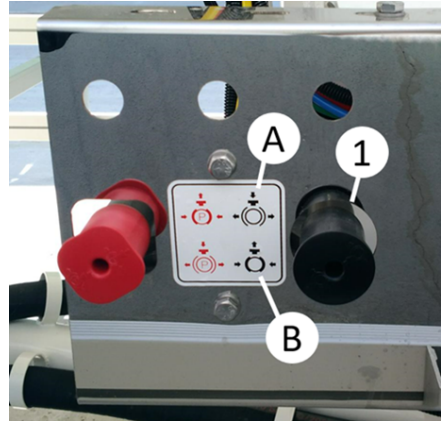

Service Brake



The service brake is not suitable for brak-ing of the semi-trailer permanently. During longer waiting periods, the semi-trailer must be secured with a spring-loaded park brake and with wheel chocks.

3.1.5.2. Spring Loaded Park Brake

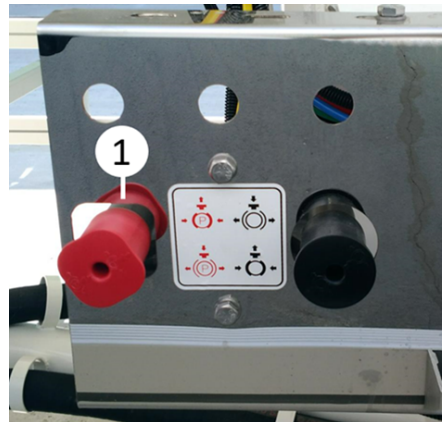

Spring loaded park brake

Spring loaded park brake control button is used for longer parks of semi-trailers with or without tractor on plain or inclined lands.

When the red button is pulled, spring loaded park brake will be activated. When the operator pushes the red

button, spring loaded park brake is deactivated.



This brake will not be deactivated automatically. Before driving, the operator must deactivate the brake.

3.1.6. Brake Chambers

Your vehicle may be equipped with disc or drum brake axles according to your choice. For both brake types, the brake chambers are going to use for braking. The brake chambers will be chosen according to axles type and loading capacity. The maintenance, modification or repair operations must be performed by authorized services.

3.1.6.1. Manually Deactivation of Parking Brake Spring

The Parking brake spring may be deactivated manually in emergency situations.

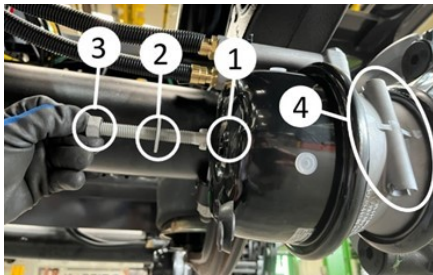

Deactivation of brake chambers

1. Boreholes

2. Release rod

3. Nut

4. Slot of the release rod

- Remove the release rod (2) from the slot (4).
- Insert the release rod (2) to boreholes (1) and screw till the rod (2) will be fitted completely.
- Completely screw in the nut (3) to the release rod (2).

The brake chambers will be deactivated after this operation. In this case, the brake chamber only works on the service brakes. Even if the trailer air tube pressure drops below 2.5 Bar, the spring brake will not be activated due to this operation.



On some brake chambers used in vehicles, the emergency release screw is located in its socket (1) behind the brake chamber, not in its socket (4) next to it. In order to disable the springs, it is allowed to come out by simply turning it with the appropriate key.



This operation should only be used until the trailer is serviced.



Before this operation, the vehicle must fixed securely with wheel chocks. Serious injuries may occur.

3.1.6.2. Activation of Brake Chambers

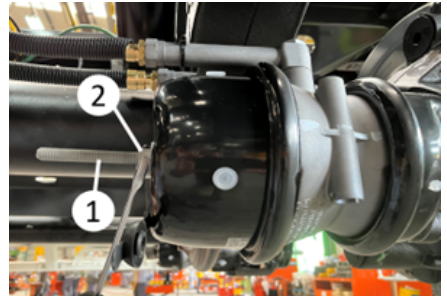

Activation of brake chambers

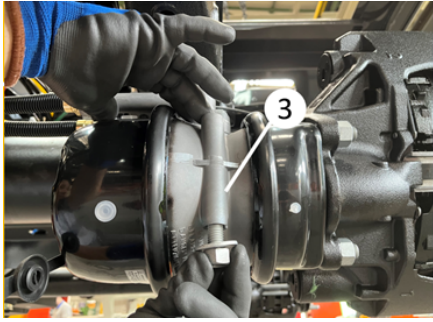

- Remove the nut (1) from release rod (2) with a spanner.
- Remove the release rod (2).
- Screw the release rod into its place on the brake chambers (3)
- Close the plastic cover on the brake chamber.

Brake chamber will be activated after this operation.

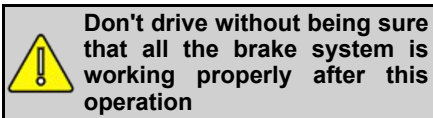
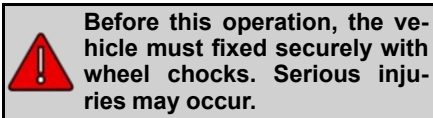

3.2. Suspension System

Your vehicle is equipped with air suspension system.



When entering uneven or damaged roads, the fifth-wheel plate height and the trailer should be raised. Otherwise, the front part of the trailer may come into contact with the tractor, or trailer components may be damaged. While raising the vehicle, check the external height and make sure it does not hit anything. Comply with legal height limits. Once the problematic area has been passed, the vehicle should be returned to driving height.

3.2.1. Manual Control Lever

Operation;

In the driving position, the air suspension system keeps the semi-trailer permanently at a certain level independently from the load. The lowering/raising lever (1) at the control panel can lower or raise the semi-trailer. for ramp adjustment on the loaded position.

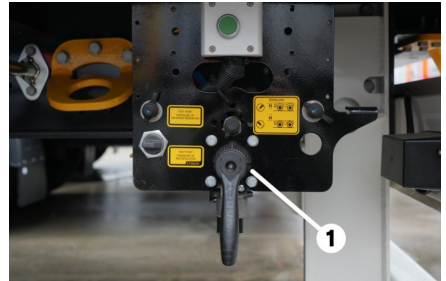

Driving position of lever

You may turn the lever according to anti-clockwise and raise the trailer.

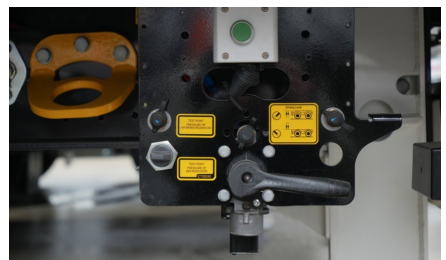

Raising of suspension

You may turn the lever according to clockwise and lower the trailer.

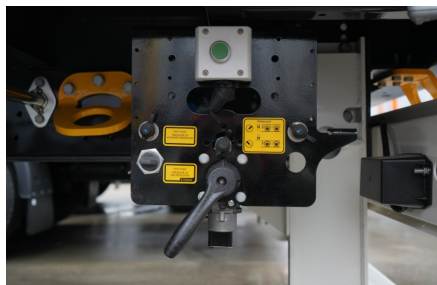

Lowering of suspension

To fix the suspension height, you may turn the lever 45° or 135° according to the photo in below. Before driving, the lever must be switched to driving position.

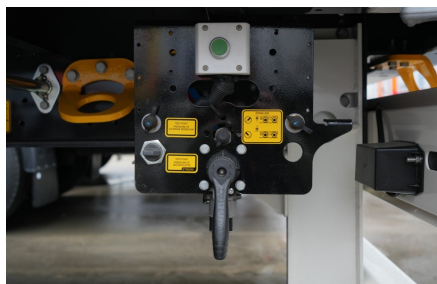

Fixing of suspension height

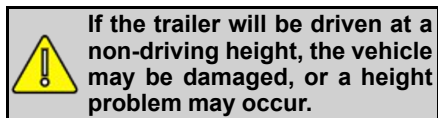

3.2.2. Auto Reset

The auto reset lever can be controlled by the same method as 3.2.1. manual suspension control lever. When the EBS socket is mounted and driving at a speed defined by the producer, the lever will set the driving height automatically.

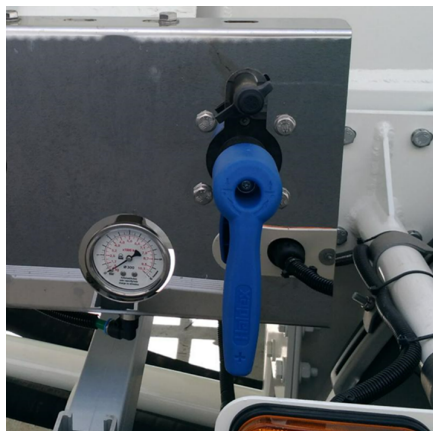

Auto reset

3.2.3. Electronic Controlled Air Suspension (ECAS)

Electronic controller air suspension (ECAS) is an optional solution. This system sets the driving height or defined different heights electronically. When the EBS socket is mounted and driving at a speed defined by the producer, the lever will set the driving height automatically.

You may push the lower or raise button and set the vehicle height.



ECAS control panel

3.3. Electrical System

15 pin (1), 2x7 pin (2) or 15 pin+2x7 pin (1+2) electrical sockets are option in our vehicles. Thanks to these sockets,

electrical connections between truck and trailer will be made.

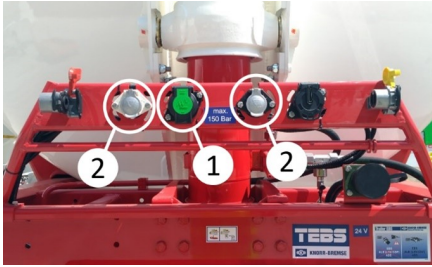

Electrical system

When driving, the electrical sockets between the truck and trailer must be connected.

Please be sure that the truck and trailer are suitable for the norms/standard about electrical systems. Otherwise, electrical problems will occur.

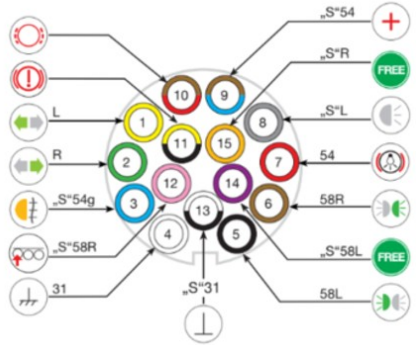

| Pin | Meaning |
|-----|------------------------------|
| 1 | Left indicator |
| 2 | Right indicator |
| 3 | Fog lamp |
| 4 | Ground |
| 5 | Left taillight |
| 6 | Right taillight |
| 7 | Brake light |
| 8 | Reverse light |
| 9 | Supply line |
| 10 | Brake Lining Wear |
| 11 | Traction help/Force Lowering |

| | |
|----|---------------------|
| 12 | Axle Lift |
| 13 | Chassis Electronics |
| 14 | Empty |
| 15 | Empty |

3.3.2. 2x7 Pin Socket

This system provides electricity for the electrical system on the vehicle like stop lamps, signal lamps etc. 2x7 pin socket pin connections are made suitable for 24S ISO 3731 and 24N ISO 1185 norm.

Open the protection cover and mount the sockets regularly.

You may find extra information about the pins function in below.

| | |
|---|-----------|
| 5 | Empty |
| 6 | Axle Lift |
| 7 | Fog lamps |

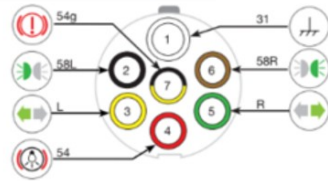

ISO 1185 Soker



ISO3731 Soker

| Pin | Meaning |
|-----|-----------------|
| 1 | Ground |
| 2 | Left taillight |
| 3 | Left indicator |
| 4 | Brake light |
| 5 | Right indicator |
| 6 | Right taillight |
| 7 | EBS |

| Pin | Meaning |
|-----|----------------|
| 1 | Ground |
| 2 | Empty |
| 3 | Reversing lamp |
| 4 | Supply line |



Please be careful with the color of the sockets. The black socket is suitable for ISO 1185 and the white socket is suitable for ISO 3731. If the vehicles are suitable for norms, the

black socket on the truck will be connected to the black socket on the trailer and the white socket on the truck will be connected to the white socket on the trailer.

3.3.3. Light System

The vehicle is equipped with a light system which is suitable for the regulations.

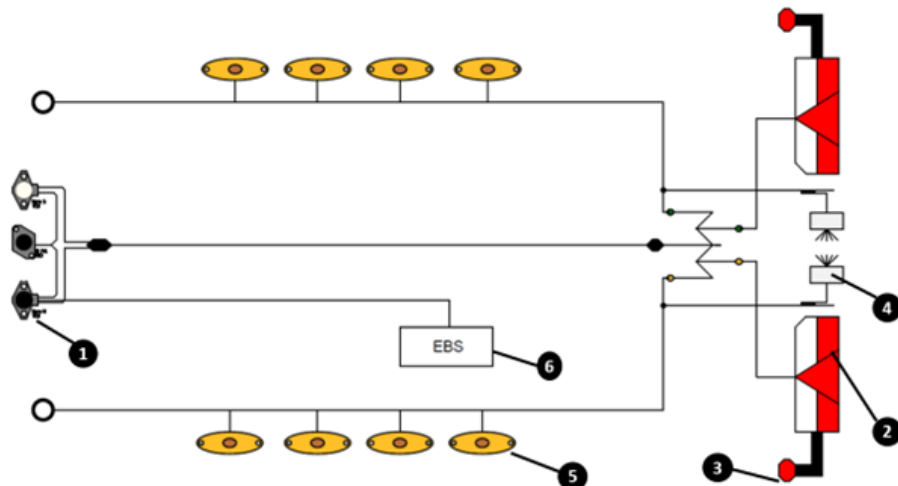

| | |
|---|---------------------|
| 1 | Electrical Sockets |
| 2 | Stop Lamps |
| 3 | End Outline Markers |
| 4 | License Plate Lamps |
| 5 | Side Position Lamp |
| 6 | Modulator |

The lamps must be checked regularly. If there is any problem with the electrical system, it must be repaired immediately. In a repair operations, only original and approved sockets or parts must be used.



If you add or remove any lamps on the vehicle, your vehicle may be non-suitable for regulations.



Vehicles with LED electrical systems consume very low energy. For this reason, although there is no problem in the system, it may cause the failure lamp to come on in old tractors.



Repairing operations of the electrical system have to be made by only authorized services. Otherwise, electrical problems may occur or your vehicle may be out of warranty.

3.4. King Pin

King pin is a shaft which connects truck and trailer together. Your vehicle may be equipped with 2" or 3.5" diameter pins. Please check the king pin diameter before connecting the truck.

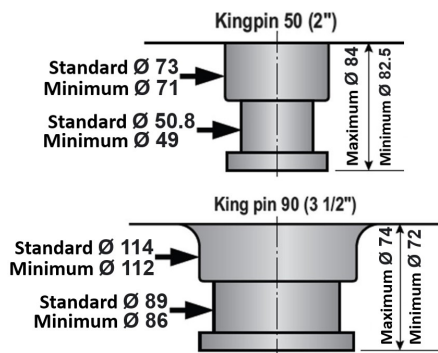

If you match the truck and trailer with a different diameter king pin, injuries may occur.

The flanged king pin is used on the vehicle. That's why king pin can be replaced easily.



Kingpin



If the wearing on the king pin is bigger than 2 mm, the king pin must be replaced.

Your vehicle may be equipped with a double king pin slot. You can remove the bolts around the king pin and mount king pin to the other slot. Please be careful about the total length of the vehicle according to country regulations and be sure that the total length is suitable for regulations.

3.5. Landing Gear

There is a front landing gears behind the vehicle's gooseneck area so that your vehicle can stop in park without truck.

3.5.1. Front Landing Gear's Working Principle

The landing gear crank handle (1) should be removed from its holder (2) and brought to a perpendicular position to the vehicle.



Landing Gear

Low Speed (A): When the crank handle (1) is turned in the fully pressed position, it raises / lowers at low speed.

High Speed (B): It performs high speed lifting / lowering when the lever turned in the fully extended position. The position is used to quickly lower the gear until the foot (plates) touch the ground during the process of separating the semi-trailer from the tractor, or to raise the gear quickly after the semi-trailer is connected to the tractor.



The landing gear crank handle is usually located on the passenger side of the vehicle.

 In all conditions, secure the semi-trailer against tipping with correctly positioned wheel wedges. If the vehicle is not properly secured, the landing gear or the vehicle may be damaged.

 If the loading / unloading operation is performed while semi-trailer is not paired with the tractor, the front or rear of the vehicle may raise. Serious accident and damaged may occur. For this reason, the semi-trailer must be paired with the tractor during the loading and unloading operations.

 If the tractor leaves from the loaded trailer, be sure that the load is distributed homogeneously in the vehicle. Otherwise, the front or rear section of the vehicle may be raised due to centre of gravity, and accident may occur.

In order to protect the landing gear, be sure that there won't be any lateral movements on your vehicle. For this reason give attention to the following criteria:

- Disconnect the semi-trailer from the tractor only when the landing gear are in the middle (neutral) position.
- If you will park for a long time without the coupled tractor, be sure that air suspensions are lowered and after that adjust the landing gears. Thus, the loading area will be parallel to the ground.



Landing gear view

Optionally, an aluminum landing gear can be supplied.



Before you start to drive operations, make sure that the landing gear is turned off (highest position).

3.5.2. Rear Landing Gear Working Principle

There may be landing gears at the back of the tipping silo trailer vehicles with a volume capacity of 45 m³ or more. These landing gears can be mechanical or hydraulic according to the customer's request. Unlike the front landing gears, the rear landing gears move independently of each other to ensure full stability of the vehicle on uneven ground. If the rear landing gears are mechanical, lowering and lifting is done by the lever - reducer device. If the rear landing gears can be lowered and raised hydraulically, the control is placed on the console where the tipping lowering - lifting lever is located just behind the right or left rear mudguards.

In the operation of the rear landing gear, the airbags must be placed on the landing gear in the driving position.

Remove the landing gear lever (1) from its holder (2) and bring it upright to the vehicle.

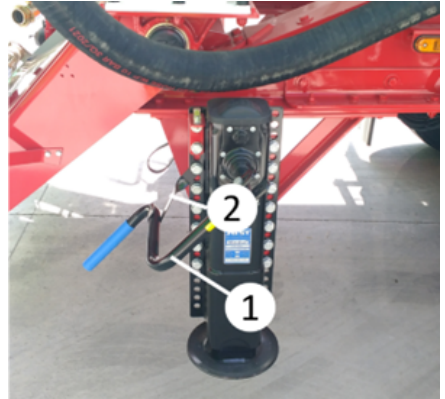

Rear landing gear

Low Speed (A): When the lever (1) is turned in the fully pressed position, it raises/ lowers at low speed. This position is used to lift the semi-trailer slightly and separate it from the tractor after the foot (plates) touch the ground, and to remove the load on the tractor.

High Speed (B): It performs high speed lifting/lowering when the lever turned in the fully extended position. The position is used to quickly lower the gear until the foot (plates) touch the ground during the process of separating the semi-trailer from the tractor, or to raise the gear quickly after the semi-trailer is connected to the tractor.

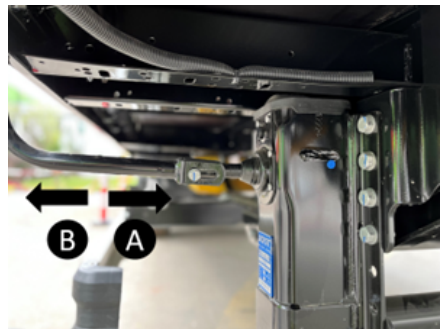

3.6. Side Protection Equipment (Underrun Protection)

The side protection equipment must be in the off position while driving. Some side protection equipment can be opened upwards to facilitate service

operations such as accessing the spare tire.

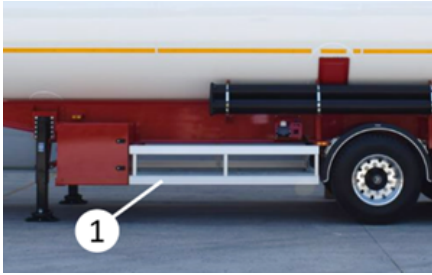

Underrun protection

 **Travelling with the opened underrun protection is dangerous and illegal. In this case, there may be serious injuries, including death, in road accidents that may occur. Before travel, make sure the underrun protection is lowered and properly secured.**

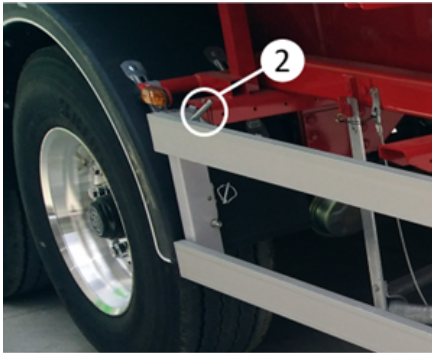

Pin

Removing Underrun Protection: After opening the protection release pins (2) on both sides, the underrun protection is removed and taken out.

 **If the underrun protection is not fixed properly, it may fall and cause injury.**

Installing Underrun Protection: Insert the protection into its slot from both sides and insert the pins.

3.7. Semi-Trailer Axle System

Axle with disc or drum type brake mechanism are used in your vehicles.

Semi-trailer axles may only be loaded with the maximum legally permissible axle load indicated on the vehicle identification plate. The user is responsible for use of the trailer in accordance with its purpose and capacity and for its maintenance.

The healthy operation the brake system of the semi-trailer depends on the use of the semi-trailer with the same system and/or compatible tractor. For this reason, its obligatory for the buyer to market he brake adjustment at the authorized service of the tractor company with which these semi-trailer / trailers will be matched. In case your vehicle is paired and used with tow tractors that are not or cannot be adjusted, malfunctions and damages that may occur in the brake system or in the entire tractor and semi-trailer are outside the responsibility in this regard belongs to the buyer.

 **For more detailed information about your axles, please refer to manufacturer's manual given to you at the time of delivery.**

 **If the axles are used other than the conditions specified in the manufacturer's manual or if their maintenance is interrupted, your vehicle may be out of warranty.**

 **If the vehicle is equipped with the emergency brake bellows, apply the parking brake after checking the brake drum temperatures. Never apply the parking brake when the drums are very hot.**

3.7.1. Self-Steering Axles

Your vehicle may be equipped with a self-steering axle to increase the maneuverability capacity during forwarding driving. This type of axle is usually

positioned at the rear axle of the vehicle and has a locking mechanism.



The turning radius of the vehicle which is equipped with a self-steering axle is different from standard vehicles. In addition, there will be differences in the maneuverability of the vehicle in cases where the self-steering axle is locked or unlocked. Please be careful about the self-steering axles.

3.7.1.1. Locking The Steering Axle

For vehicles with Electronic Braking System (EBS), the self-steering axle can be locked automatically when the reverse gear is engaged in order to reverse. It is also possible to lock this axle manually.

Drive the vehicle straight ahead so that the steering axle is in a straight position before the steering axles will be locked.

If the automatic axle locking function is active in your vehicle, the steering axle will be locked automatically when you engage reversing gear.

If you want to lock axles manually, make sure that the steering axle is in a straight position and close the valve (1) or turn the button to the off position.

The locking valve will be positioned towards you when the self-steering axle is locked manually.



Reversing with unlocked steering axles is dangerous. The semi-trailer can be separated from the tractor. Before going backwards be sure that self-steering axle is locked.

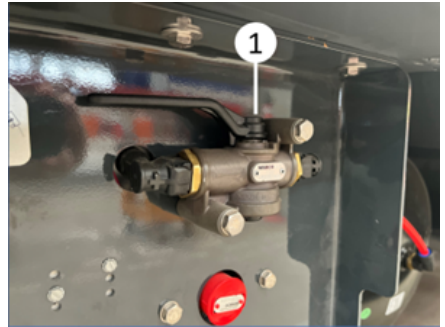

Self-Steering Axle Release Valve

3.7.1.2. Unlocking The Self-Steering Axle

The self-steering axles, which lock automatically when reverse gear is engaged, will automatically unlock when the vehicle is moving forward.

To release the manually locked self-steering axle, turn the valve handle 90° (2) clockwise or move the button to the open position.



When the self-steering axle is locked manually, the axle will not be unlocked automatically. It must be unlocked manually.



The Self Steering Axles Release Valve

3.7.2. Axle Lifting

Axle lifting feature is optionally available in different quantities and location in your vehicle. Thanks to this feature tire wear is minimized and a more balanced load distribution on the tractor can be achieved. The EBS connection must be active for the axle lift load to work.

Axle lifting feature is controlled automatically due to the legal regulations. When the speed limit exceeded while the EBS is active, some axles can be lifted automatically if the load on the axles is less than the maximum allowable axle load.

It may be necessary for the operator to manually intervene the axle lift with a departure help aid or maneuvering aid.



In order for the departure aid to be activated (raising the axle) , the vehicle must be slower than 30 km/h and the technical capacity of the axles must not exceed 30%.

When the vehicle is stationary, it is possible to activate the traction help by pressing the tractor brake pedal 3 times in a row.

If your vehicle have optional axle lifting feature from tractor cabin, it is possible to manually lower/ raise the axle lift with a spring loaded button to be installed in the tractor cabin. For this feature, your tractor must be adjusted according to the tractor.

It is also possible to activate /deactivate the axle lift with the help of the button on the trailer. Driving assistance can be activated by pressing and holding this button for less than 5 seconds. If it is pressed more than 5 seconds, the axle can be lowered to the ground.

You can also find information on how to use the axle lift control on the driving aid sticker on your vehicle.



As a result of intervention in the axle lift parameters, your vehicle may be out of regulation. For this reason, the EBS modulator should not be interfered with except authorized services.



Axle lifting device

- 1- ECAS Control box
- 2- Joystick
- 3- Axle lifting / lowering



Axle lifting



There is a danger of being pinched and injured when lowering /raising the axle.

3.7.3. Hubodometer

Hubodometers show the distance traveled by the vehicle in kilometers or miles.

The unit of the hubodometer is written on the hubodometer. It is adjusted according to the tire diameter.



Digital hubodometer



Analog hubodometer

3.8. Tires

When you are choosing tires, the first criteria are the load capacity index. Be sure that the load capacity index is suitable for your vehicle.

Tire manufacturers produce different types of tires according to the purposes of their use such as highway use, off-road or mixed-use. Please choose the correct type of tires according to the road conditions that you will use the vehicle. Choose the low decibel as soon as possible version. Tires as possible as having to Class A fuel efficiency level and braking on wet surfaces according to EU tire label stickers.



You can see the EU tire labels of the tires which were used in your vehicle on our website.

In dual/twin line wheeled vehicles, the tires must be matched properly according to their diameters. The tread depths on the adjacent tires shall not be different more than 5 mm. Furthermore, the newly coated tires and partially worn tires shall not be used side-by-side in relation to the structure and type of the vehicle. Otherwise, driving safety will be disrupted. In such tires, though the tread depths are seen, it must be deduced that the tire diameters are different and the tires exceeding the radius differences by 10 mm must not be used side-by-side.

Wrong matching will lead to excess shape deformation of the larger tire by carrying more load than necessary. In such a case, the wearing will accelerate and reveal the risk of early wearing of the tire. This case must be considered whenever radial and transverse layered tires are used side-by-side.



Tires



In some countries, seasonal use of M+S (Mud and Snow) or 3PMSF (3 Peak Snowflake) may be mandatory. In the country of driving, this etc. Tire regulations must be observed.



M+S and 3PMSF symbol



Very serious accidents can occur if unsuitable or worn tires are used.



Make sure that you put the necessary warning signs and take the safety precautions during the tire change.



Driving with insufficiently secured spare tire(s) can cause traffic accidents.



Since tires are heavy parts, pay attention to ergonomics and occupational health and safety rules during tire replacement. There is a risk of pinching, falling, and cutting.



For whatever tire the spare tire carrier is designed for, carry only that type of tire in the carrier. Follow the rules and regulations when removing/installing or maintaining the spare tire or regarding the spare tire carrier.

3.9. Spare Wheel Holder

Different type of spare wheel holders is optionally offered in our vehicles.

3.9.1. Crane Type Spare Wheel Holder

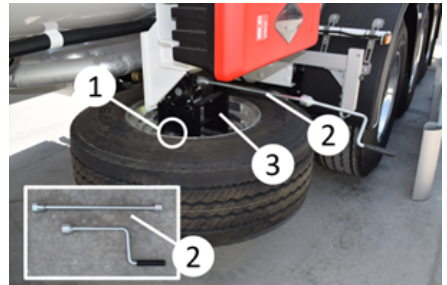

Crane Type Spare Wheel Holder

Removing the spare wheel:

- Remove the screws (2).
- Mount the lever (3) and turn it counterclockwise slowly. The spare wheel will be lowered.
- Remove the fixation parts (4) and take the spare wheel.

Placing the spare wheel:

- Mount the fixation parts (4) to the tire.

- Lift the tire upwards by turning the handwheel (3) clockwise.
- Turn the lever (3) clockwise and the tire will be lifted.
- Mount the screws (2) and fix the tire.
- Remove the lever (3) and store in the toolbox or cabinet.

3.10. Mudguards

Your vehicle has mudguards and mats in accordance with legal regulations. This equipment prevents water and similar substances on the ground from splashing onto other vehicles.

Some vehicles may have folding mats to prevent the mat from rubbing against the ground in the event of a crash.



Mudguards

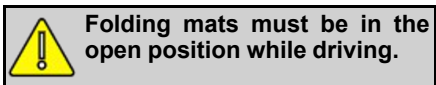

3.11. Mudguard with Sheet

The top of the rearmost mudguard can be covered with a sheet metal for reinforcement purposes.

3.12. Wheel Chock

There are two units wheel chocks and holders in the vehicle.

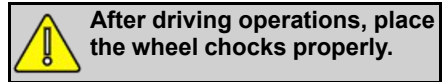
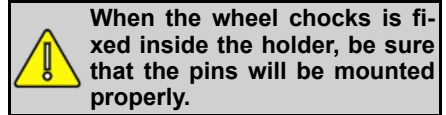
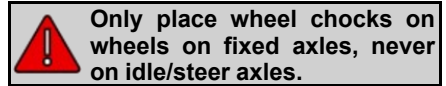
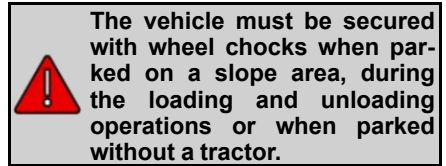

3.12.1. Pin Type Wheel Chock Holder

Removing the wheel chock from holders: Pull out the cotter pin (1) located at the end of the wheel chock holder. Then take the wheel chock from its slot by pulling it sideways from the wheel chock holder.

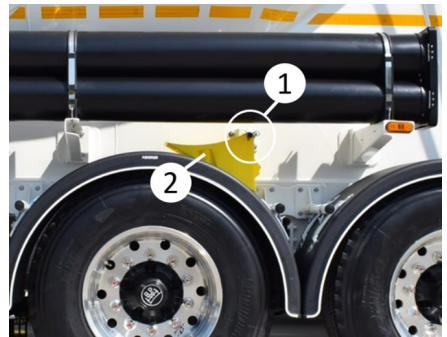

Pin type wheel choke holder

Placing the wheel chock from its holder: Place the wheel chocks on the holders and mount the cotter pin (1) to pin.

3.12.2. Pocket Type Wheel Chock Holder

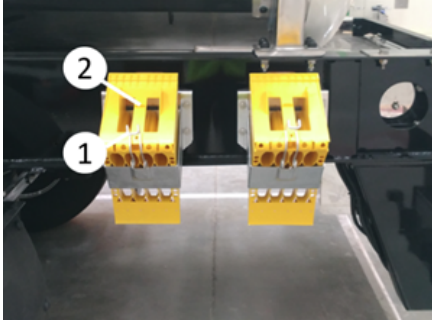



Pocket type wheel chock holder

Removing the wheel chock from holders: Remove the wheel chocks by pushing the handle (1) which is located at the end of the chock's holder from the wheel chock to the other side.

Placing the wheel chock from its holder: Insert the wheel chock by pulling the handle (1) which is located at the end of the wheel chock's holder.

3.13. Boxes and Storage Units

 After making sure that the cabinets and storage units are completely closed, the materials inside are fixed and safe, start driving. Falling parts can cause a traffic accident.

 Make sure that the necessary safety precautions are taken while using the cabinets and storage units.

3.13.1. Stainless Steel Toolbox

It is used to store tools and tools. It is usually mounted on the driver's side of the vehicle.

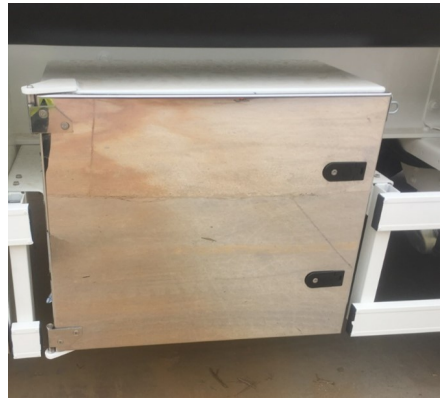

Toolbox



Opening the lock

Opening the lock:

- Insert the key into the lock and turn it to the unlocked position.
- Pull the lock lever back and open the cover by turning it.

3.13.2. Plastic Toolbox



Plastic toolbox



Plastic toolbox

Unlocking The Toolbox:

- Remove the lock cover.
- Unlock by turning the key.
- Pull the lever towards you.
- Turn the lever and open the cabinet door.

3.13.3. Aluminium Toolbox

It is a painted aluminum toolbox. It is used to store tools. The discharge elbow, plastic hammer, crescent wrench and the key for the hose carriers are supplied as standard in this box (1). It is mounted on the left side of the vehicle, just behind the landing gear, but its location may vary according to the construction of the vehicle.



Toolbox

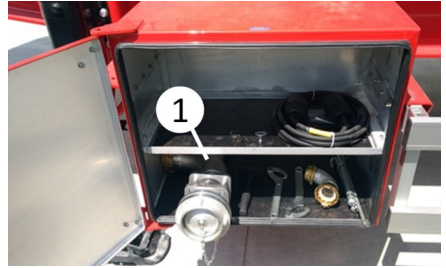

Toolbox



Opening the lock

Opening the lock:

- Insert the key into the lock and turn it to the unlocked position.
- Pull the lock lever back and open the cover by turning it.

3.13.4. Fire Extinguisher Cabinet

Fire extinguisher cabinets are used to protect fire extinguishers from the external environmental factors.



Fire extinguishers should be maintained regularly, and their expiration dates should be observed.



Fire extinguisher cabinet

Opening The Cover:

- Open the 2 plastic latches (1) which are holding the cover.
- Lift the latches up and back and open the cover.
- Remove the re-closable fasteners (black tape) in the fire extinguisher box and take the fire extinguisher.

Closing The Cover:

- Insert the fire extinguisher and fix it with re-closable fasteners (black tape).
- Close the cover first and after that put the latches to the top of the cover.
- Close the latches and lock the cover.

3.13.5. Water Tank

The vehicle may have a water tank for general cleaning purposes. You can turn the tap and open the water. You can fill the water tank with the help of the filling neck which is located at the top of the tank.

There may be a soap dispenser on the water tank. You can disassemble and fill the soap dispenser by turning it counterclockwise.



Please be careful about the hygienic rules and regulations. The wastewater must be disposed of in accordance with the regulations of the country that you will be in.



The water in the water tank should not be drunk. It should be only used for cleaning purposes.



In cold weather, the water tank should be emptied. Otherwise, the water tank may be cracked because of the freezing water.



Water tank

3.13.6. Hose Carriers

For the purpose of carrying the drain hoses, they are (1) mounted at both side of the vehicle, on upper part of the chassis. They can be present at various length and diameters. The hose carrier with back lid is shown in the picture, optionally the lid can be installed in front or at both sides.

The keys of the lid are provided in the tool box.

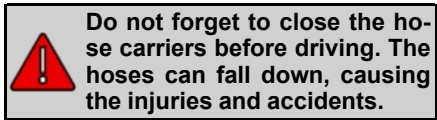

Hose carrier

3.13.7. Hydraulic Pump and Oil Tank

In the hydraulic pump system, there is an aluminum oil tank where the oil is stored, used for lifting the hydraulic cylinder, and a 24 V electro-hydraulic pump.

3.14. Working Lamp

It is placed at the rear part of the vehicle, mounted above bumper or on chassis profile. Its location could vary according to the vehicle's construction and customer's request. It is placed at the rear of the vehicle, to be used in operations after it gets dark. In order that the lamp can be used more comfortably and in a larger area, its arms can be folded and extended. To prevent it to swing away, it is fixed with a latch-lock mechanism. The lamp is turn on and off by means of the switch (2) found on chassis or inside the toolbox.



Working lamp

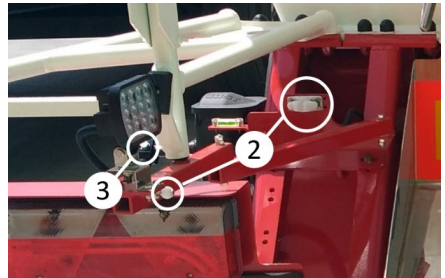

Latch-lock mechanism and switch

Activating the lamp:

By pulling the lamp release the upper arm from the latchlock mechanism, then use it by pulling it where you need it.

Securing the lamp:

After using, fold the folding arms and push the lamp into its place. By locking the latch-lock mechanism, secure the lamp.



Before releasing the lamp, do not forget to fold the night parking plate (if equipped) upward (close).



Do not drive the vehicle unless you correctly secure the working lamp with latch-lock mechanism. Otherwise, while driving, the lamp could swing away and cause injuries.

Optionally, the working lamp switch (3) can also be supplied behind the working lamp.



Working lamp switch

3.15. Ladder and Walkway

Stairs that allow us to reach some parts more easily in the vehicle are optionally available.



There are serious hazards when driving on unsecured ladders. While driving, the ladder can be thrown and this can injure people.



Slips from the stairs can cause an accident. Ladders that have been polished, cleaned or wet should be handled very carefully. Never use unsuitable methods and devices to climb over or getting down from the semi-trailer. Do not jump from the semi-trailer.

There are two types of ladders in the vehicle.

- Foldable Ladder

- Fixed Front Ladder

3.15.1. Foldable Ladder

The lower part of the ladder (1) which is used for climbing on the tank is manufactured to be folded for easiness and safety. To comply with the UVV directives and depending on the customer's request, the folding ladder is attached to the handrail. Thus, when the ladder is opened the handrail is opened too.



Foldable ladder

Opening the foldable ladder:

Hold the grab (1) on the ladder and release it from the latch-lock mechanism (2) by pulling toward yourself. Open the released ladder by pushing downward (Optionally pneumatic controlled).

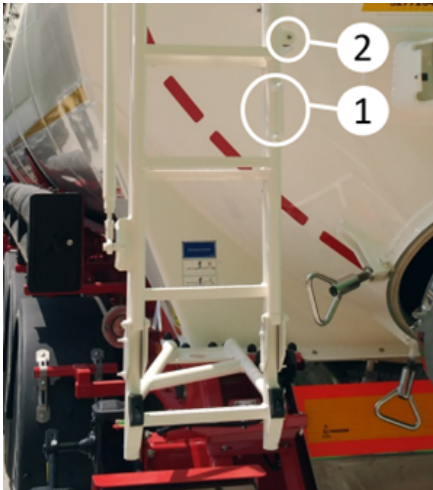

Foldable ladder

Closing the foldable ladder:

By holding at the lower part of the ladder, lift it upward slowly to prevent the handrail drop suddenly. By locking the latch-lock mechanism, which is mounted on the fix part of the ladder, secure the ladder.



Since the handrail is raised while the ladder is opened, don't release the ladder unless you open it completely. Otherwise the handrail cannot be raised entirely and it can drop on the silo tank, thus it causes damage to both itself, to the silo tank and to the ladder.

3.15.2. Fixed Front Ladder

The ladder used to climb to the top of the vehicle is manufactured for easiness and safety. In terms of compliance with UVV rules and depending on the customer's request, the front ladder is connected to the upper walkway. In this way, access to the vehicle is provided via a fixed ladder.

3.15.3. Walkway

To walk on the silo vehicle comfortably, there is a walkway (1) on the left top side

of the silo vehicle. Use this walkway when you climb on the vehicle to access manhole cover, filling neck and top air coupling or to perform maintenance and cleaning operations.

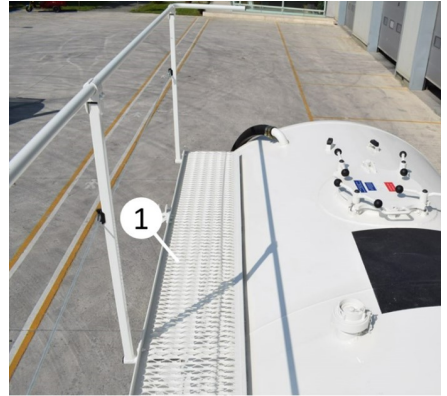

Walkway

The walkway has been manufactured as rough to prevent slipping. The walkway is changed according to the vehicle type.



Foreign materials and objects placed on the walkway can cause you to slip, stumble or even fall and thus you could injure yourself.

- Never place anything on the walkway.
- Clean the walkway regularly to prevent it from getting slippery and in particular, keep it free of snow ice in winter.



If the handrail is not raised, you can fall from the silo tank and be seriously injured. Always raise the handrail before you get onto the silo tank.

3.15.4. Rope

A rope is installed on the handrail. It is mounted to prevent the person who works on the silo tank to fall down.

3.16. Rear Bumper (Rear Protection Equipment)

Your vehicle has a rear bumper (rear protection equipment) in accordance with legal regulations.



If you drive with a damaged bumper, traffic safety is to be compromised. And if anyone hits your vehicle from the rear side, the size of the accident will be bigger. That's why, the damaged bumper must be replaced with the original one quickly.

3.16.1. Fixed Bumper Silo vehicle bumper

1. Lamp group
2. License plate location
3. License plate lighting
4. Side marker lamps
5. Reflectors

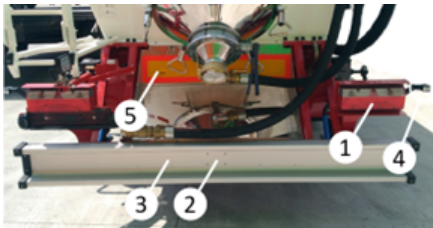

Bumper

3.17. Night Park Plate

To warn the other vehicles, an optional plate is mounted at the left rear side of the vehicle.



Night park plate

Opening the plate:

By turning the latch (1) clockwise or counter clockwise 90°, open the plate which is closed downward.

3.18. Sliding Sheet Metal

It is mounted under bottom part of the rear discharge cone to pour the materials that fall down on it to the ground.

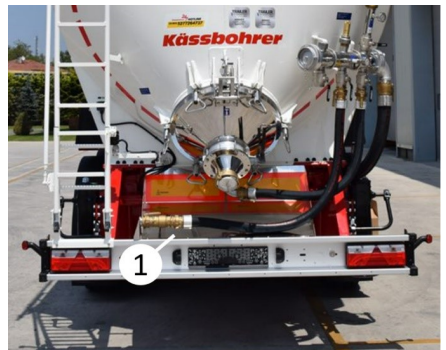

Sliding sheet metal

4. UPPERSTRUCTURE COMPONENTS AND USE

In this section, we will talk about the components on the silo vehicle and their uses and purposes. It is extremely important to fully understand how these components are used and their intended use so that loading and unloading can be carried out in a healthy and safe manner. Therefore, before proceeding with the loading and unloading processes, read this section carefully and pay attention to the warnings.

4.1. Tipping Silo (SSK)



Tipping silo

The silobas vehicle is completely made of aluminum.

The chapter will begin with an overview of the equipment on tipping silo vehicle and then continue with the detailing of the uses of these elements. Afterwards, an overview of the equipment on the non-tipping silo and the details of the uses of these elements will be explained.

4.1.1. Overview to the Superstructure Components on Tipping Silo

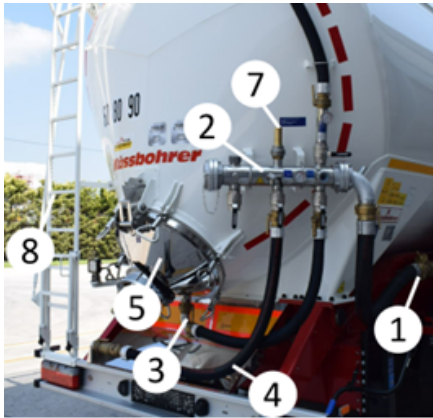

Superstructure components

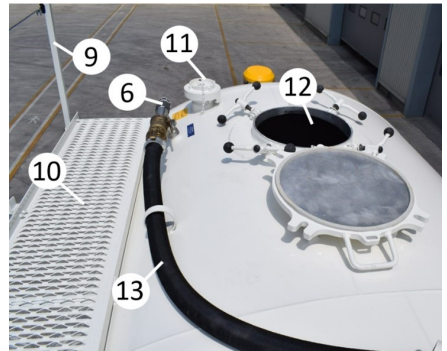

Superstructure components

| No | Component | Function |
|----|-----------------------|---------------------------------------------------------------------------------------|
| 1 | Side air line | It directs the air supply from the compressor to the air battery, then to the system. |
| 2 | Air mixture battery | It is used to control the air flow while the silo vehicle is unloading. |
| 3 | Fluidisation air line | It mixes the materials in the tank so that they are unloaded more easily. |
| 4 | Jet air line | It blows the material on the end of the discharge cone for quick discharge. |
| 5 | Discharge Cone | It ensures the material to be discharged by raising the tank. |
| 6 | Vacuum valve | It prevents the formation of negative pressure inside the silo tank. |
| 7 | Pressure safety valve | It prevents excessive pressure inside the silo tank |
| 8 | Ladder | It is used to climb on the silo tank |
| 9 | Handrails | It is used to walk on the walkway safely |

| | | |
|----|--------------|-----------------------------------------------------------------------------|
| 10 | Walkway | It is used to walk on the silo tank comfortably |
| 11 | Filling neck | It is used to load the silo tank with closed circuit or clean the silo tank |
| 12 | Manhole | It is used to load or clean the silo tank |
| 13 | Top air line | It directs the air to the top of the silo tank |

4.1.2. Loading / Discharging System

4.1.2.1. Air Mixture Battery

The air mixture battery is mounted at rear right side of the silo tank. It controls flow of the air, which is used while the vehicle is discharging, by means of fluidiser air (3), jet air (4) and top air lines (5) located on it. This enables you to discharge the material from the tank and control the inside pressure of the silo tank.

Use the side air line (2) to connect the air mixture battery to the compressor that is equipped on the vehicle or that is external. There is a check valve on the side air line to prevent the pressurized air return back, causing a compressor failure.

Also the safety valve (6) which limits the operating pressure in the silo tank is mounted on the air mixture battery.

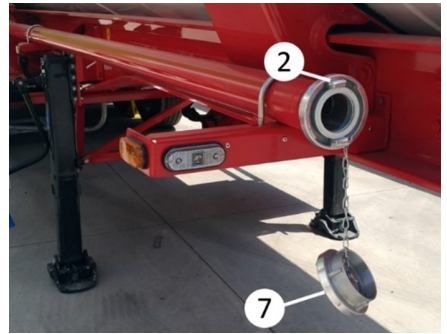

Side air line inlet

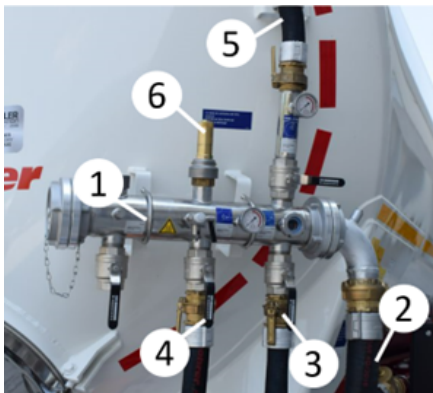

Air mixture battery



Connect the compressed air to the air line only if you are going to use (2). Close the connection with the cap (7) when you do not use.



Components transferring compressed air can reach high temperatures when in operation and can cause burns if touched. Do not forget to wear protective gloves when you pressurize the connections.



If you open blind covers or couplings on the air battery of a silo tank that is under pressure, there is a risk that it will open explosively. If this happens, you or others could be seriously injured. Therefore, check whether the system is under pressure before opening blind cover or couplings, vent the air battery or the silo tank completely.

4.1.2.2. Side Air Line

It is the air line that supplies air for the system by connecting to the compressor that is equipped on the vehicle or that is external. The portion of it which is connected to the either compressor or air battery is made of flexible hose for easiness of use. A check valve is equipped on the side air line to prevent the air to enter to the compressor and a cause a failure by returning back.

4.1.2.2.1. Air Compressor

Compressors are typically piston-type or screw-type compressors operating with air.

Operating System

Air Intake: The cement air compressor uses an intake valve to draw in outside air. The air is pulled into the compressor.

Compression: The intake air is compressed using a piston or screw rotors. In piston compressors, the piston pushes

the air into the cylinder, reducing the volume inside the cylinder and compressing the air. In screw compressors, the rotation of the screws compresses the air.

Storage of Compressed Air: The compressed air is directed to a storage tank or another air reservoir, where it is stored under pressure.

Distribution to Application Points: The compressor supplies the compressed air into the side air line to generate the pressure required for the cement unloading process. Through the air line, the pressurized air fills the tank, creates internal pressure, and pushes the material inside the silo toward the discharge system.



Air Compressor

4.1.2.3. Fluidiser Air Line

The fluidiser air line mixes the products with the air to prevent the product being accumulated at the hole of the discharge cone by releasing the accumulated product during unloading, thus the product discharges much more freely and easily. The fluidiser air also inhibits clogging at the hole of the discharge cone. For this reason, connect the fluidiser air line to its location on the discharge cone during unloading operation.



Fluidiser air line

4.1.2.4. Fluidiser Air Line Valve

The fluidiser air line stop valve is located on the air battery and it controls the air which passes into the fluidiser air line. The position of the lever (2) which is seen in the picture is the open position. To stop the compressed air which passes to the line, you can bring the lever to the closed position by turning 90 degrees counter clockwise.



Fluidiser air line and valve

4.1.2.5. Jet Air Line

Jet air line (1) supports the material to discharge from the discharge hole. To be able to use the jet air, the discharge cone which is supplied with the vehicle has to be connected to the discharging cone. One end of the jet air is connected to the air battery, during unloading connect the other end of the line to its place (2) on the discharge cone. The material which is mixed and sent to the discharge cone by fluidizer air, discharges quickly by the help of the jet air.



Jet hava hattı

4.1.2.5.1. Jet Air Line Valve

The jet air line stop valve is located on the air battery and it controls the air which passes into the jet air line. The position of the lever (3) which is seen in the picture is the open position. To stop the compressed air which passes to the line, you can bring the lever to the closed position by turning 90 degrees counter clockwise.

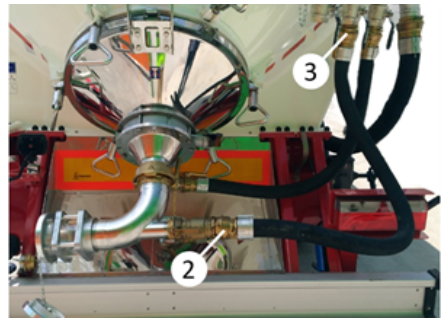

Jet air line valve

4.1.2.6. Top Air Line

The air which comes to the air battery passing through the side air line, is sent to the top of the vehicle by means of the top air line (1). The top air line enters into the silo tank from the top of the silo vehicle. The entering point of the air line could vary according to the construction of the vehicle. The air, which enters into the silo tank via the top air line, with an operating pressure of 2 bar, both keeps the inside of the silo tank under the pressure and mixes the inside of the silo tank to make the products to be discharged completely and easily.

4.1.2.6.1. Top Air Line Valve

Top air line stop valve controls the air which enters into the silo tank. If it is turned off no air could enter into the silo tank from the top. The position of the lever which is seen in the picture is the open position. To stop the compressed air, you can bring the lever to the closed position by turning 90 degrees counter clockwise.



Top air line

4.1.2.7. Thermometer

Thermometer (1) shows the temperature of the air that is sent to the system. The temperature of the air that is sent to the system is very important for the materials which are sensitive to heat. If the temperature is very high, it should be cooled down to the acceptable level.

4.1.2.8. Manometers

Manometers (2) show the pressure of the air in the air line. Two of them are located on the air battery and also there are also manometers on the air line. Since the operating pressure of the silo tank is 2 bar, it is important to watch the pressure while there is pressure in the system. The required countermeasures must be taken immediately when the pressure is raised or lowered.

 The number and location of the manometer could change according to the vehicle type.

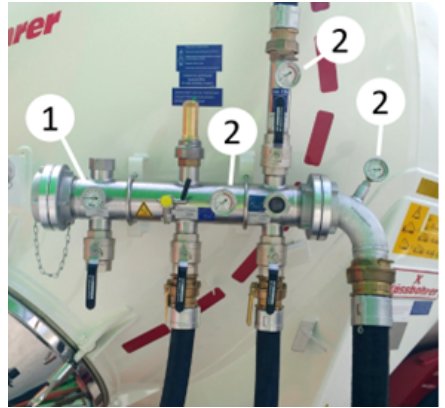

Thermometer and manometers

4.1.2.9. Vacuum Valve

The vacuum valve (1) is an important protective device. It prevents a negative pressure in the silo tank due to the changes in the air pressure and temperature. Thus it protects the silo tank from being damaged by compression. Vacuum valve is mounted on the top air line or on the air battery.

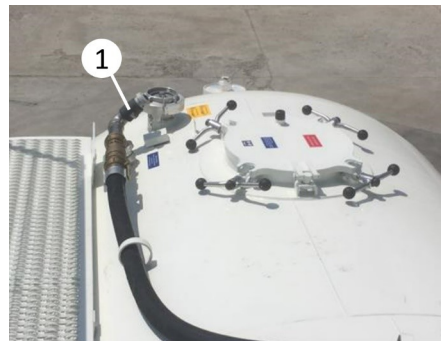

Vacuum valve

 Clean the vacuum valve daily and check the operability

4.1.2.10. Pressure Safety Valve

The safety valve (1) is an important protective device. It limits the pressure in

the silo tank (operating pressure) to max 2 bar, thus preventing the tank being exposed to excessive pressure. The safety valve is mounted on the air battery placed at the rear side of the vehicle. The system pressure can be seen from the manometer which is right at the inlet of the valve.

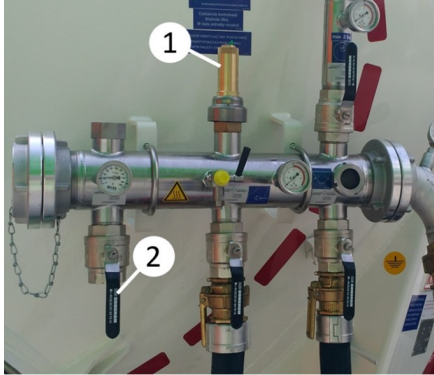

Pressure safety valve and ventilation valve

4.1.2.11. Ventilation Valve

It is used to ventilate the silo vehicle. Close the ventilation valve when the silo vehicle is required to be unloaded with compressed air.

 In normal status the ventilation valve must be “open”, while pressurized discharging is performed the ventilation valve should be “closed”.

 If the material is inhaled or comes into contact with skin or eyes during venting, it can cause injuries such as chemical irritation, burns and poisoning. Avoid physical contact with the load. Avoid inhaling any dust that may escape. Wear protective clothing that is appropriate to the load. If the load causes an injury, consult the material’s safety action sheet for the remedial action that needs to be taken.

4.1.2.12. Manhole and Manhole Covers

Manholes are used to load the vehicle from the top. The vehicle can be loaded from the top by opening the manhole cover after the vehicle comes into the facility.

Opening covers:

- There are four hatch clamps (1) on the manhole cover, loosen the clamps by turning counter clockwise.
- After all four clamps are loosened, tilt the clamps from top of the lid to the top of the silo tank.
- By holding the free hatch from the bar (2) on the lid, tilt it on the rubber mount (3) placed on the cover.

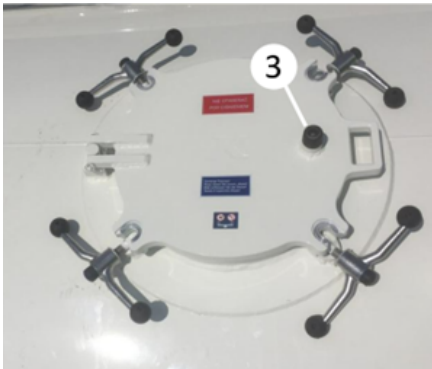
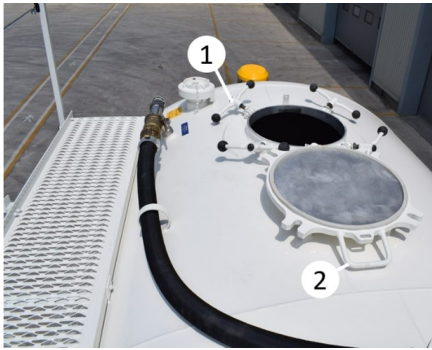

Manhole and Manhole Covers

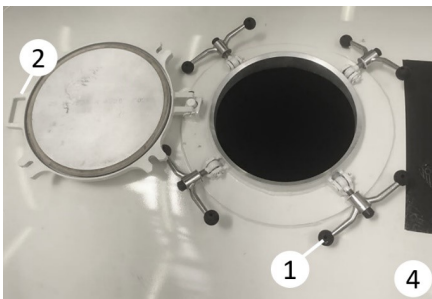

Manhole cover

 When loosening or tightening the clamps of a manlid that is under pressure, the manlid can tear away explosively from the silo tank and injure you or other people. Never loosen or tighten the clamps of a manlid when the silo vehicle is under pressure.

 If the thread of a hatch clamp is damaged, manlid can tear away explosively from the silo tank and injure you or others.

- The silo vehicle should never be placed under pressure even if only one thread is damaged.
- Always only hand tighten the hatch clamp crosswise.
- Replace damaged threads immediately.

 The damaged thread of a hatch clamp cannot withstand the tank's internal pressure and tears off.

Follow these rules when closing or opening a manlid:

- Check that the sealing surfaces on the manhole and manlid are clean and undamaged before closing.
- After closing the manlid, tighten the clamps crosswise evenly and tighten with hand only.
- Do not tighten the hatch clamps with your foot, with a pipe, a hammer or any other tool.
- Never re-tighten or loosen the clamps of a manlid when the silo tank is under pressure.
- Grease the thread of the hatch clamp regularly.

4.1.2.13. Discharge Cone

The discharge cone is located at the rear of the silo tank. The discharge cone can be used for:

- Entering into the silo tank in order to inspect or clean it.
- Checking whether the fluidiser air line is clean.
- Replacing the fluidiser air element.

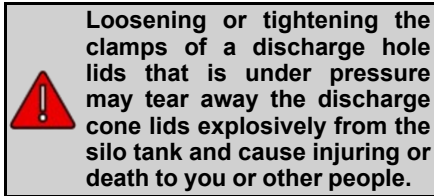

Discharge cone

Components of the discharge cone:

1. Discharge cone
2. On-off valve on the material coupling
3. Fluidiser air coupling
4. Blind cover
5. Reduction adapter of material discharging
6. Eyelet screw of the discharge cone
7. Pivot arm (retaining arm of the discharge cone)

The discharge cone is kept closed using cone fasteners (nuts). The discharge cone's lid bears up against a test pressure of 3 bar and it is fully sealed.

The material coupling is used to empty the silo tank. To make the discharging procedure easier, the material is mixed with fluidizer air causing much more easy discharging. The fluidisation air is supplied into the cone from the connection which is placed under the discharge cone.

Opening the lid:

- Loosen the cone fasteners of the discharge cone.
- After you loosen all the fasteners, release the lid by sliding the fastener to the side.
- To be able to keep the fasteners fixed, get the washer on the fasteners to the position as seen in the small picture.
- After you release the lid, pull it upward.
- Lock the raised lid with the spring-lock mechanism (7) placed on the top.

Closing the lid:

- Gently lift the lid which is secured with the spring-lock mechanism on top by holding at its lower part.
- The spring-lock mechanism will be re-leased automatically.
- Lower the released lid downward (carefully).
- Close the lowered lid by securing it with cone fasteners.

 The discharge cone can vary according to the vehicle type.



Discharge cone

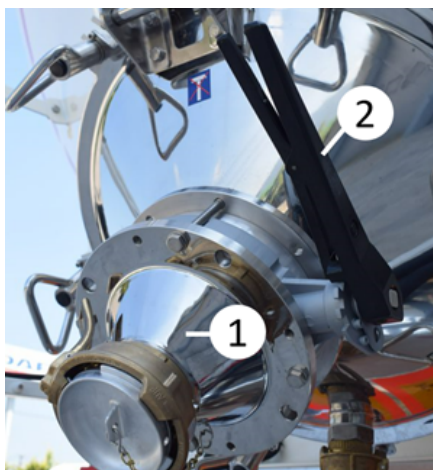

Material discharging reduction connection



Spring-lock mechanism

4.1.2.14. Reduction Adapter of Material Discharging

The adapter of the material discharging is located at end of the discharge cone (1) and used to connect the coupling on the outlet of the silo vehicle's discharge cone. The discharge cone is controlled by the open-close valve (2) on the adapter of material discharging.

 Opening or loosening a hose coupling during the emptying procedure will cause the product to spray around and the material hose could whip back and forth. The whipping hose could cause injuries.

 Always use the blind cover to close the hose coupling after use. It acts as an additional shut-off element to avoid product loss.

4.1.2.15. On Off Butterfly Valve Located on Material Discharge Connection

This valve is used to open or close the connection of material discharging. The locking arm (1) prevents unwanted, inadvertent shifting in the butterfly valve arm (2).



Butterfly valve

To move the valve with the arm of the butterfly valve, firstly the lock arm should be released. After the valve is adjusted and the arm of the butterfly valve is released, the lock arm is relocked. When the discharge begins, the valve must be put into fully open position, discharging when the valve is not fully opened causes valve gasket to wear.

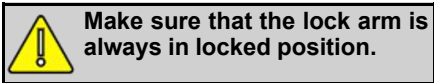

4.1.2.16. Hydraulic Cylinder of the Silo Vehicle

To realize the unloading operation, the silo vehicle is raised. For this purpose, there is a hydraulic controlled cylinder (1), which is mounted to the chassis, in front of the vehicle.

The raising and lowering of the cylinder is performed via the control panel which is located just behind the right rear wheel. Hydraulic cylinder (1) bearings and roll over shaft (2) bearings should be greased regularly.



Hydraulic cylinder



Roll over shaft



Greaser label



Butterfly valve

3- Locking arm

4- Butterfly valve arm

Raising the piston:

Raise the arm (5) on the control panel.



Control panel

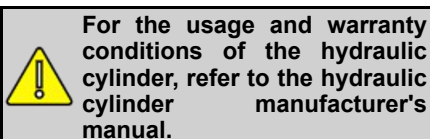
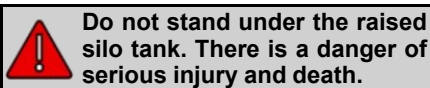
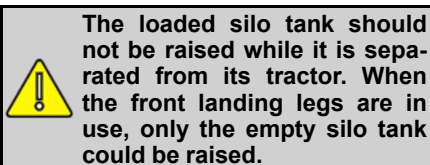
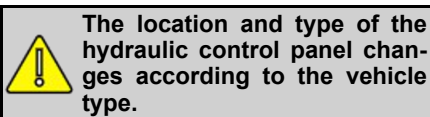

Lowering the piston:

After discharging operation lower the piston by lowering the arm.

4.1.2.17. Walkway

To walk on the silo vehicle comfortably, there is a walkway (1) on the left top side of the silo vehicle. Use this walkway when you climb on the vehicle to access manhole cover, filling neck and top air coupling or to perform maintenance and cleaning operations.

The walkway has been manufactured as rough to prevent slipping. The walkway is changed according to the vehicle type.

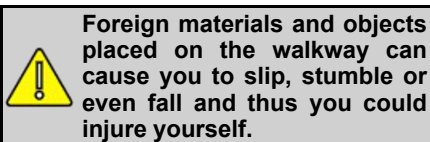

- Never place anything on the walkway.
- Clean the walkway regularly to prevent it from getting slippery and in particular, keep it free of snow ice in winter.



If the handrail is not raised, you can fall from the silo tank and be seriously injured. Always raise the handrail before you get onto the silo tank.

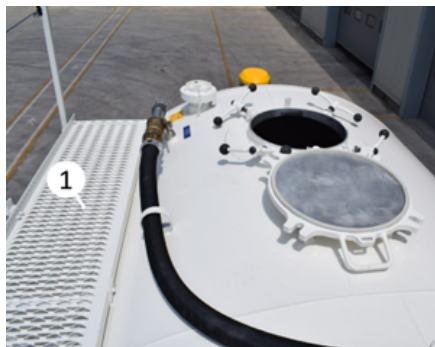

Walkway

4.1.2.18. Filling Neck

It is used to load the silo tank with closed circuit or clean the silo tank.

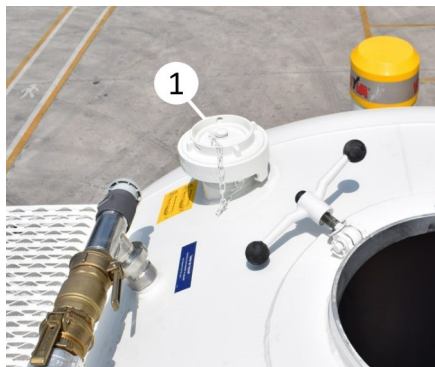

Filling neck

Opening the filling neck (1) connection:

Open the ball valve with the lever. If air is given out, close the valve and immediately discharge all the air inside the silo tank by using the air discharge valve.

Open the blind cover by using the yoke wrench.

Turn the blind cover counter clock wise until the end and remove.

You can make filling or cleaning by fastening the hose onto the filling neck that is opened.

Closing the filling neck connection:

Follow the above procedures in reverse order to close the filling neck.



When opening the loading coupling of a silo tank that is under pressure, there is a danger that the blind cover will be blown off explosively, despite all the constructional safety measures. If this happens you or others could be seriously or even fatally, injured.

4.1.2.19. Vibrator

Due to their consistency, certain types of material can compact during long journeys and stick to the silo tank's walls. It is hard to unload these type of materials when the silo tank is raised.

Vibrator is an pneumatic device. It shakes the silo tank for a short time, these vibrations free the material from the silo tank's walls so that it can be discharged. This is an optional specification.

4.1.2.19.1. Vibrator Bracket

These are the housings on which the vibrator is mounted. There are two vibrator housings, one of them is on the front dome and the other one is just in front of the roll over bearing.



If the vibrator is used for too long, it can damage the welded seams of the silo tank. Only use the vibrator for short periods of time.

4.1.2.20. Compressor

The required air when the silo tank is unloaded can be supplied externally, but also it can be supplied from the compressor which is generally mounted in front of the vehicle according to the customer's demand.

See the manufacturer's user's manual for operating instructions of compressor and for more detailed information.

4.1.2.21. Discharge Elbow

The discharge elbow (1) is attached to the material coupling when compressed air will be used for emptying. The discharge elbow has a coupling (2) for jet air that enables the vehicle to be emptied with compressed air.

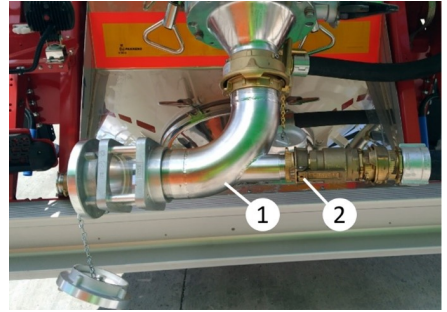

Discharge elbow

4.2. Non-Tipping Silo (SSL)



Non-Tipping Silo (SSL)

4.2.1. Overview to the Superstructure Components on Non-Tipping Silo

1. Side air line
2. Manometer
3. Top air line valve
4. Manometer
5. Ventilation valve (Air discharge valve)
6. Pressure relief valve
7. Jet air (1st cone)
8. Fluidiser air (1st cone)
9. Jet air (2nd cone)
10. Fluidiser air (2nd cone)



Side air line

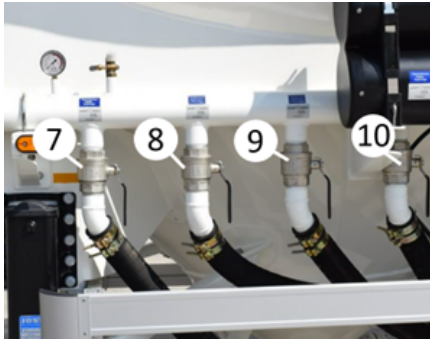

Collector

4.2.2. Loading / Discharging System

4.2.2.1. Side Air Line

It is the air line that supplies air for the system by connecting to the compressor that is equipped on the vehicle or that is external. A check valve is equipped on the side air line to prevent the air to enter to the compressor and cause a failure by returning back.

4.2.2.2. Manometers

They show the pressure of the air in the air line. There are manometers (1) on the air line. Since the operating pressure of the silo tank is 2 bar, it is important to watch the pressure while there is pressure in the system. The required countermeasures must be taken immediately when the pressure is raised or lowered.

 The number and location of the manometer could change according to the vehicle type.



Thermometer and manometers

4.2.2.3. Fluidiser Air Line

The fluidiser air line mixes the products with the air to prevent the product being accumulated at the hole of the discharge cone by releasing the accumulated product during unloading, thus the product discharges much more freely and easily. The fluidiser air also inhibits clogging at the hole of the discharge cone. For this reason, connect the fluidiser air line to its location on the discharge cone during unloading operation.

4.2.2.4. Fluidiser Air Line Valve

The fluidiser air line stop valve is located on the air battery and it controls the air which passes into the fluidiser air line. The position of the lever (2) which is seen in the picture is the open position. To stop the compressed air which passes to the line, you can bring the lever to the closed position by turning 90 degrees counter clockwise.

4.2.2.5. Jet Air Line

Jet air line (1) supports the material to discharge from the discharge hole. To be able to use the jet air, the discharge cone which is supplied with the vehicle has to be connected to the discharging cone. One end of the jet air is connected to the air battery, during unloading connect the other end of the line to its place (2) on the discharge cone. The material which is mixed and sent to the discharge cone

by fluidizer air, discharges quickly by the help of the jet air.

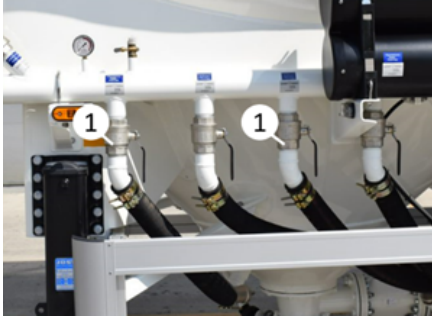

Jet air line

4.2.2.6. Jet Air Line Valve

The jet air line stop valve is located on the air battery and it controls the air which passes into the jet air line. The position of the lever (3) which is seen in the picture is the open position. To stop the compressed air which passes to the line, you can bring the lever to the closed position by turning 90 degrees counter clockwise.

4.2.2.7. Pressure Relief Valve

The safety valve is an important protective device. It limits the pressure in the silo tank (operating pressure) to max 2 bar, thus preventing the tank being exposed to excessive pressure. The safety valve is mounted on the side air line. The system pressure can be read from the manometer (2) which is right at the inlet of the valve. Safety valve must be cleaned periodically.

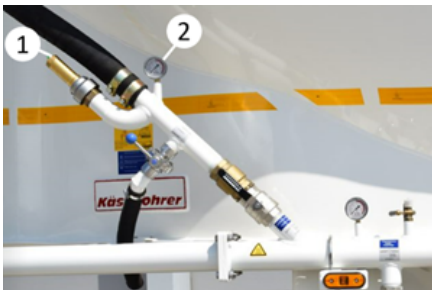

Pressure relief valve and manometer

4.2.2.8. Ventilation Valve (Air Discharge Valve)



Air discharge valve

It is used to ventilate the silo vehicle. Turn off the ventilation valve when the silo vehicle is required to be discharged with compressed air.

 In normal status the ventilation valve must be “open”, while pressurized unloading is performed the ventilation valve is “closed”.

 If the material is inhaled or comes into contact with skin or eyes during venting, it can cause injuries such as chemical irritation, burns and poisoning.

 Avoid physical contact with the load. Avoid inhaling any dust that may escape. Wear protective clothing according to the load. If the load causes an injury, consult the material’s safety data sheet for the remedial action that needs to be taken.

4.2.2.9. Menhol ve Menhol Kapakları

Manholes are used to load the vehicle from the top. The vehicle can be loaded from the top by opening the manhole cover after the vehicle comes into the facility.

Opening covers:

- There are four hatch clamps (1) on the manhole cover, loosen the

clamps by turning counter clockwise.

- After all four clamps are loosened, tilt the clamps from top of the lid to the top of the silo tank.
- By holding the free hatch from the bar (2) on the lid, tilt it on the rubber mount (3) placed on the cover.

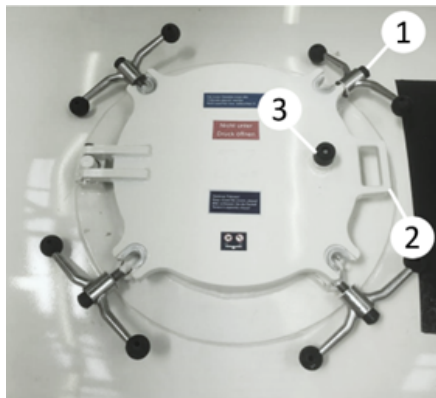

Manhole cover



Follow these rules when closing or opening a manlid:

- Check that the sealing surfaces on the manhole and manlid are clean and undamaged before closing.
- After closing the manlid, tighten the clamps crosswise evenly and tighten with hand only.
- Do not tighten the hatch clamps with your foot, with a pipe, a hammer or any other tool.
- Never re-tighten or loosen the clamps of a manlid when the silo tank is under pressure.
- Grease the thread of the hatch clamp regularly.

4.2.2.9.1. Gaskets

Gaskets and similar consumable materials may wear out and require replacement at different intervals depending on operational frequency, loading– unloading intensity, cleaning procedures, and operating conditions. Therefore, it is strongly recommended that these components be inspected regularly and replaced when necessary.

4.2.2.10. Discharge Cone

The discharging cones on horizontal silo vehicles (SSL) are placed as facing downward. Unlike SSK vehicles, these cones do not have a cover, emptying operation is done by means of fluidiser air, jet air and compression valves from the discharging hole which is installed optionally.

In picture, the jet air (1) is seen on the left, the fluidiser air (2) is seen on the right side.

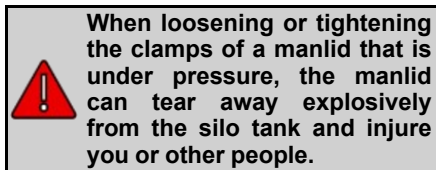

- Never loosen or tighten the clamps of a manlid when the silo vehicle is under pressure.

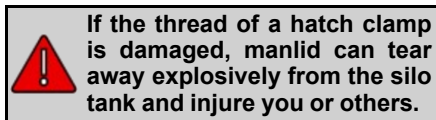

- The silo vehicle should never be placed under pressure even if only one thread is damaged.
- Always only hand tighten the hatch clamp crosswise.
- Replace damaged threads immediately.

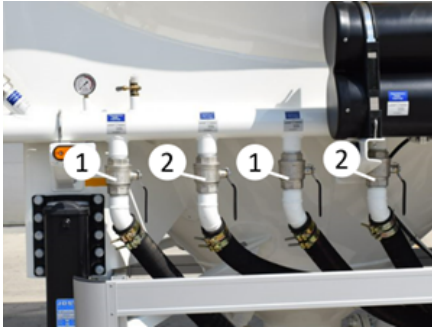

Jet air and fluidiser air connections

4.2.2.11. Butterfly Valve

It is used when the material is emptied on the ground with gravity. This valve is normally blinded, if it is provided optionally. Open the valve by turning the lever (1) which is seen in the picture and empty the material on the ground.



When gravity discharge is made (with gravity, without giving air into the tank), one of the manhole cover must be opened before starting the discharge. Check whether there is pressure inside the tank.



Butterfly valve

4.2.2.12. Pinch Valve

It is located at the outlet of the discharging cone, just before the jet air coupling. The pinch valve (1), which is closed while the material is transporting, is opened when the material is emptied.

Opening the valve:

The pinch valves are opened and closed pneumatically. The control levers of the

pinch valves are located either in the rear tool box with lock mechanism or at the side of the vehicle according to the vehicle's construction. To open the valves pull the button towards yourself, when the button is pushed, the valve is closed, when the button is pulled, the valve is open.



Perform a functional check of the brass valve once every three months. The functional check may be carried out at different/shorter intervals depending on the operating conditions.



Pinch valve



Location of buttons

4.2.2.13. Discharge Types on SSL Vehicles

On SSL Vehicles discharging cones can be offered to the customers in 3 different variations. These variations can change according to the vehicle's construction and the customers' demands.

Variations:

Discharging from rear:

The discharging lines of the front and rear cones become one line by combining and they discharge at the rear part of the vehicle.

Discharging from side:

The emptying lines of the front and rear cones combine and discharge at the side of the vehicle.

Separately discharging:

The discharging line of each cone discharges at the side of the vehicle individually.

 On SSL horizontal silo vehicles there can be three compressor couplings at the front, side and rear to enable easier operation.



Side air line connection

4.2.2.14. Opening the Filling Neck Connection

Open the ball valve with the lever. If air is given out, close the valve and immediately discharge all the air inside the silo vehicle by using the air discharge valve.

Open the blind cover by using the yoke wrench.

Turn the blind cover counter clock wise until the end and remove.

You can make filling or cleaning by fastening the hose onto the filling neck (1) that is opened.



Filling neck

4.2.2.15. Closing the Filling Neck Connection

Follow the above procedures in reverse order to close the filling neck.

4.2.2.16. Discharge Line Observation Glass

Optionally, an observation glass (1) can be fitted on the end section of the discharge line to check whether the material is discharged.

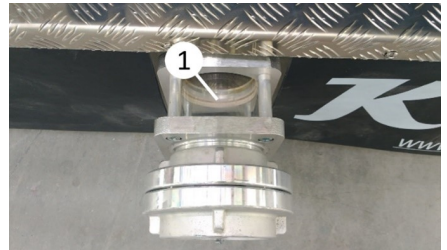

Discharge line observation glass

4.2.2.17. Compressor

The required air when the silo tank is unloaded can be supplied externally, but also it can be supplied from the compressor which is generally mounted in front of the vehicle according to the customer's demand.

See the manufacturer's user's manual for operating instructions of compressor and for more detailed information.

5. TRANSPORTATION PROCESS

5.1. Pre-Driving Checks

- Make sure that all necessary documentation is available at the vehicle,
- Make sure all necessary adjustments and loading condition are properly made,
- The vehicle is coupled and secured with the tractor properly and safely,
- Make sure that all pneumatic and electrical connections between the tractor and the vehicle are properly made and that the EBS system is operational,
- All structural hardware (wheel chocks, side underrun guards, ladder and etc.) are in their place and locked or secured properly,
- The load is distributed evenly to prevent any displacement during driving,
- The weight of the load is within the permissible limits,
- Comply with the regulations of the country you are in,
- Make sure that the lighting and signal system is fully operational,
- The tire air pressures are at the required level,
- The parking brake of the semi-trailer is released,
- All valves and manhole covers are closed and secured,
- The material hoses are safely removed.

5.2. Semi-Trailer and Tractor Coupling

Apply the following steps to couple the semi-trailer with the tractor:

- Check that kingpin and its couplings are normal. Make sure that there is an adequate amount of grease oil on the fifth wheel, top-connection plate and kingpin that will ensure undamaged coupling and not contain any dust and contaminant.
- Lower the height of the rear suspension airbags of the tractor until it can be inserted in the king pin section of the semi-trailer.
- Set the 5th wheel locking system on the tractor to the "On" position.
- Adjust the height of the semi-trailer to insert it into the tractor. The height of the semi-trailer can be adjusted with the mechanical landing gear. Prevent the movement of the semi-trailer by using the parking brake. Put wheel chock at the rear of the wheels for safety.
- Move the tractor, fifth wheel until it touches the top-connection plate of the semi-trailer and moves backwards slowly on the same level. The fifth wheel will slide smoothly under the top-connection plate and enter the kingpin's shoes and lock automatically with the intensity of impact.
- Raise the landing legs of the semi-trailer and insert the landing legs arm to its place.
- Connect the air, electrical and EBS cable and hoses to their places on the tractor. Be sure that all the functions are working properly.
- If the vehicle has a parking brake, release the parking brake.



If your vehicle is driven at the wrong 5th wheel height, malfunctions may occur in the vehicle. You may have height problems. The vehicle must be driven at the correct fifth wheel height.

Apply the following steps to uncouple the semi-trailer with the tractor:

- If the vehicle is equipped with service type brake chambers, apply the parking brake after checking the brake drum. Never apply the parking brake when the brake drums are very hot. (The drum may crack.)
- If the vehicle has a hand-brake type brake, put a wheel chock in front of the vehicle. Apply the handbrake.
- Disconnect the brake air lines, the brake will be applied automatically. Disconnect the semi-trailer electrical connections.
- Lower the mechanical landing gear of semi-trailer (use high speed). When the mechanical landing gear foots or wheels touch the ground, switch the mechanical landing gear crank handle to low-speed position to raise the semi-trailer.
- Unlock the fifth wheel lock. Separate the tractor from the semi-trailer about 500 mm by slowly moving the tractor forward. Lower the level of the rear suspension airbags of the tractor and leave the semi-trailer's bottom.



To ensure that that the king pin is locked properly, engage the first gear of the tractor, and press the gas pedal, when you are slowly releasing the clutch, you will feel that the tractor strives to move the semi-trailer, this indicates that the connection is made properly. During the travel, this connection must be checked carefully to prevent separation of the semi-trailer from the tractor accidentally.

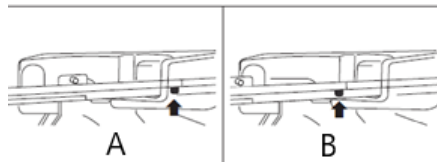
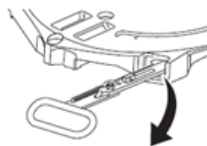

Fifth wheel locking system

A- Locked

B- Unlocked

5.3. Cautions During the Parking and Stopping

- Involuntary trailer movements, unstable posture and insufficient safety at night may occur serious accidents and injuries.
- Use the parking brake and wheel chocks while stopping.
- If you are going to park the vehicle in a public traffic area, you must use the necessary marking plate in accordance with legal regulations.

5.4. Important Technical Considerations

5.4.1. Fire Extinguisher

Please check fire extinguishers periodically every year and fill them up if

necessary. In case of any usage of the fire extinguishers, fill it up immediately.

Precautions to be taken in case of fire.

Some sealing materials let out gas when burned and these gases may become abrasive acid in contact with water. Thus never touch the fire extinguisher liquid accumulations without wearing protective gloves.



Fire Extinguisher Box

5.4.2. Wheel Chocks

Keep the wheel chocks in their place and place them under the wheels during park-ing. Do not forget to remove the wheel chocks before setting off.



Wheel chocks

5.4.3. Modifications on the Trailer

Repairing and modification operations must be made by only authorized services. Otherwise, your vehicle may be out of warranty.

5.4.4. Air Leakage

In case the air pressure in the air tubes drops instantly with the engine stop, this means that there is a leakage in the pneumatic system. Contact the nearest authorized service in such a case. The air leakage not only affects the safety of the braking system but also negatively affects the load lifting capacity of airbags.

5.4.5. Welding

Never do any welding work on the vehicle body and chassis. Disconnect the vehicle's electrical connection from the tractor before welding on the parts. It is recommended that you disconnect the tractor as well. Connect the minus (-) end of the welding machine as close as possible to the welded part in order to ensure sufficient contact with the part to be welded. Do not connect the negative (-) end to the bracket holders or the axle. Take care that welding sparks or slags do not fall on the bellows, air hoses, bracket holders etc.

Do not make any welding interventions to the tankers without gas-free (gas-free cleaning process) and gas measurement results without reliable gas-free certificate. Otherwise, there will be risks of explosion, fire and work accident due to the petroleum products transported.

5.4.6. Considerations For the Environment

Pollution in all its forms poses a threat to the environment. To keep the pollution at a minimum, collect the waste materials carefully and dispose of them in accordance with the regulations of your country.

ENVIRONMENT - Disposal of the battery in an inappropriate place may harm the environment and human health. If you need to dispose of the battery, follow

local regulations. If you do not know how to dispose of it, take it to the most appropriate service point. The symbol on the battery indicates that this product should not be disposed of.



Health and Safety

- Keep sparks and fire away from the battery. The battery emits explosive gas that can cause an explosion.
- Wear eye protection and rubber gloves while working on the battery, otherwise the battery hand control may cause burn and serious damage including blindness in your eyes.
- Under no circumstances allow children to handle the battery. Make sure that anyone dealing with the battery is familiar with the proper use of the battery and its hazards.
- Pay close attention to the battery electrolyte as it contains diluted sulfuric acid. Contact with your skin and eyes may cause burns or loss of eyesight.
- Carefully read and understand this manual before working on the battery. Failure to follow instructions may result in injury and vehicle damage.
- Do not use the battery if the electrolyte level is at or below the recommended level. Using the battery with a low electrolyte level can cause explosion and serious injury.

If there are wasted oil and wasted oil contact materials in your vehicle, pay attention to the following warnings.

When disposing of products/wastes such as used oil, hydraulic oil, do not discharge into channels, sewers, landfills, or soil. This is against the legislation of all countries.

This rule also applies to empty containers in contact with oil, chemical materials, and waste of cleaning cloths. Take these wastes to the relevant authorities or the most appropriate service point for disposal.

If your vehicle tire has expired;

The end-of-life tire must be disposed of in accordance with the regulations. For this, take your expired tire to the relevant authorities or appropriate service points.

If you carry dangerous chemicals in your vehicle;

In case of an accident or emergency that may occur during transportation, act in accordance with the Written Instructions of the ADR Legislation.

From the trailer's life-cycle perspective, it is important to recycle the end-of-life vehicle in an environmentally friendly manner. A large part of the trailer consists of recyclable materials. Contact the approved company and appropriate service for the recycling of the trailer that has expired.

5.5. Cleaning of the Vehicle



After transporting certain materials which are dangerous to human health, it is too risky for health to enter to the silo tank for cleaning. Only enter to the silo tank if it is absolutely necessary. Before entering to the silo tank, perform a gas measurement according to the applicable regulations. Make sure the silo vehicle is clean by checking it on a daily basis.

These controls should be applied especially to couplings and to equipment used for loading and unloading. Dirt and

product residues should be cleaned immediately.

Driver's cab should be kept clean and in order.

Warning signs, reminders and sticky labels should be kept clean. Damaged and invisible signs and labels should be replaced as soon as possible.

 **Make sure that the silo is cleaned by authorized services and cleaning firms that are specialists on cleaning the silos.**

Before Cleaning the Silo Vehicle:

- Make sure that the silo tank has been fully discharged and that there is no product residue left in the fittings, couplings and hoses.
- Make sure that the silo tank is depressurized,
- Make sure that potential conductors are connected.

 **Product residue can mix into the air line. Product residues mixed in the air lines can cause products that are subsequently loaded to become sticky or contaminated, which can cause considerable material damage. Depending on the products loaded, the air lines should be cleaned.**

 **Incompatible cleaning agents can damage the silo tank and its sealants. Only cleaning agents that are compatible with the silo tank and its sealants should be used.**

Air Lines:

- If the air lines are also to be cleaned, all the valves must be opened before cleaning begins.

 **When a silo tank that has been hot-cleaned cools down, vacuum damage can occur if the silo tank is insufficiently vented. Make sure that there is sufficient ventilation via the manholes and valves.**

 **Do not use the inflammable liquid or toxic substance for cleaning works.**

External Cleaning:

 **Newly painted surfaces can only be cleaned after a 4-week paint stiffening period. Cleaning done before this can damage the paint. During the first 4 weeks, the silo vehicle should only be washed with cold water jet. Do not use pressurized water jets or hard brushes.**

 **After 4 weeks: Washing painted surfaces with high-temperature water or abrasive cleaning materials may damage the paint**

- Wash the external of the silo only with water at a temperature below 60°C.
- Do not use abrasive cleaning detergents.
- Maintain the minimum distance required when using high-pressure water jet.

When cleaning the external of the vehicle:

- Clean the outpouring load as soon as possible.
- Clean the residues of road salts regularly, as soon as possible.
- Clean the silo vehicle once a week with a little water and a mild, non-corrosive detergent.

If you are cleaning with high pressure:

- Maintain minimum distance of 70 cm between the circular nozzle and the surface being cleaned.
- Maintain minimum distance of 30 cm between the flat nozzle and the surface being cleaned.

- Do not direct water on electrical components, receptacle connections, seal rings or hoses.

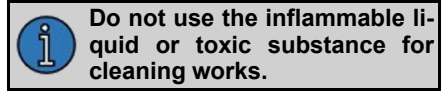

6. TRANSPORTATION SOLUTIONS

6.1. Customs Legislation

The vehicle must be manufactured in such a way that no material can be removed from the sealed part or placed inside the vehicle without breaking the customs seal or leaving any visible traces.

Customs clearance should be easily applied to the vehicle.

There should be no compartments in the vehicle where items can be hidden.

It should be easily accessible to the sections where customs control will be carried out in the vehicle.

6.1.1. Semi-Trailer Structure Compliant with Customs Legislation

In order for a semi-trailer to comply with the customs legislation;

- The parts that make up the semi-trailer must be put together in such a way that they cannot be removed from the outside and replaced, or replaced without leaving any obvious traces.
- There must be a device on which the customs seal can be applied on other closing systems.
- Ventilation holes must contain a device to prevent entry into the vehicle or placing material inside, and the device must not be opened from the outside without leaving a clear trace.
- After the silo tank is filled, the customs clearance process starts from the tank top front clearance box by tightening all the covers, passing through the manhole covers, passes the rear discharge cone through the wing nuts, and by bringing to the

tank rear right lower customs clearance box, clearance is made.

6.2. Dangerous Goods Transportation (ADR)

Vehicles carrying dangerous goods should keep this plate in open position while driving. It is located at the rear of the vehicle, but its exact location may vary according to the construction of the vehicle. The ADR plate is defined in the R105 legislation. Approved vehicles in accordance with ADR legislation must have an ADR identification plate.

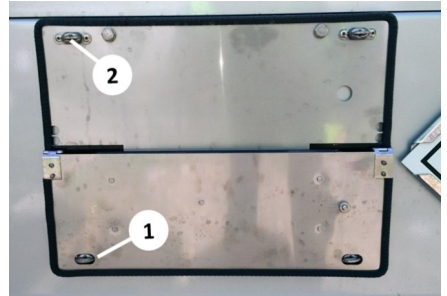

Opening ADR plate



ADR plate latches

Opening the plate: Open the plate in the closed position upwards by turning the latch (1) clockwise or counterclockwise by 90°, attach the opened flap of the plate to the latch (2) on the other side and fix it in the same way as the opening procedure.

7. LOADING AND LOAD SECURITY

7.1. Loading and Discharging Tipping Silo Vehicle



Tipping Silo

7.1.1. Safety Precautions

Be sure of even load distribution, assuring that all laws, rules and regulations are complied with. During loading keep in mind the net volume, total weight and axle load capacities. For the running gear and upper connection plate of the vehicle, do not load more than the load limitations, which are defined in the user's manual and name plate/label of the vehicle. Comply especially with national rules of the destination country!



If the silo vehicle is tail-heavy or top-heavy, especially if the tank is excessively fully loaded, the driving and braking characteristics of the silo vehicle are impaired. This has an increased accident risk.

- Load the material as evenly as possible.
- Pay attention to the permitted silo vehicle and axle loads.
- Pay attention to the minimum and maximum filling levels.

7.1.2. Load Distribution and Load Limits of Tractor – Semi Trailer Combination

- Be sure of even load distribution, assuring that all laws, rules and regulations are complied with.
- During loading keep in mind the net volume, total weight and axle load capacities.
- Make sure the loading complies with all rules and laws that are applicable in the countries of use.

Due to the various loading conditions of the tractor/semi trailer combination the axle loads* can vary considerably. Observe the permitted axle loads as set forth in the user's manual or documents of axles' manufacturer. In case of doubt have the axle loads inspected in a suitable weighing station.

***Axle load: It is the load, which is delivered to the road by an axle or axle group.**

7.1.3. Considerations During Loading – Unloading



There is a risk of injury from unprofessional loading and unloading operations.

Safety reminder

- During the loading/unloading operations, the parking brake must be activated, and the vehicle must be fixed with wheel chocks.
- To prevent slipping, tipping or sinking of the vehicle, the vehicle must be parked on a flat and firm surface.
- Ensure that you made a proper load distribution in compliance with all laws, rules and regulations.
- The suspension of the vehicle may be raised during the loading/ unloading process. Because of this reason, the vehicle height may be bigger than the permitted height limits. Always set the trailer in the driving position after loading and unloading. Always check height limits when entering tunnels and passages.
- Make sure that the weight or dimensions of the load do not exceed the technical and legal limits.
- Note that vehicle stability may be affected by the load distribution, the braking distance may be longer and a larger turning radius may be required.
- During loading, consider the laws of the countries you are going to and passing through, as well as the laws.
- Give attention to the maximum axle weight and total weight.
- Comply all national/international laws, rules, and regulations about loading and occupational safety.

7.1.4. Loading Preparation

Keep available and wear the appropriate protective equipment, depending on the material to be loaded. Follow ADR regulations and material safety instructions.

Depending on the previous load that was transported, get the silo vehicle properly cleaned before you make a new loading.

Only get onto the silo tank when the folding handrail is raised and if the vehicle is secured against accidental movement.

- The handbrake of the vehicle must be engaged.
- The vehicle must be level.

Before loading, make sure of the following:

- Check the shipper's safety precautions,
- Check to see that all the couplings are secure,
- Make sure of the compatibility of the product that is to be loaded with the materials of the vehicle and its seals.



Product residues in the tank can contaminate the products in the subsequent loading and makes them unusable. Clean inside the tank if they get dirty. You can fill any load that is permitted for the silo vehicle via manholes or via the filling neck.



If you loosen or tighten the manholes under pressure, the manhole can tear away explosively from the silo tank and hit you or other people.

- **Never attempt to open the clamps of a pressurized manhole.**
- **Don't remove the blind cover from a coupling that is under pressure. Connect the material**

hoses before the system is pressurized.

- Boşaltma konisinin kilitlerini asla sistem basınç altındayken açmaya çalışmayın

7.1.5. Loading

You can check the pressure in the silo tank by means of the manometers. Open the ventilating valve (1).

 **In normal status the ventilation valve must be “open”, while pressurized discharging is performed the ventilation valve should be “closed”.**

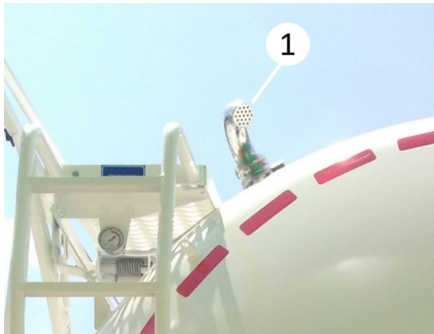

Ventilating valve

Depending on the product, observe the specified filling levels.

Preparing to fill

Connect the potential conductor (if equipped).

 **If the potential conductor is not connected, static charges can cause sparks and thus explosions.**

- Connect the potential conductor while filling, emptying and cleaning.
- Check that the silo vehicle is not pressurized. If it is pressurized, use the ventilating valve to remove all the air from the silo vehicle.

- Check that all the shut-off devices such as discharge cone, material emptying couplings gate valves, blind covers, ball valves are closed.
- Depending on the loading method, open one of the manhole cover or loading couplings to vent the tank.

Start loading

- Insert the loading nozzle into the manhole (2) or connect the loading hose to a loading coupling (3).

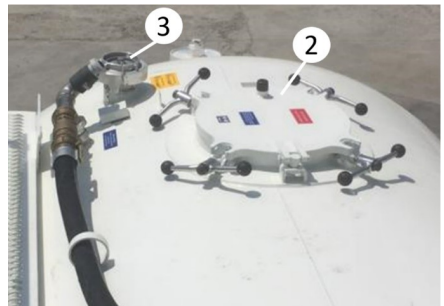

Filling manhole and filling neck

- Authorize the loading personnel to begin the loading procedure.
- Load the silo tank evenly via the manholes or loading coupling.
- Monitor the loading procedure.

Terminate the loading procedure

- Check whether the product flow has stopped.
- Pull out the loading nozzle or remove the loading hose from the loading coupling.
- Close the manhole or loading coupling.
- The ventilation valve (1) opened before starting loading must remain open until pressurized discharge is made.

Stop loading

- Close all the valves in the air lines and material hoses and fit the blind covers.
- Disconnect the potential conductor.
- Retract the folding handrail.
- Check the load distribution (min / max) filling level.
- Install warning signs if you are carrying dangerous goods.

7.1.6. Discharging

Keep available and wear the appropriate protective equipment, depending on the material to be discharged. Follow ADR regulations and material safety instructions.

Only get onto the silo tank when the folding handrail is raised and if the vehicle is secured against accidental movement.

- The handbrake of the vehicle must be engaged.
- The vehicle must be level.

The following procedures can be followed to empty the silo tank:

Gravity discharge (discharging onto the ground): Emptying without auxiliary equipment. Simply allowing the product to flow under gravity.



When gravity discharge is made (with gravity, without giving air into the tank), one of the manhole cover must be opened before starting the discharge.

Compressed air discharge: Emptying the silo vehicle with the help of compressed air. The compressed air is supplied from an external or on board compressor.

When selecting an unloading procedure, please take the following factors into account:

- Product type and characteristics
- On-site conditions
- Climate characteristics

Preparing to discharge

- Park the vehicle on a firm, even ground.
- Lower the landing legs of the vehicle and get it in a level position horizontally.
- Deflate the air suspension of the tractor and trailer.
- Check that all the manhole cover and connections are closed.
- Connect the air battery to the compressor via the side air line (1).



For using instructions of the compressor, see the manufacturer's user's manual.



Side air line

- Connect the fluidiser air coupling to the corresponding coupling (1) of the discharge cone.
- Connect the discharge elbow (2) to the discharge cone's material coupling. (3)
- Connect the discharge elbow to the jet air coupling (4) of the air battery.

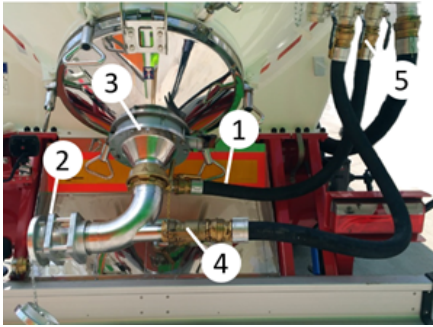

Components on discharge cone

- Connect the material hose to the discharge cone by means of discharge elbow (5).

When connecting the air battery and discharge cone and the discharge elbow, ensure that right couplings are used. If not, this can lead to malfunctions during the unloading process.

If required, you can mount an adapter with a sight glass (optional) between the discharge elbow and the material hose. This adapter enables you to check that the load is being emptied continuously.

Start discharging

- Make the hydraulic connections.
- Using the hydraulic tip-over mechanism, raise the silo tank with the control levers.
- Start the compressor.
- The pressure in the silo tank increases slowly.

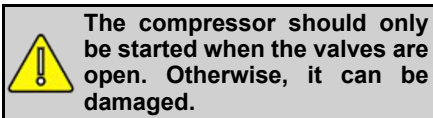

- Keep only the valve (7) of the top air line (6) open until the in-side pressure of the silo tank is 2 bar.



Top air line

- After the pressure reaches 2 bar, depending on the load, fluidise with the required pressure via the stop valve and adjust it accordingly during emptying.

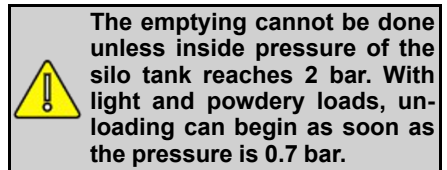

- Open the jet air valve on the air battery fully in a very short time and check the pressure on the manometer.

If no pressure is shown, the material hose is empty. Discharge can begin.

If the pressure is constant, the material hose is blocked. The reason for the blockage must be determined and remedied.

- Start discharging.
 - Open the on-off valve on the material coupling.
- « Product is forced out of the silo tank with pressure.

- Monitor the unloading process and the pressure. Do not go away from the silo vehicle.

The valves for fluidiser air, jet air and top air on the air battery are used to control the pressure in the silo tank and thus the

material flow. Depending on the type of load, you may have to adjust the air supply from the air battery accordingly.



Do not raise the fully loaded silo tank completely. First raise the silo tank in first of the three steps of the piston, after the half of the silo tank is emptied, raise completely.

Finish discharging

- Open and close the stop valve for fluidiser air several times.
- Stop the compressed air supply by switching off the compressor.
- Close the on-off valve on the material coupling.
- Close the stop valves of the top air and fluidiser air.

Terminate discharging

- Lower the silo tank slowly.
- Slowly ventilate the silo tank by means of the venting valve (8). Leave the ventilation valve open until the next time the tank is loaded in order to avoid vacuum damage.



Ventilation valve



Wear goggles when releasing the remaining pressure.

- Wear goggles when releasing the remaining pressure.
- While the silo tank is empty, leave the ventilation valve open in order to avoid vacuum damage.
- Uncouple the air lines and the material hose.
- Retract the folding handrail.
- Retract the rear landing legs.
- Set the suspension to the drive position.

7.1.6.1. Discharge With Hydraulic Pump

For discharging procedure firstly a compressor must be provided (a compressor which generates pressure of 2 bar in the tank, has air intake flow of minimum 500-600 m³ / h, has the power of 40 KW is needed.)

In order for the pump to work, an electrical connection must be made to the tractor with the NATO socket in the socket holder area.



Connection coupling

Connection of the compressor to the vehicle's air line; It is made with the connecting coupling (1) in front of the side air line. The air line is connected to the air battery located at the rear of the vehicle with a coupling.



Side air line

The discharge elbow should be coupled to the discharge cone end.

While the air ventilation valve, the fluidization valve going to the discharge cone, the jet air valve to the discharge line are closed, the top air line (air line entering the tank from the top of the tank) valve should be opened and the internal pressure of the tank should be expected to rise up to 2 bar with the compressed air supplied from the compressor. This pressure value of 2 bars can be seen from 2 manometers on the air line.

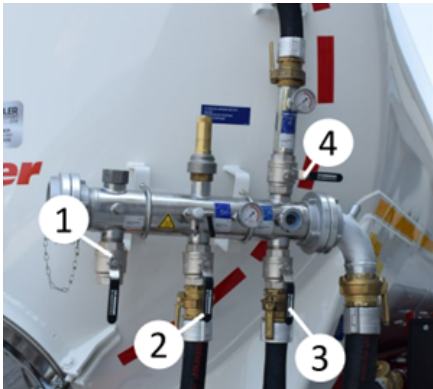

Air battery

- 1- Air ventilation
- 2- Jet air line
- 3- Fluidiser line
- 4- Top air line

When the internal pressure of the tank reaches 2 bar (it reaches this value in 1.5-2 minutes with the appropriate compressor), open the connection of the jet air line, open the discharge valve and start the discharge of the material. First, open the fluidization valve in the collector a quarter, in order to prevent the flow of material from accumulating in the discharge cone. After the flow starts, open it fully so that the flow accelerates.

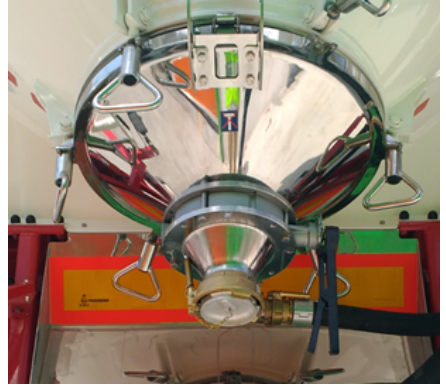

Discharge cone

Activate the hydraulic pump by opening the pump start button next to the pneumatic control. By pressing the pneumatic control lever in the lifting direction, lift the front of the tank with the hydraulic lifting cylinder so that the material flow to the rear. Raise and lower the tank lift cylinder with the joystick, and the lowering of the tank can be achieved by using the hydraulic valve at the front.



Hydraulic control panel



Hydraulic pump

 **For using instructions and warranty terms of the hydraulic pump, see the manufacturer's user's manual.**

Activate the vibrator located at the front and/or rear of the tank to spill the materials adhering to the inner wall of the tank.

When discharge is complete, turn off the compressor, disconnect the compressor from the air line, turn off all valves on the vehicle.

 **Before start discharging, vehicles with mechanical or hydraulic landing leg at the rear should be lowered to the ground and the vehicle should be leveled.**



Landing leg



Water scale



When the tank is full, the tank must be raised as attached to the tractor. The tank can only be raised on mechanical feet when it is empty.



Do not raise the fully loaded silo tank completely. First raise the silo tank in first of the three steps of the piston, after the half of the silo tank is emptied, raise completely.



For vehicles without rear support legs, unloading must be carried out while the vehicle is in the driving (travel) position.

7.1.6.2. Discharge Without Hyd-raulic Pump

There is a hydraulic cylinder at the front of the tipping silo that enables the tank to be raised.

Hydraulic cylinder movement is provided by using the hydraulic oil and oil pump on the tractor.

(There is no hydraulic oil and oil tank where the oil is stored as standard on the trailer.)

Cylinder connection hoses on the trailer must be connected to the hydraulic pump and oil tank on the tractor with hydraulic couplings.



The pump connection of the tractor must be connected to the pressure line on the trailer, the oil tank connections of the tractor must be connected to the return line on the trailer.

As an option, the hydraulic system in tipping silo is made on the trailer with pump + oil + oil tank.

The oil required for the lift cylinder is stored in the oil tank mounted on the trailer chassis, the electro-hydraulic pump (24 volts) is also mounted on the trailer and pressurized oil is sent to the cylinder by this pump.

The electricity required for the operation of the electro-hydraulic pump is taken from the accumulator on the tractor. The electrical cable/socket connection between the accumulator and the pump should be made when the pump is to be operated, and the connection should not be made when the pump is not running.

For discharging procedure firstly a compressor must be provided (a compressor which generates pressure of 2 bar in the tank, has air intake flow of minimum 500-600 m³ / h, has the power of 40 KW is needed.)

Hydraulic connection hoses should be connected to the tractor and the hydraulic cylinder should be made operational.

Connection of the compressor to the vehicle's air line; It is made with the connecting coupling in front of the side air line. The air line is connected to the air battery located at the rear of the vehicle with a coupling.



Side air line

The discharge elbow should be coupled to the discharge cone end.



Discharge cone

While the air ventilation valve (1), the fluidization valve (3) going to the discharge cone, the jet air valve (2) to the discharge line are closed, the top air line (air line entering the tank from the top of the tank) valve (4) should be opened and the internal pressure of the tank should be expected to rise up to 2 bar with the compressed air supplied from the compressor. This pressure value of 2 bars can be seen from 2 manometers on the air line.

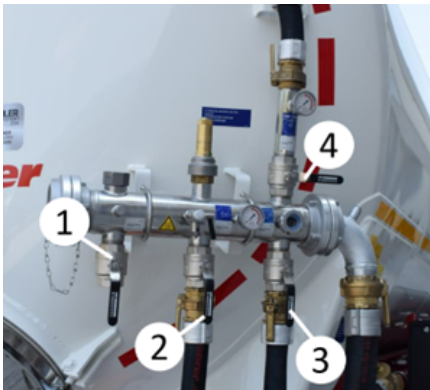

Air battery

When the internal pressure of the tank reaches 2 bar (it reaches this value in 1.5-2 minutes with the appropriate compressor), open the connection of the jet air line, open the discharge valve and start the discharge of the material. First, open the fluidization valve in the collector a quarter, in order to prevent the flow

of material from accumulating in the outlet cone. After the flow starts, open it fully so that the flow accelerates.

Activate the vibrator located at the front and/or rear of the tank to spill the materials adhering to the inner wall of the tank.

When discharge is complete, turn off the compressor, disconnect the compressor from the air line, turn off all valves on the vehicle.



Before start discharging, vehicles with mechanical or hydraulic landing leg at the rear should be lowered to the ground and the vehicle should be leveled.



Landing leg



Water scale



When the tank is full, the tank must be raised as attached to the tractor. The tank can only be raised on mechanical feet when it is empty.



Do not raise the fully loaded silo tank completely. First raise the silo tank in first of the three steps of the piston, after the half of the silo tank is emptied, raise completely.



For vehicles without rear support legs, unloading must be carried out while the vehicle is in the driving (travel) position.

7.2. Loading and Discharging Silo Vehicle



Silo

7.2.1. Safety Precautions

Be sure of even load distribution, assuring that all laws, rules and regulations are complied with. During loading keep in mind the net volume, total weight and axle load capacities. For the running gear and upper connection plate of the vehicle, do not load more than the load limitations, which are defined in the user's manual and name plate/label of the vehicle. Comply especially with national rules of the destination country!



If the silo vehicle is tail-heavy or top-heavy, especially if the tank is excessively fully loaded, the driving and braking characteristics of the silo vehicle are impaired. This has an increased accident risk.

- Load the material as evenly as possible.
- Pay attention to the permitted silo vehicle and axle loads.
- Pay attention to the minimum and maximum filling levels.

7.2.2. Load Distribution and Load Limits of Tractor – Semi Trailer Combination

- Be sure of even load distribution, assuring that all laws, rules and regulations are complied with.
- During loading keep in mind the net volume, total weight and axle load capacities.
- Make sure the loading complies with all rules and laws that are applicable in the countries of use.

Due to the various loading conditions of the tractor/semi trailer combination the axle loads* can vary considerably. Observe the permitted axle loads as set forth in the user's manual or documents of axles' manufacturer. In case of doubt have the axle loads inspected in a suitable weighing station.

***Axle load: It is the load, which is delivered to the road by an axle or axle group.**

7.2.3. Considerations During Loading – Unloading



There is a risk of injury from unprofessional loading and unloading operations.

Safety reminder

- During the loading/unloading operations, the parking brake must be activated, and the vehicle must be fixed with wheel chocks.
- To prevent slipping, tipping or sinking of the vehicle, the vehicle must be parked on a flat and firm surface.
- Ensure that you made a proper load distribution in compliance with all laws, rules and regulations.
- The suspension of the vehicle may be raised during the loading/ unloading process. Because of this reason, the vehicle height may be bigger than the permitted height limits. Always set the trailer in the driving position after loading and unloading. Always check height limits when entering tunnels and passages.
- Make sure that the weight or dimensions of the load do not exceed the technical and legal limits.
- Note that vehicle stability may be affected by the load distribution, the braking distance may be longer and a larger turning radius may be required.
- During loading, consider the laws of the countries you are going to and passing through, as well as the laws.
- Give attention to the maximum axle weight and total weight.
- Comply all national/international laws, rules, and regulations about loading and occupational safety.

7.2.4. Loading Preparation

Keep available and wear the appropriate protective equipment, depending on the material to be loaded. Follow ADR regulations and material safety instructions.

Depending on the previous load that was transported, get the silo vehicle properly cleaned before you make a new loading.

Only get onto the silo tank when the folding handrail is raised and if the vehicle is secured against accidental movement.

- The handbrake of the vehicle must be engaged.
- The vehicle must be level.

Before loading, make sure of the following:

- Check the shipper's safety precautions,
- Check to see that all the copu-lings are secure,
- Make sure of the compatibility of the product that is to be loaded with the materials of the vehicle and its seals.

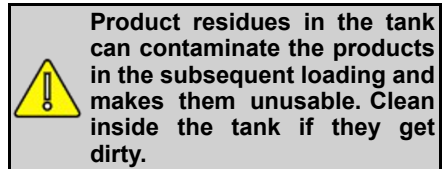

You can fill any load that is permitted for the silo vehicle via manholes or via the filling neck.

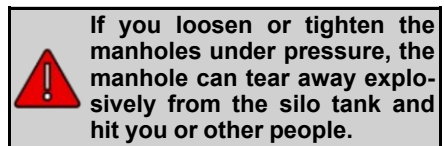

- Never attempt to open the clamps of a pressurized manhole.
- Don't remove the blind cover from a coupling that is under pressure. Connect the material hoses before the system is pressurized.
- Never attempt to loosen or tighten the clamps of a discharge cone that is under pressure.

7.2.5. Loading

You can check the pressure in the silo tank by means of the manometers. If necessary, you must open the ventilating valve (1).



Ventilating valve

Depending on the product, observe the specified filling levels.

Preparing to fill

Connect the potential conductor (if equipped).

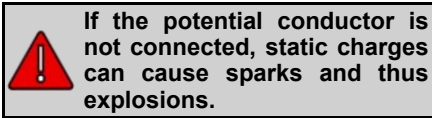

- Connect the potential conductor while filling, emptying and cleaning.
- Check that the silo vehicle is not pressurized. If it is pressurized, use the ventilating valve to remove all the air from the silo vehicle.
- Check that all the shut-off devices such as discharge cone, material emptying couplings gate valves, blind covers, ball valves are closed.
- Depending on the loading method, open one of the manhole cover or loading couplings to vent the tank.

Start loading

- Insert the loading nozzle into the manhole (2) or connect the loading hose to a loading coupling (3).

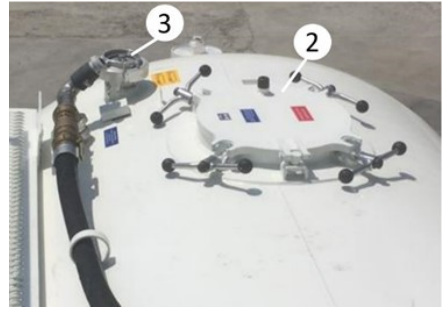

Filling manhole and filling neck

- Authorize the loading personnel to begin the loading procedure.
- Load the silo tank evenly via the manholes or loading coupling.
- Monitor the loading procedure.

Terminate the loading procedure

- Pull out the loading nozzle or remove the loading hose from the loading coupling.
- Close the manhole or loading coupling.
- The ventilation valve (1) opened before starting loading must remain open until pressurized discharge is made.

Stop loading

- Close all the valves in the air lines and material hoses and fit the blind covers.
- Disconnect the potential conductor.
- Retract the folding handrail.
- Check the load distribution (min / max) filling level.
- Install warning signs if you are carrying dangerous goods.



Air discharge valve

7.2.6. Discharging

Keep available and wear the appropriate protective equipment, depending on the material to be discharged. Follow ADR regulations and material safety instructions.

Only get onto the silo tank when the folding handrail is raised and if the vehicle is secured against accidental movement.

- The handbrake of the vehicle must be engaged.
- The vehicle must be level.

The following procedures can be followed to empty the silo tank:

Gravity discharge (discharging onto the ground): Emptying without auxiliary equipment. Simply allowing the product to flow under gravity.

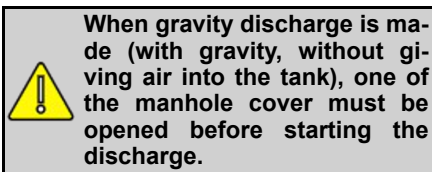

Compressed air discharge: Emptying the silo vehicle with the help of compressed air. The compressed air is supplied from an external or on board compressor.

When selecting an unloading procedure, please take the following factors into account:

- Product type and characteristics

- On-site conditions
- Climate characteristics

7.2.6.1. Discharge With Compressor

The required air when the silo tank is unloaded can be supplied externally, but also it can be supplied from the compressor which is generally mounted in front of the vehicle according to the customer's demand.

See the manufacturer's user's manual for operating instructions of compressor and for more detailed information.

Connection of the compressor to the vehicle's air line; It is made with the connecting coupling (1) in front, middle or rear of the side air line.

Connect the end of the discharge line located at the rear or side of the vehicle to the discharge line of the ground silo in the facility.

Start the compressor, wait until 2 bar pressure is observed in the air line.

Open the fluidizing air of the first cone.

Open the jet air halfway.

Keep the pinch valve of the first cone open until about ¾ of this cone is empty.

Close first cone pinch valve, fluidizer air and jet air.

- Jet air (1st cone) (1)
- Fluidiser air (1st cone) (2))
- Jet air (2nd cone) (3)
- Fluidiser air (2nd cone) (4)

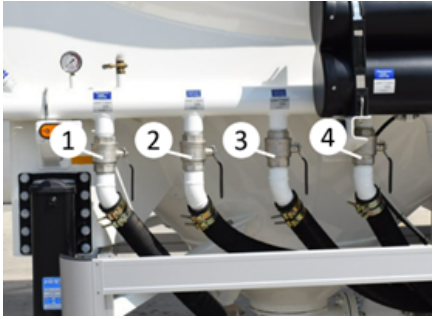

Collector

- Open the fluidizer air of the second cone completely and the jet air half-way. Keep the pinch valve of this cone in the open position until the second cone is completely empty.
- Then close all valves of the second cone and discharge the remaining material from the first cone.
- Ensure complete emptying of the line by opening and closing the pinch valves.
- Remove and replace the discharging hose.
- Ventilate the silobas vehicle

When the silo vehicle is completely empty, the manometers on the air line will show 0 (zero) bar.

When discharging is complete, turn off the compressor, disconnect the compressor from the air line, close all valves on the vehicle (except the ventilating valve (7)).

5. Pressure relief valve
6. Manometer
7. Ventilating valve (Breathing valve)



Wear goggles when releasing the remaining pressure

- **Wear goggles when releasing the remaining pressure**
- **While the silo tank is empty, leave the ventilation valve open in order to avoid vacuum damage.**
- **The unloading operation may vary depending on the material to be unloaded and the station.**

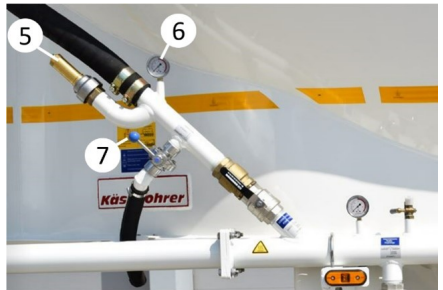

Top air line

7.2.6.2. Discharge Without Compressor

For discharging procedure firstly a compressor must be provided (a compressor which generates pressure of 2 bar in the tank, has air intake flow of minimum 500-600 m³ / h, has the power of 40 KW is needed.)

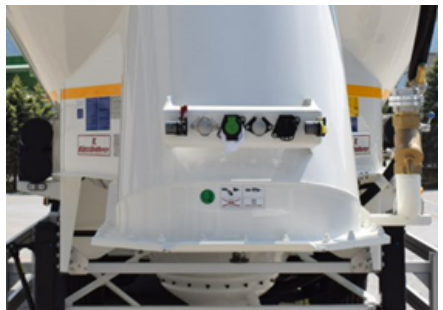

Coupling plate

Connection of the compressor to the vehicle's air line; It is made with the connecting coupling in front of the side air line.



Side air line



Discharge cone

Air ventilation valve, fluidization valve (2, 4) going to outlet cone and jet air valve (1, 3) going to discharge line are closed, by opening the top air line (air line entering the tank from the top of the tank) valve and with compressed air supplied from the compressor. Wait for the tank internal pressure to rise up to 2 bar. This pressure value of 2 bars can be read from 2 manometers on the air line.

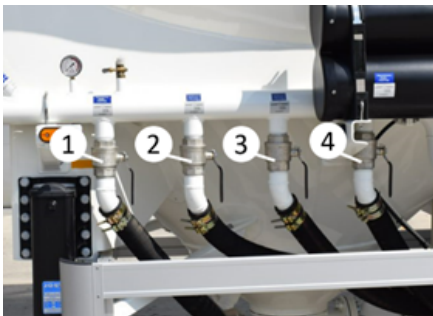

Collector

When the internal pressure of the tank reaches 2 bar (it reaches this value in 1.5-2 minutes with the appropriate compressor), open the connection of the jet air line, open the discharge valve and start the discharge of the material. First, open the fluidization valve in the collector a quarter, in order to prevent the flow of material from accumulating in the discharge cone. After the flow starts, open it fully so that the flow accelerates.

Activate the vibrator located at the front and/or rear of the tank to spill the materials adhering to the inner wall of the tank.

When discharge is complete, turn off the compressor, disconnect the compressor from the air line, turn off all valves on the vehicle.

7.3. Ferry Rings

Thanks to RO-RO rings, the vehicle may be fixed to the ferry during the ferry transportation. There might be welded type or bolted type RO-RO rings on your vehicle. Both types of RO-RO rings are used for the same purposes.



RO-RO rings



The vehicle cannot be lifted with these rings.

The support parts must be put at the king pin area during the ferry transportation without a tractor. The area that supports parts will be positioned, is marked with stickers.

8. INSPECTION AND MAINTENANCE

8.1. Safety Instructions

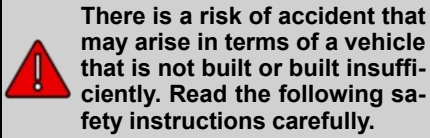

- Obey all traffic laws, rules and regulations.
- Comply with all environmental regulations. When removing operation, maintenance and cleaning residues, act according to these rules.
- In addition, ensure that the equipment used in the vehicle such as axles, landing gears, pump, counter, hose reel are checked and serviced at the intervals specified in the manufacturer's user manual.

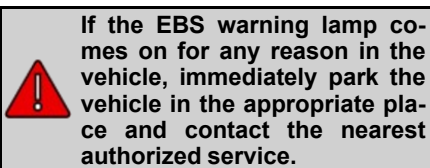
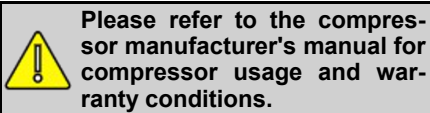
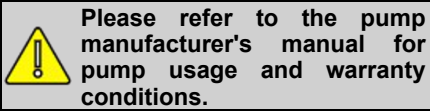

8.2. Main Principles

The purpose of the maintenance operations on the vehicle is to provide the following.

- Always maintain the operating status of the semi-trailer,
- To prevent unexpected breakdowns and to extend the life of the vehicle,

- To prevent permanent damage to the semi-trailer,
- To ensure that the semi-trailer maintains its value,
- Reducing repair time for unavoidable repairs.
- The vehicle should be regularly cleaned and kept clean.

8.3. Checks to Be Performed Of The Time of the Delivery

- Check that the electrical system and connections and all lighting elements, brake and signal lamps are working properly.
- Check that the documents of the vehicle are in the vehicle.
- Grease the wheel plate and king pin.
- Check the tightness of the wheel nuts.
- Check that the landing gear works in both speed ranges.

8.4. Manhole Covers

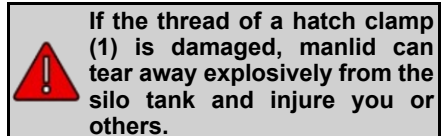

Hatch clamp

- The silo vehicle should never be placed under pressure even if only one thread is damaged.

- Always only hand tighten the hatch clamp crosswise.
- Replace damaged threads immediately.

Leak tightness

Small amounts of hissing air emerging while loading and unloading do not usually constitute a problem. However, none of the load should come out with the air.

Seals

The seals can only be checked when the silo vehicle is depressurized. The manhole cover must be open.

- Must be in visibly good condition.
- It must be clean. Replace damaged seals as soon as possible.

Hatch clamps

The manlid clamp threads,

- Must be in visibly good condition.
- Must be easy to move.

8.4.1. Gaskets

Gaskets and similar consumable materials may wear out and require replacement at different intervals depending on operational frequency, loading– unloading intensity, cleaning procedures, and operating conditions. Therefore, it is strongly recommended that these components be inspected regularly and replaced when necessary.

8.5. Discharge Cone

- The vehicle should never be pressurized, even if only one thread is damaged.
- Always only hand tighten the hatch clamp.
- Replace damaged threads immediately.

- Visually inspect the individual components to ensure that they are intact and in good condition.



Discharge cone

- The parts should show no damage and must be clean.
- No load residue must adhere to the sealing surface.
- The sealing surface should be smooth and even.
- The fluidiser air connection should not have any load residue adhering to it.
- The silo vehicle's seal must sit perfectly and not be twisted.
- The clamp thread must not be damaged and must operate easily.



If the threads of the discharge cone clamps are damaged, the discharge cone can tear away explosively from the silo vehicle body and injure or kill you or others.

8.6. Periodic Maintenance and Controls

For periodic maintenance and checks, see the warranty and maintenance manual.



For the validity of the warranty period, the first maintenance and annual periodic maintenance must be done at authorized services.

8.7. Important Warning!

- Check the lining thickness periodically. If the lining thickness has fallen below half, more frequent checks must be made and the lining must be changed by applying to the authorized service before the lining is finished. In the same way, the wear checks of the brake discs should be made periodically, and if there are excessive deformation and cracks on the disc surfaces, an authorized service should be immediately applied. In addition, the caliper piston and bellows should be visually checked and the operability should be checked by moving the caliper back and forth.
- For the necessary controls and periodic maintenance of the axles in your vehicle, the points in the service and maintenance instructions booklet given by the axle manufacturer with your vehicle should be applied meticulously and in accordance with the periods given in the same booklet. Failure to carry out such maintenance may affect the service life of the axles of the vehicle and may cause the axles to be out of warranty in case of a possible malfunction.
- The healthy operation of the brake system of the semi-trailer depends on the use of the semi-trailer with the same system and/or compatible tractor. For this reason, it is obligatory for the buyer to make the brake adjustment adjustment at the authorized service of the tractor company together with the tractor to which these semi-trailers / semi-trailers will be matched. In case the semi-trailer is paired and used with the tractor / tractors for which the

adjustment of the semi-trailer is not made or cannot be made, the malfunctions and damages that may occur in the brake system or the tractor and the semi-trailer are outside the responsibility of our company, and all responsibility in this regard belongs to the buyer.

8.8. Trouble Shooting

8.8.1. Safety Instructions



Risk of accident due to unprofessional troubleshooting.

Read the following safety regulations:

- Comply with all laws, rules, and regulations to prevent accidents.
- Comply with all environmental protection rules. Dispose of process residues, cleaning aids and other residues in accordance with these rules.
- Troubleshooting work should only be carried out by trained personnel.
- Before troubleshooting, park the vehicle on a firm, and even surface and level it, and make sure that it is secured against sliding/tipping.
- Upon completion of the repair, ensure that all protective devices are correctly placed and secured.
- Only use original spare parts!



In cold weather, ice may form on the floor. Care should be taken while walking.



For the repair process of the malfunctioning product, follow the instructions given by the manufacturer of that product in the user manual.

8.8.2. Spare Tire Replacement



Wheel nuts that are not tightened properly will loosen. This may cause accidents. Tighten the wheel nuts to the specified torque. You can find the torque values in the manufacturer's manual for "Axles". Check the tightness of the nuts immediately after each tire change.

Removing the tire:

- Park the vehicle in a safe place away from traffic.
- Secure the vehicle with wheel chocks against rolling away or tipping over.
- Apply the spring-loaded parking brake. (See:"Construction Components and Use of Semi-trailer" for detailed information.)



Lock the tractor securely to prevent spontaneous or unintentional movement of the tractor during tire changing.

- Loosen the wheel nuts only one turn.
- Place the lever jack under the axle as close as possible to the tire to be replaced.
- Raise the axle until the tire to be replaced is no longer in contact with the ground. Remove the wheel nuts.



Take the damaged wheel off the axle, grab the wheel only by the right and left cheeks, never remove it by holding the top or bottom.

Remove the spare tire from its holder. See spare tire holder section for detailed information.

Fitting The Spare Tire:

- Position the spare tire as close to the wheel hub as possible.
- Lightly oil the nut threads when refitting the wheel.
- Insert a bar directly under the tire and push the wheel bolts into the holes of the rim by leveraging. Be careful not to damage the threads of the studs during this process.
- Tighten the wheel nuts as much as possible by hand tightening.
- Tighten the nuts with the wrench in the order shown in the picture.
- Lower the jack and tighten the wheel nuts in the same sequence with the required torque. Repeat this process after the first 80 km and daily for the first week.

Check the wheel nuts for torque every week.



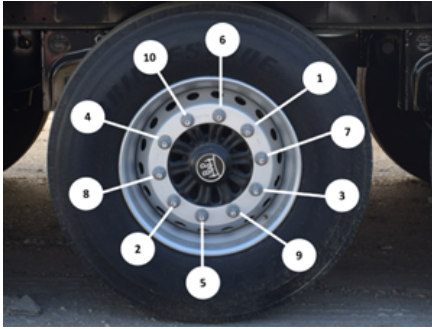

Possible problems that may arise in the future can be prevented by checking all the bolt holes on the rims against ovalization at regular intervals.

Excessive tightening of the nuts of the wheel bolts will cause radial deformations around the hole, and if not tightened enough, it will cause deformations around the hole.



Bolt holes in rims

 Follow all maintenance instructions, including those of the manufacturer of the vehicle parts, and always keep these instructions in your vehicle.

 The manufacturer cannot be held responsible for wear and defects caused by excessive force, or for malfunctions caused by unauthorized modifications. Irregularities or functional faults in the braking system must be rectified immediately! Only use vehicles whose brake system is functioning properly.

 There is a risk of burns if hot brake parts are touched.

8.8.3. Hydraulic System Maintenance

Hydraulic oil the hydraulic oil to be used in the trailer must be **ISO VG32 HLP**. This oil grade must always be observed when changing or adding hydraulic oil for any reason.



Hydraulic Suction Filter

The hydraulic suction filter must be replaced when the filter contamination indicator turns red.



Hydraulic Pressure Filter

The hydraulic pressure filter must be replaced once a year.



Kässbohrer Sales GmbH

Ulm | Im Katzenwinkel 5, 88480 Achstetten, Deutschland | T +49 (0) 7392 96797-0 | F +49 (0) 7392 96797-67

Goch | Siemensstraße 74, 47574 Deutschland | T +49 (0) 2823 9721-0 | F +49 (0) 2823 9721-21 | E info@kaessbohrer.com | www.kaessbohrer.com
info@kaessbohrer.com | spareparts@kaessbohrer.com | aftersales@kaessbohrer.com

Kässbohrer

Ingenuity, since 1893