



USER MANUAL  
**TANKER SERIES**



# Index

<b>1. GENERAL INFORMATION AND SAFETY INSTRUCTIONS</b>	
1.1. About the User Manual .....	9
1.2. Meanings of Symbols Used in User Manual.....	9
1.3. Personal Protective Equipments.....	10
1.4. Terms of Use and Safety Information .....	11
1.5. Possible Hazards .....	11
1.6. Danger Areas.....	12
1.7. Weather Conditions .....	13
<b>2. MAIN INFORMATIONS</b>	
2.1. Vehicle Identification Plate .....	14
2.2. Brake Data Plate.....	14
2.3. VIN (Chassis) Numbers .....	15
2.4. Warranty and Responsibility .....	15
<b>3. TRAILER RUNNING GEAR AND USAGE INSTRUCTIONS</b>	
3.1. Brake System .....	16
3.1.1. Air Couplings .....	16
3.1.2. Compressed Air Tanks .....	19
3.1.3. EBS Socket.....	19
3.1.4. Rollover Stability Support (RSS).....	20
3.1.5. PREV (Park Release Emergency Valve).....	20
3.1.6. Brake Chambers .....	21
3.2. Suspension System.....	23
3.2.1. Manuel Control .....	23
3.2.2. Auto Reset.....	23
3.2.3. Electronic Controlled Air Suspension (ECAS).....	24
3.3. Electrical System.....	24
3.3.1. 15 Pin Socket.....	24
3.3.2. 2x7 Pin Socket.....	25
3.3.3. Light System .....	26
3.4. King Pin .....	27
3.5. Landing Gear.....	28
3.5.1. Front Landing Gear's Working Principle.....	28
3.6. Side Protection Equipment (Underrun Protection) .....	29
3.7. Semi-Trailer Axle System.....	30
3.7.1. Self-Steering Axles .....	30
3.7.2. Axle Lifting.....	31

- 3.7.3. Hubodometer.....32
- 3.8. Tires .....32
- 3.9. Spare Wheel Holder .....33
  - 3.9.1. Crane Type Spare Wheel Holder.....34
  - 3.9.2. Basket Type Spare Wheel Holder .....34
- 3.10. Mudguards.....34
- 3.11. Wheel Chock.....35
  - 3.11.1. Pin Type Wheel Chock Holder.....35
  - 3.11.2. Pocket Type Wheel Chock Holder .....36
- 3.12. Boxes and Storage Units .....36
  - 3.12.1. Stainless Steel Toolbox .....36
  - 3.12.2. Steel Food Box.....36
  - 3.12.3. Plastic Toolbox.....37
  - 3.12.4. Fire Extinguisher Cabinet .....37
  - 3.12.5. Water Tank .....38
  - 3.12.6. Document Box .....39
  - 3.12.7. Fuel Tank.....39
  - 3.12.8. Armature Box.....39
  - 3.12.9. Armature Box Cover .....39
  - 3.12.10. Hose Carriers and Hose Holders .....40
  - 3.12.11. Working Lamp.....40
  - 3.12.12. Rear Bumper (Rear Protection Equipment) .....41
  - 3.12.13. Ladder, Walkway and Handrails .....41
  - 3.12.14. Lubrication System .....44
  - 3.12.15. Grounding Pins.....44
- 3.13. Warning Signs .....44

**4. UPPERSTRUCTURE COMPONENTS AND USE**

- 4.1. Bitumen (Tar) Tanker .....46
  - 4.1.1. Overview of Tank Components .....46
  - 4.1.2. Tank.....47
  - 4.1.3. Isolation Coating.....47
  - 4.1.4. Manhole Cover.....47
  - 4.1.5. Pressure Safety Valve.....48
  - 4.1.6. Ventilation Valves.....48
  - 4.1.7. Vacuum Valve.....49
  - 4.1.8. Side Air Line .....49
  - 4.1.9. Jet Air Line.....49
  - 4.1.10. Top Air Line.....50
  - 4.1.11. Bottom Valve.....50

4.1.12.	Safety Valve .....	51
4.1.13.	Remote Control System .....	52
4.1.14.	Sampling Valve .....	57
4.1.15.	Thermometer .....	57
4.1.16.	Manometer .....	58
4.1.17.	Heating Line.....	59
4.1.18.	Warning Signs On the Tank .....	60
4.2.	Chemical Tanker .....	60
4.2.1.	Overview of Tank Components .....	60
4.2.2.	Tank.....	62
4.2.3.	Isolation Coating .....	62
4.2.4.	Manhole Cover.....	62
4.2.5.	Pressure Safety Valve.....	63
4.2.6.	Vacuum Valve.....	63
4.2.7.	Blast Valve .....	64
4.2.8.	Jet Air Line.....	64
4.2.9.	Top Air Line.....	64
4.2.10.	Bottom Valve.....	65
4.2.11.	Safety Valve.....	66
4.2.12.	Sampling Valve .....	67
4.2.13.	Thermometer .....	67
4.2.14.	Manometer .....	67
4.2.15.	Drain Valves.....	67
4.2.16.	Heating Line.....	68
4.2.17.	Warning Signs On the Tank .....	69
4.3.	Food Tanker .....	70
4.3.1.	Overview of Tank Components .....	70
4.3.2.	Tank.....	71
4.3.3.	Isolation Coating .....	71
4.3.4.	Manhole Cover.....	71
4.3.5.	Breather Valve.....	72
4.3.6.	Cleaning Line.....	72
4.3.7.	Bottom Valve.....	73
4.3.8.	Discharge Valves.....	73
4.3.9.	Thermometer .....	74
4.3.10.	Drain Valves.....	74
4.4.	Waste Tanker .....	75
4.4.1.	Overview of Tank Components .....	75
4.4.2.	Tank.....	77

4.4.3.	Filling Manhole.....	77
4.4.4.	6" Pneumatic Control Gate Valve For Ventilation .....	77
4.4.5.	Safety Valve .....	77
4.4.6.	Vacuum Valve.....	77
4.4.7.	Pneumatic Valve for Tank Ventilation.....	78
4.4.8.	Pneumatic Overfill Protection For Stop The Pump .....	78
4.4.9.	Filling Funnel.....	78
4.4.10.	Filling Funnel 8” Pneumatic Control Gate Valve .....	78
4.4.11.	Tank Level Indicator .....	78
4.4.12.	6" Manual Control Gate Valve.....	79
4.4.13.	Perrot Coupling .....	79
4.4.14.	Turning Joint .....	79
4.4.15.	Pump .....	79
4.4.16.	3 Way Ball Valve.....	79
4.4.17.	Discharge Pump Outlet Line.....	80
4.4.18.	Tank Mixing Pump Inlet Line .....	80
4.4.19.	Discharge Pump Inlet Line.....	80
4.4.20.	Tank Mixing Pump Outlet Line .....	80
4.4.21.	Sampling Valve .....	80
4.4.22.	Perrot Coupling Cover .....	81
4.4.23.	Hydraulic Control Lever .....	81
4.4.24.	Hydraulic Pressure Gauge.....	81
4.4.25.	Pneumatic Valve.....	81
4.4.26.	Filling Funnel Valve.....	82
4.4.27.	Pneumatic Manometer .....	82
4.4.28.	Pneumatic Valve for Tank Ventilation.....	82
4.4.29.	Central Lubrication System.....	82
4.4.30.	Central Lubrication Electronic Counter System .....	83
4.4.31.	Central Lubrication On / Off Button.....	83
4.4.32.	Hydraulic Quick Coupling.....	83

## **5. TRANSPORTATION PROCESS**

5.1.	Pre-Driving Checks.....	84
5.2.	Semi-Trailer and Tractor Coupling.....	84
5.3.	Cautions During the Parking and Stopping.....	85
5.4.	Reversing Camera .....	85
5.5.	Important Technical Considerations .....	86
5.5.1.	Fire Extinguisher.....	86
5.5.2.	Wheel Chocks .....	86
5.5.3.	Modifications on the Trailer.....	86

5.5.4.	Air Leakage.....	86
5.5.5.	Oils.....	86
5.5.6.	Welding.....	87
5.5.7.	Spare Wheels.....	87
5.5.8.	Considerations For the Environment.....	87
5.6.	Cleaning of the Vehicle.....	88

## 6. TRANSPORTATION SOLUTION

6.1.	Dangerous Goods Transportation (ADR).....	90
6.2.	Transportation Compliant with ATP Legislation.....	90
6.3.	Chemical Substance Transportation.....	90

## 7. LOADING AND LOAD SECURITY

7.1.	Loading and Discharging of Bitumen (Tar) Tanker.....	92
7.1.1.	Safety Instructions.....	92
7.1.2.	Load Distribution and Load Limits of Tractor-Semi-trailer Combination.....	92
7.1.3.	Loading Preparation.....	93
7.1.4.	Loading.....	93
7.1.5.	Discharge.....	95
7.2.	Loading and Discharging of Chemical Tanker.....	98
7.2.1.	Safety Instructions.....	98
7.2.2.	Load Distribution and Load Limits of Tractor-Semi-trailer Combination.....	100
7.2.3.	Loading Preparation.....	100
7.2.4.	Loading.....	101
7.2.5.	Discharge.....	102
7.2.6.	Warnings for Filling and Discharging Operations.....	106
7.2.7.	Checks After Loading and Unloading.....	107
7.3.	Loading and Discharging of Food Tankers.....	107
7.3.1.	Safety Instructions.....	107
7.3.2.	Load Distribution and Load Limits of Tractor-Semi-trailer Combination.....	108
7.3.3.	Loading Preparation.....	108
7.3.4.	Loading.....	109
7.3.5.	Discharge.....	109
7.3.6.	Warnings for Filling and Discharging Operations.....	112
7.3.7.	Checks After Loading and Unloading.....	112
7.3.8.	STL Pumped Discharge.....	112
7.4.	Loading and Discharging of Waste Tankers.....	113

7.4.1.	Safety Instructions.....	113
7.4.2.	Load Distribution and Load Limits of Tractor-Semi-trailer Combination.....	114
7.4.3.	Loading .....	115
7.4.4.	Discharge.....	117
7.4.5.	Warnings for Filling and Discharging Operations .....	120
7.4.6.	Checks After Loading and Unloading.....	120

## **8. INSPECTION AND MAINTENANCE**

8.1.	Safety Instructions.....	121
8.2.	Main Principles .....	121
8.3.	Checks to Be Performed Of The Time of the Delivery .....	121
8.4.	Manhole Covers .....	121
8.5.	Cataphoresis Coating .....	122
8.6.	Galvanized Coating .....	122
8.7.	Periodic Maintenance and Controls .....	122
8.8.	Important Warning! .....	122
8.9.	Trouble Shooting.....	123
8.9.1.	Safety Instructions.....	123
8.9.2.	Spare Tire Replacement.....	123

## FOREWORD

First of all, thank you for choosing us for your new vehicle investment.

Your vehicle is manufactured with the latest production technologies to the highest quality standards and equipped with the best safety and efficiency features.

You can find detailed information about the accessories, equipment and hardware that might be in your vehicle in this manual. The defined options in this manual can vary according to the vehicle specs.

Important information on how you can use your vehicle is explained in this user manual, please be sure that you review and understand the content. We suggest keeping this user manual available in your vehicle at all times. This information is specified in the product's user manual. We recommend you read this operating manual thoroughly to get the most out of your vehicle.

*\* Owing to the developments in product research, the manufacturer reserves the right to make any changes in the product, without any prior notice. The publication rights of this documentation belong to the manufacturer.*

# 1. GENERAL INFORMATION AND SAFETY INSTRUCTIONS

## 1.1. About the User Manual

The usage and operation information given in this manual is prepared to make sure the vehicle is used in compliance with its purpose and as desired.

The instructions here contain important recommendations to perform your operations safely, completely, and in the most efficient manner. Complying with these instructions, warnings and recommendations will prevent accidents, decrease down-time / repair costs, and make sure you use your vehicle safely, reliably and problem-free.

Please read the operating instructions in this manual carefully and completely. The manufacturer is not liable for the damages and deficiencies caused by the failure to comply with these instructions. The instructions herein must be supported by local laws, rules and regulations. Please comply with these instructions to prevent accidents and protect your surroundings and the environment.

Any usage of transportation that goes beyond the use in accordance with the rules will be considered improper use.

Transportation of the following is not allowed:

- Carrying people and live animals
- Transportations that need to be carried according to special instructions, e.g., dangerous good transportations
- Transportation of unsecured goods
- Transportation of materials that are dangerous due to their properties or that need to be carried with special equipment
- Exceeding technically and legally permissible weights of the axles or king pin load

- Exceeding of the maximum vehicle speed
- Exceeding the permissible length, width and height
- Unapproved parts like tires, accessories, spare parts and etc. by the manufacturer

The manufacturer shall not accept any responsibility for the problems and faults that occurs that are not in compliance with the purpose of the vehicle's usage. All the risks of this issue belong to the customer.

 **It is necessary to keep the user manual available on the vehicle at all times.**

 **The vehicle can be equipped with a lot of different options. The standard or optional features will be explained in the manual. Some options may not be available for your vehicle.**

 **Adhere strictly to the operating instructions when using your vehicle. When problems occur which can lead to dangerous consequences, contact the service centre immediately.**

## 1.2. Meanings of Symbols Used in User Manual

Several warnings are available in this manual to ensure maximum safety when using your vehicle. Each warning is indicated by a special symbol. These symbols and their meanings are as follows.

 The information specified by this warning symbol is very important for health and human safety. When the given information is ignored, serious damage, injuries and even death may occur.

 This symbol specified in this manual indicates that critical accidents may occur when the instructions do not comply.

 This symbol is used when additional information is required.

 This symbol is used when chemicals and other substances can be disposed of with precautions that will not harm the environment.

### 1.3. Personal Protective Equipments

Personal protective equipments serves the purpose of preventing injuries and are prevents injuries and are determined by regional regulations depending on the load carried.

People who will work or perform operations on the vehicle must wear proper and appropriate protective clothing.

- Depending on the load to be carried, the eyes, ears, body, and respiratory tract must be protected with the relevant protective equipment.
- As a rule, gloves and work shoes are always used.

 It is obligatory to use appropriate personal protective equipment during the operations.

 Long hair is particularly dangerous when working on the vehicle, regardless of whether it is loose or tied up, and it should be protected properly to avoid tangling.

 Wearing a tie, necklace and/or dangling jewelry when working on the vehicle is strictly prohibited. They may get caught in moving parts or mechanisms and cause injuries and even death.

### Protective Gloves

 During the operation, protective gloves must be used. Please make sure you are using the correct type of gloves when you are working with hot parts or chemicals.

 Gloves should fit snugly. Otherwise, there is a risk of them getting caught in moving parts or mechanisms.

### Protective Cloth

 While working on the vehicle, appropriate overalls must be worn.

- Overalls should not have pleats, buttons or external pockets and their closure system should be made in such a way that they can be opened as soon as possible in case of an emergency.
- Interior pockets should have fastenings to close them up. Cuffs should be adjusted to fit the wrist.

### Protective Helmets



**When working around the vehicle, a lightweight helmet approved by an accredited institution should be worn.**

### Protective Ear Plugs



**A hearing protective device (headsets or ear plugs) should always be used around self-propelled vehicles.**

### Protective Goggles



**Protective goggles should be worn during all maintenance operations.**

### Protective Mask



**Appropriate protective masks should be used when working with substances that are dangerous to breathe or in dusty environments.**

## 1.4. Terms of Use and Safety Information

It is necessary to keep the warranty, operating and maintenance manual and other documentation about the vehicle available on the vehicle at all times.

## 1.5. Possible Hazards

Your tanker vehicle is manufactured with latest technology and appropriate to widely known technical safety rules. Nevertheless the risk of injury even death for driver and other persons and the risk of damage for vehicle and surrounding objects still exist.

A summary of dangers while operating on tanker. vehicle are described below. It is recommended to read these dangers carefully and completely.

To prevent possible accidents and environmental pollution, follow the operating instructions and binding regulations.

- Pay attention to the safety and warning signs placed on your vehicle.
- Always keep these safety and warning signs completely visible.
- Make sure that the load carrier is secured properly.
- In case of any dangerous condition in the operation of safety, stop your vehicle immediately and inform the authorized people or institutions.
- Do not modify anything on the vehicle without a written manufacturer's approval. Your vehicles guarantee terms do not cover unapproved modifications.
- The spare parts must meet the technical requirements set forth by the manufacturer company. Only the original spare part/parts meet their requirements.

Danger Source	Consequences
<p><b>Contact with load during loading, unloading or cleaning</b></p>	<p>Risk of injury or poisoning!</p> <p>Breathing load or contact with skin or eyes may result in injury.</p> <ul style="list-style-type: none"> <li>• <b>Avoid physical contact with load and avoid breathing vapour resulted from load.</b></li> <li>• <b>Never loosen connection hoses during loading or unloading.</b></li> </ul>

	<ul style="list-style-type: none"> <li>• <b>Wear protective clothes against load and hazards that may arise from load.</b></li> <li>• <b>If the load causes an injury, contact to material safety document for necessary emergency measures.</b></li> </ul>
<b>Rubbing of load against tank walls and connections</b>	<p><b>Risk of fire and explosion!</b></p> <p>If the identical potential conductor (grounding pins) is not connected, statical load may cause sparks and explosions.</p> <ul style="list-style-type: none"> <li>• <b>Connect grounding pins during loading, unloading and cleaning.</b></li> </ul>
<b>Entering into the tank</b>	<p><b>Risk of fatal injury!</b></p> <p>Entering into the tank after the journey for cleaning, inspection and maintenance purposes will lead to serious health risks.</p> <ul style="list-style-type: none"> <li>• <b>Do not enter into the tank when not necessary.</b></li> <li>• <b>Conduct the necessary gas measurements appropriately before entering into the tank.</b></li> </ul>

### 1.6. Danger Areas

In this section, dangerous areas on and around the tanker vehicle and dangers that may occur are briefly described.

<b>Danger Area</b>	<b>Aciton to be performed</b>
<b>Between the tractor and tanker vehicle</b>	<p>Risk of sticking persons during fastening or unfastening tractor and tanker vehicle.</p> <ul style="list-style-type: none"> <li>• <b>People should be far off from the danger area.</b></li> </ul>

<p><b>Around tanker vehicle</b></p>	<p>Presenting unauthorized persons around the vehicle during loading and unloading is dangerous for you and other persons.</p> <ul style="list-style-type: none"> <li>• <b>Ensure the unauthorized persons are outside the danger area.</b></li> </ul>
<p><b>All sides of not connected tanker vehicle</b></p>	<p>In some cases not connected tanker can suddenly fall down and injure people.</p> <ul style="list-style-type: none"> <li>• <b>For this reason never stay around the tanker not connected to tractor.</b></li> <li>• <b>Tanker should be in safe condition for maintenance operations.</b></li> </ul>

### **1.7. Weather Conditions**

Depending on weather conditions, make sure the vehicle is free from snow and ice at temperatures below zero. Clean the snow or ice in the vehicle. Do not put yourself in danger during this process.

## 2. MAIN INFORMATIONS

There are vehicle identification stickers on the vehicle.

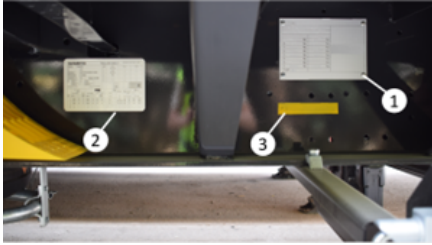

### 2.1. Vehicle Identification Plate

Vehicle identification plate is located on the right side of the vehicle.

You may find the following information's on this plate:

- 1- Type approval number
- 2- VIN number
- 3- Technical total capacity
- 4- Technical king pin capacity
- 5- Technical an axle capacity
- 6- Technical total axle capacity
- 7- Nationally approved total capacity
- 8- Nationally approved king pin capacity
- 9- Nationally approved an axle capacity
- 10- Nationally approved total axle capacity
- 11- Vehicle Type

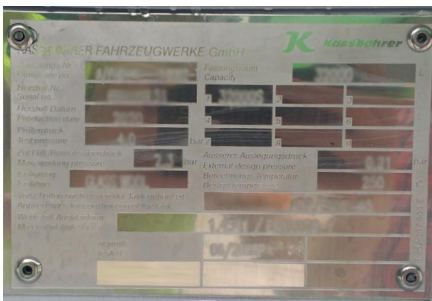

Vehicle identification plate

In addition, since the Stainless Chemical and Bitumen (Tar) tankers are pressurized/non-pressurized vessels carrying dangerous goods, they are in compliance with ADR and the seal of approval by the 3rd organization is on this plate. Tested gross volumes appear on this plate.

### 2.2. Brake Data Plate

There is a brake data plate (2) on the vehicle which is equipped with an EBS system.

You may see this information on this plate.

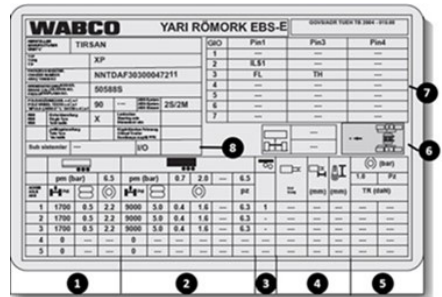

EBS Plate

1	Empty vehicle (without load)
2	Loaded vehicle
3	Axle lifting
4	Brake chamber data's
5	References
6	Driving height
7	Pin positions
8	IN/OUT-Connections

### 2.3. VIN (Chassis) Numbers

The VIN (chassis) number is located on the right side of the vehicle and marked with a different color than the chassis color.



1- Chassis plate

2- VIN Number

3- ADR plate

4- Brake plate

### 2.4. Warranty and Responsibility

Our trailers, semi-trailers and truck on-board applications are manufactured in compliance with regulations and our quality standards. It is necessary to perform the maintenance to ensure our products always operate in the most efficient manner in compliance with our latest directives and maintenance programs. The warranty starting date is

the date that the vehicle is delivered to the customer.

The performance of maintenance and repair/servicing of the vehicle with the use of original spare parts by authorized service shall assure the client's warranty rights. This warranty is based upon the usage and maintenance conditions described herein and in the warranty book. Thus, it is important to read and understand this operation manual and warranty book.

It is necessary to keep the warranty, always operating and maintenance manual available on the vehicle to allow authorized service performing the servicing to see the warranty conditions and maintenance records. In the repairs made during the warranty period, the authorized service performing the repair will demand this. Purchasing one trailer or semi-trailer is an important investment. For the highest return on your investment, it is necessary to comply with the manufacturer's procedures and recommendations during the operation period of the vehicle. The information provided by the client/driver related to the warranty written in this manual shall be kept within our database.

### 3. TRAILER RUNNING GEAR AND USAGE INSTRUCTIONS

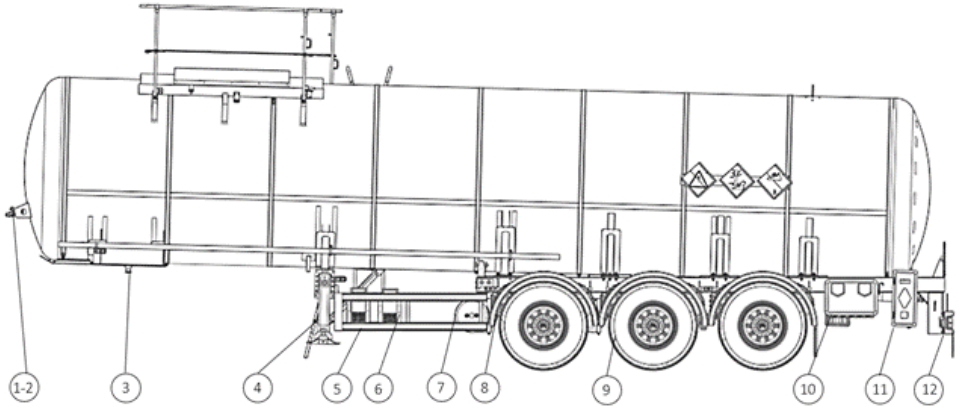

1-2 Brake/Electric Connections

3 King Pin

4 Landing Legs

5 Side Protection

6 Wheel Chocks

7 Air Tank

8 Mudguard

9 Tire

10 Toolbox

11 Fire Extinguisher Box

12 Bumper

#### 3.1. Brake System

##### 3.1.1. Air Couplings

The main connection between the truck and trailers is air couplings.

Generally, 3 different types of air couplings are used in the trailers. These 3 types of air couplings have the same function but with different shapes and connections. There are 2 different air supply lines in the system.

Brake Line (Yellow)

Supply Line (Red)

**Service Line:** Pneumatically air hose which will feeds the brake line.

**Supply Line:** Pneumatically air hose which will feeds the air tanks and trailer

According to the type of vehicle, your vehicle can be equipped with one or two different types of air couplings.

- Standard Couplings (Palm)
- Duomatic Coupling
- C (UK) Couplings



If your vehicle is equipped with 2 different types of couplings, you must use only one type at the same time.



When the couplings are mounting/demounting, the parking brake of the truck and trailer must be engaged.



If the brake parameters are modified, your vehicle's brake calculation might be non-suitable for regulations. Only authorized services must service to the EBS modulator.



Only authorized services and personnel should make service operations for the brake system.

There might be test points on the chassis or above the air couplings. When you remove the test points rubber protection parts and push the points you can check the air pressure on the brake lines.



*Test point*



*Palm coupling with a test point*

### 3.1.1.1. Mounting of Standard (Palm) Couplings



*Couplings*

- Slightly slide plastic covers to the upper side. Slide plastic covers to upper side.
- Be sure that sealing surfaces are clean and durable. If necessary, clean/change the air coupling.
- The coupling which comes from the truck should be pushed slightly from the upper side to the lower side and connect the coupling. Be sure that couplings are matched correctly.
- First mount service line yellow (1).
- Mount supply line red (2).

### 3.1.1.2. Demounting of Standard (Palm) Couplings

- The coupling which comes from the truck should be pushed slightly from the lower side to the upper side and demount the coupling.

- First demount the supply line red (2).
- Demount the service line yellow (1).
- Slightly slide plastic covers to the lower side and close the plastic covers.

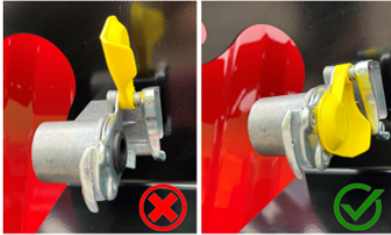

*Closing the coupling*

 **Driving with a non-suitable air connection is dangerous and forbidden.**

 **Using damaged air supply parts can cause serious hazards. Torn or damaged compressed air connectors reduce the vehicle's braking performance.**

### 3.1.1.3. Mounting of C (UK) Couplings

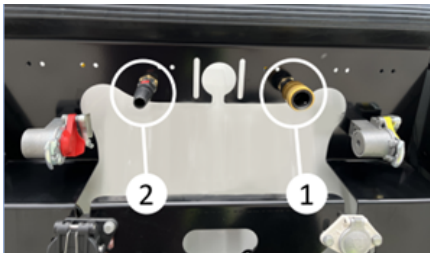

*Mounting the C (UK) Couplings*

- Be sure that sealing surfaces are clean and durable. If necessary, clean/change the air coupling.
- First mount service line yellow (1).
- Mount supply line red (2).

- Be sure that couplings are matched correctly.

### 3.1.1.4. Demounting of C (UK) Couplings

- Push the latch from front to back side on the C couplings and remove.
- First demount the supply line red (2).
- Demount the service line yellow (1).

 **The coupling filters have to be clean regularly.**

### 3.1.1.5. Mounting of Duomatic Coupling



*Duomatic Coupling Connection*

- Be sure that sealing surfaces are clean and durable. If necessary, clean/change the air coupling.
- Push the arm and mount the coupling (1).

 **The coupling filters must be clean regularly.**

### 3.1.1.6. Demounting of Duomatic Coupling

- Push the arm and mount the coupling (1).
- Pull back the arm slightly and close the coupling cover.

### 3.1.2. Compressed Air Tanks

Pressured air can be stored in the air tanks.

The quantities and capacities of the air tanks can be changed according to your vehicle specifications.

In cold periods of the year or when the air humidity is high, the moisture in the air can be condensed and collected in the compressed air tank.

The tractors are generally fitted with air driers to prevent condensation in compressed air. The tractors are generally fitted with air driers to prevent condensation in compressed air. Even if the air driers system, the humidity in the air can be condensed. The condensed water must be drained out via the drain valve.

The water in the air tanks should be completely drained out. That's why please push the valve on the air tanks.





1. Compressed Air Tanks

2. Drain valve

 The water in the compressed air tank can cause corrosion problems and affect the functionality of the brake system. The frozen water in the pneumatic lines can cause the failure of the brake system.

 The water in the pneumatic system should be checked more frequently in cold weather or extremely variable outside temperatures.

 When the air tank pressure is lower than 4,5 bars, the EBS warning lamp on the tractor turns on and the driver can see this situation.

 When the pressure in the service line (in the red coupling) is lower than 2,5 bars, the brakes automatically lock.

### 3.1.3. EBS Socket



*EBS Socket*

Our trailers and semi-trailers are equipped with an EBS system.

EBS is an electronically controlled brake system, that is fitted with automatic load sensing braking pressure regulation (ALB) and automatic anti-skid systems (ABS/ABV).

To activate the EBS system, your truck and trailer must be equipped with an EBS system. Please mount the EBS cable that will come from the truck to the EBS socket on the trailer.

- Driving with a non-connected EBS connection is illegal.
- Drive only with an approved and well-operating EBS plug connection in accordance with regulations.
- EBS connection must be made between the truck and trailer.
- When the EBS socket mounted and truck engine is activated, you will hear the noise. Please listen and check carefully.
- A system control is performed two seconds after the trailer EBS is switched on; in the meantime, the magnets may be opened and closed audibly for a short time. When plugging the EBS connector, if you cannot hear the system control, a power supply problem exists between the tractor and EBS.

When the truck engine is activated and during the travel, the EBS system will be checked automatically. If the truck screen is suitable/adjusted, the EBS failures will be shown with the EBS mistake lamp.

The EBS mistake lamp on the truck screen will be turned on when the ignition key is activated. If there is no failure on the EBS system, the lamp will be turned off in appr. 2 seconds.

After 7 km/hour speed, if there is a failure on the EBS system (Sensor mistake and etc.) EBS lamps will be flashed.

If the EBS lamp is activated, please contact with authorized services immediately.

 **The trailers equipped with a Trailer EBS E braking system may only be used with tractors with:**

ISO 7638-1996 connectors (ABS + CAN) or ISO 7638, 7 pin with CAN data line (EBS Truck)

 **If you drive without EBS connectors or if there is a problem on the EBS system, the brake system will not be worked properly. This situation may cause an accident.**

 **Trailers are equipped with an additional power supply for the EBS system. Thanks to the extra power supply from brake lamps, when the EBS connector is damaged, an extra safety function will be activated. The EBS system will be fed from brake lamps and ALB (automatic load sensing braking pressure) and ABV (anti-skid system) functions will be activated.**

**3.1.4. Rollover Stability Support (RSS)**

Rollover stability support (RSS) is integrated into the trailer modulator. The vehicle's electronic control unit analyzes wheel speed, load information and transverse acceleration data to detect the likelihood of vehicle roll-over before the driver realizes there is a risk and automatically applies the brakes. But don't forget that this system cannot cancel the laws of physics.

When the roll-over risk is detected, the EBS system makes automatically brakes and tries to reduce the roll-over risk. After risk, the RSS function will be shut down automatically.

 **The RSS optimizes driving characteristics and in emergencies may help to prevent accidents. But cannot completely guarantee.**

**3.1.5. PREV (Park Release Emergency Valve)**

Generally, brake control systems will be located on the driver's side. It may be different on your vehicle according to the vehicle's construction.

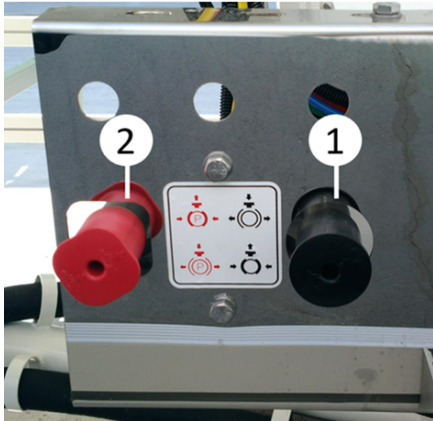

PREV Buttons

**Black button (1):** Service brake button.

**Red button (2):** Park brake button



**When you are driving the trailers, the red button must be pushed position and the black button has to be pulled position.**

### 3.1.5.1. Service Brake

Thanks to the service brake, the trailer can be made maneuvers without air connections. The black button can be used only without air connections on the trailer.

When you push the black button, the service brake will be disabled. When you pull the black button, the service brake will be activated.



**If the service brake is used a lot of times, without an air connection, air pressure in the system and braking power may reduce.**

When the air connections are de-mounted, the service brake will be automatically activated. When the air connections are mounted, the service brake will be automatically disabled.



**The service brake is not suitable for braking of the semi-trailer permanently. During longer waiting periods, the semi-trailer must be secured with a spring-loaded park brake and with wheel chocks.**

### 3.1.5.2. Spring Loaded Park Brake

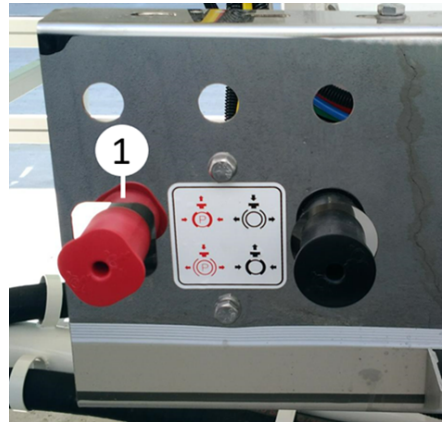

Spring loaded park brake

Spring loaded park brake control button is used for longer parks of semi-trailers with or without tractor on plain or inclined lands.

When the red button is pulled, spring loaded park brake will be activated. When the operator pushes the red button, spring loaded park brake is deactivated.



**This brake will not be deactivated automatically. Before driving, the operator must deactivate the brake.**

### 3.1.6. Brake Chambers

Your vehicle may be equipped with disc or drum brake axles according to your choice. For both brake types, the brake chambers are going to use for braking. The brake chambers will be chosen according to axles type and loading capacity. The maintenance, modification or repair operations must be performed by authorized services.

### 3.1.6.1. Manually Deactivation of Parking Brake Spring

The Parking brake spring may be deactivated manually in emergency situations.

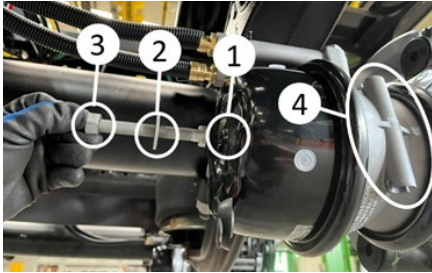

*Deactivation of brake chambers*

1. Boreholes
2. Release rod
3. Nut
4. Slot of the release rod

- Remove the release rod (2) from the slot (4).
- Insert the release rod (2) to boreholes (1) and screw till the rod (2) will be fitted completely.
- Completely screw in the nut (3) to the release rod (2).

The brake chambers will be deactivated after this operation. In this case, the brake chamber only works on the service brakes. Even if the trailer air tube pressure drops below 2.5 Bar, the spring brake will not be activated due to this operation.

On some brake chambers used in vehicles, the emergency release screw is located in its socket (1) behind the brake chamber, not in its socket (4) next to it. In order to disable the springs, it is allowed to come out by simply turning it with the appropriate key.

 This operation should only be used until the trailer is serviced.

 Before this operation, the vehicle must fixed securely with wheel chocks. Serious injuries may occur.

### 3.1.6.2. Activation of Brake Chambers

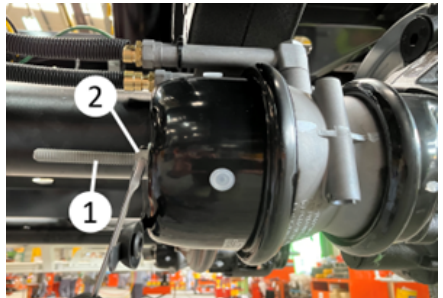

*Activation of brake chambers*

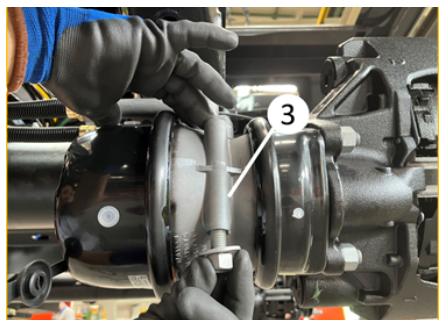

- Remove the nut (1) from release rod (2) with a spanner.
- Remove the release rod (2).
- Screw the release rod into its place on the brake chambers (3)

- Close the plastic cover on the brake chamber.

Brake chamber will be activated after this operation.

 **Before this operation, the vehicle must be fixed securely with wheel chocks. Serious injuries may occur.**

 **Don't drive without being sure that all the brake system is working properly after this operation**

### 3.2. Suspension System

Your vehicle is equipped with air suspension system.

 **When entering uneven or damaged roads, the fifth-wheel plate height and the trailer should be raised. Otherwise, the front part of the trailer may come into contact with the tractor, or trailer components may be damaged. While raising the vehicle, check the external height and make sure it does not hit anything. Comply with legal height limits. Once the problematic area has been passed, the vehicle should be returned to driving height.**

#### 3.2.1. Manuel Control

You may choose the fifth Wheel height with a control button which is located at the driver side.

When you set the button in position 1, you may use your semi-trailer in a lower fifth wheel height and when you set the button in position 2, you may use your semi-trailer in a higher fifth wheel height.

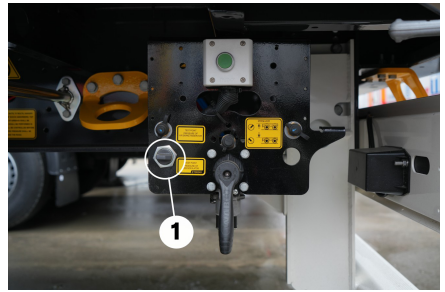

*Lower driving height*

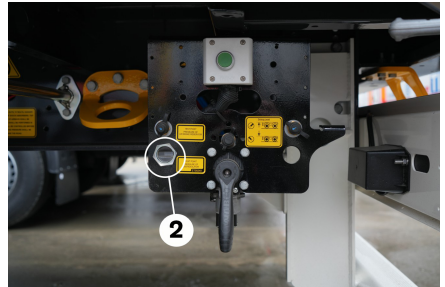

*Higher driving height*

#### 3.2.2. Auto Reset

The auto reset lever can be controlled by the same method as 3.2.1. manual suspension control lever. When the EBS socket is mounted and driving at a speed defined by the producer, the lever will set the driving height automatically.



*Automatic driving height position*

### 3.2.3. Electronic Controlled Air Suspension (ECAS)

Electronic controller air suspension (ECAS) is an optional solution. This system sets the driving height or defined different heights electronically. When the EBS socket is mounted and driving at a speed defined by the producer, the lever will set the driving height automatically.

You may push the lower or raise button and set the vehicle height.



ECAS control panel

### 3.3. Electrical System

15 pin, 2x7 pin (For tankers without ADR) or 15 pin +2x7 pin (For tankers with ADR) electrical sockets are option in our vehicles. Thanks to these sockets, electrical connections between truck and trailer will be made.

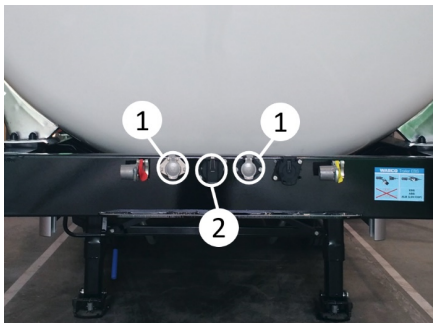

Electrical system

 When driving, the electrical sockets between the truck and trailer must be connected.

 Please be sure that the truck and trailer are suitable for the norms/standard about electrical systems. Otherwise, electrical problems will occur.

#### 3.3.1. 15 Pin Socket

This system provides electricity for the electrical system on the vehicle like stop lamps, signal lamps etc. 15 pin socket connections are made according to ISO 12098.

Open the protection cover and mount the sockets regularly.

You may find extra information about the pins function in below.

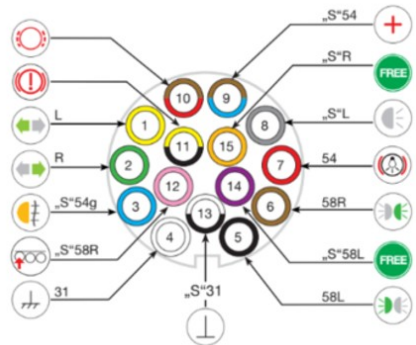

Pin	Meaning
1	Left indicator
2	Right indicator

3	Fog lamp
4	Ground
5	Left taillight
6	Right taillight
7	Brake light
8	Reverse light
9	Supply line
10	Brake Lining Wear
11	Traction Lowering help/Force
12	Axle Lift
13	Chassis Electronics
14	Empty
15	Empty



ISO3731 Soket

Pin	Meaning
1	Ground
2	Empty
3	Reversing lamp
4	Supply line
5	Empty
6	Axle Lift
7	Fog lamps

### 3.3.2. 2x7 Pin Socket

This system provides electricity for the electrical system on the vehicle like stop lamps, signal lamps etc. 2x7 pin socket pin connections are made suitable for 24S ISO 3731 and 24N ISO 1185 norm.

Open the protection cover and mount the sockets regularly.

You may find extra information about the pins function in below.

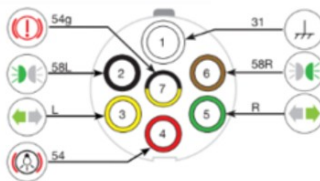

ISO 1185 Soket

Pin	Meaning
1	Ground
2	Left taillight
3	Left indicator
4	Brake light
5	Right indicator
6	Right taillight
7	EBS

**Please be careful with the color of the sockets. The black socket is suitable for ISO 1185 and the white socket is suitable for ISO 3731. If the vehicles are suitable for norms, the black socket on the truck will be connected to the black socket on the trailer and the white socket on the truck will be connected to the white socket on the trailer.**



### 3.3.3. Light System

The vehicle is equipped with a light system which is suitable for the regulations.

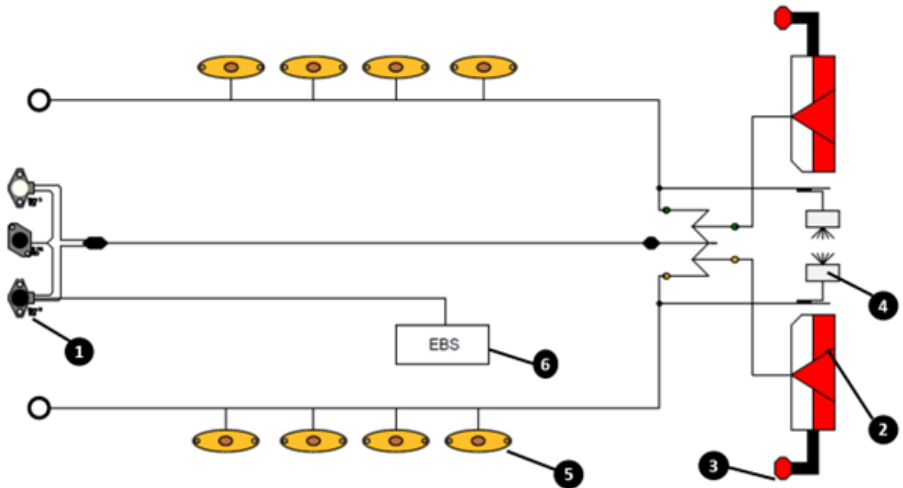



1	Electrical Sockets
2	Stop Lamps
3	End Outline Markers
4	License Plate Lamps

5	Side Position Lamp
6	Modulator

The lamps must be checked regularly. If there is any problem with the electrical system, it must be repaired immediately. In a repair operations, only original and approved sockets or parts must be used.

 If you add or remove any lamps on the vehicle, your vehicle may be non-suitable for regulations.

 Vehicles with LED electrical systems consume very low energy. For this reason, although there is no problem in the system, it may cause the failure lamp to come on in old tractors.

 Repairing operations of the electrical system have to be made by only authorized services. Otherwise, electrical problems may occur or your vehicle may be out of warranty.

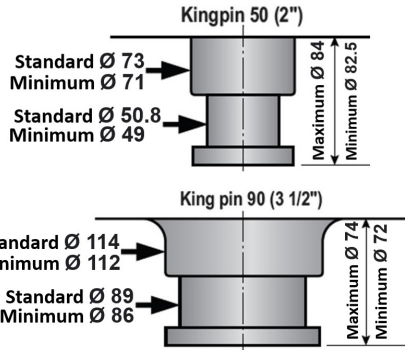

 If you match the truck and trailer with a different diameter king pin, injuries may occur.

The flanged king pin is used on the vehicle. That's why king pin can be replaced easily.

### 3.4. King Pin

King pin is a shaft which connects truck and railer together. Your vehicle may be equipped with 2" or 3.5" diameter pins. Please check the king pin diameter before connecting the truck.



Kingpin

 If the wearing on the king pin is bigger than 2 mm, the king pin must be replaced.

Your vehicle may be equipped with a double king pin slot. You can remove the bolts around the king pin and mount king

pin to the other slot. Please be careful about the total length of the vehicle according to country regulations and be sure that the total length is suitable for regulations.

### 3.5. Landing Gear

There is a front landing gear behind the vehicle's gooseneck area so that your vehicle can stop in park without truck.

#### 3.5.1. Front Landing Gear's Working Principle

The landing gear crank handle (1) should be removed from its holder (2) and brought to a perpendicular position to the vehicle.

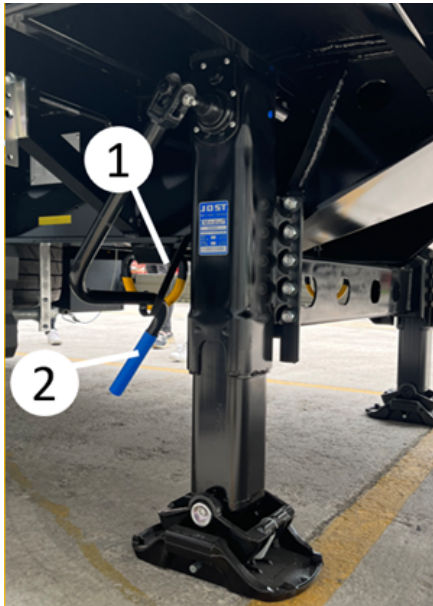

*Landing Gear*

**Low Speed (A):** When the crank handle (1) is turned in the fully pressed position, it raises / lowers at low speed.

**High Speed (B):** It performs high speed lifting / lowering when the lever turned in the fully extended position. The position is used to quickly lower the gear until the foot (plates) touch the ground during the process of separating the semi-trailer from the tractor, or to raise the gear

quickly after the semi-trailer is connected to the tractor.



The landing gear crank handle is usually located on the passenger side of the vehicle.

 In all conditions, secure the semi-trailer against tipping with correctly positioned wheel wedges. If the vehicle is not properly secured, the landing gear or the vehicle may be damaged.

 If the loading / unloading operation is performed while semi-trailer is not paired with the tractor, the front or rear of the vehicle may raise. Serious accident and damaged may occur. For this reason, the semi-trailer must be paired with the tractor during the loading and unloading operations.

 If the tractor leaves from the loaded trailer, be sure that the load is distributed homogeneously in the vehicle. Otherwise, the front or rear section of the vehicle may be raised due to centre of gravity, and accident may occur.

In order to protect the landing gear, be sure that there won't be any lateral movements on your vehicle. For this reason give attention to the following criteria:

- Disconnect the semi-trailer from the tractor only when the landing gear are in the middle (neutral) position.
- If you will park for a long time without the coupled tractor, be sure that air suspensions are lowered and after that adjust the landing gears. Thus, the loading area will be parallel to the ground.



Landing gear view

Optionally, an aluminum landing gear can be supplied.

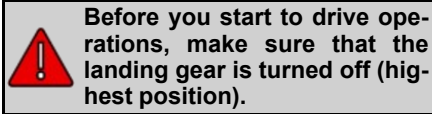

### 3.6. Side Protection Equipment (Underrun Protection)

The side protection equipment must be in the off position while driving. Some side protection equipment can be opened upwards to facilitate service operations such as accessing the spare tire.

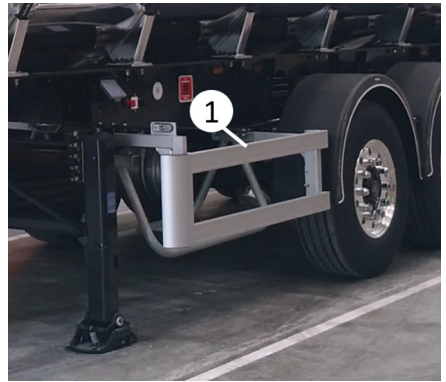

Underrun protection

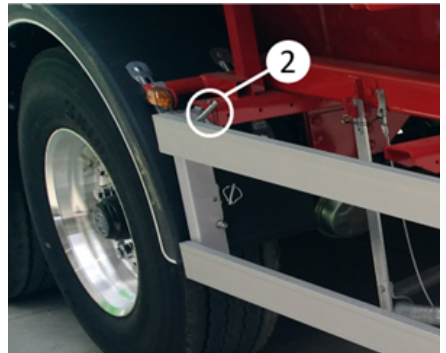
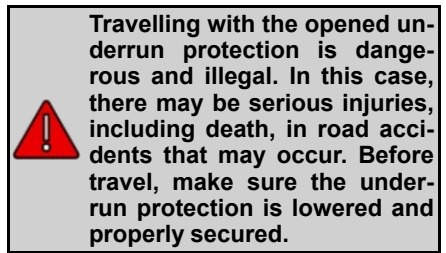

Pin

**Removing Underrun Protection:** After opening the protection release pins (2) on both sides, the underrun protection is removed and taken out.

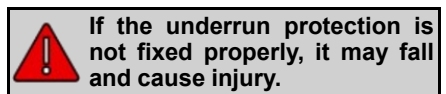

**Installing Underrun Protection:** Insert the protection into its slot from both sides and insert the pins.

### 3.7. Semi-Trailer Axle System

Axle with disc or drum type brake mechanism are used in your vehicles.

Semi-trailer axles may only be loaded with the maximum legally permissible axle load indicated on the vehicle identification plate. The user is responsible for use of the trailer in accordance with its purpose and capacity and for its maintenance.

The healthy operation of the brake system of the semi-trailer depends on the usage of the semi-trailer with the same system and/or compatible tractor. For this reason, it is obligatory for the buyer to make the brake adjustment at the authorized service of the tractor company to which these semi-trailer/trailers are to be matched. If you use the unadjusted truck-trailer combination, the producer doesn't take any responsibility for the damage/failure that may occur in the brake system or vehicles. All responsibility belongs to the customer.



**For more information about the axles, please check the axle's user manual which was delivered with your vehicle.**



**If the axles are used other than the conditions specified in the manufacturer's manual or if their maintenance is not made properly, your vehicle may be out of warranty.**



**If the vehicle is equipped with emergency brake chambers, apply the parking brake after checking the drum temperature. Never use the parking brake when the drums are very hot (the drum may crack).**

#### 3.7.1. Self-Steering Axles

Your vehicle may be equipped with a self-steering axle to increase the maneuverability capacity during forwarding driving. This type of axle is usually positioned at the rear axle of the vehicle and has a locking mechanism.



**The turning radius of the vehicle which is equipped with a self-steering axle is different from standard vehicles. In addition, there will be differences in the maneuverability of the vehicle in cases where the self-steering axle is locked or unlocked. Please be careful about the self-steering axles.**

##### 3.7.1.1. Locking The Steering Axle

For vehicles with Electronic Braking System (EBS), the self-steering axle can be locked automatically when the reverse gear is engaged in order to reverse. It is also possible to lock this axle manually.

Drive the vehicle straight ahead so that the steering axle is in a straight position before the steering axles will be locked.

If the automatic axle locking function is active in your vehicle, the steering axle will be locked automatically when you engage reversing gear.

If you want to lock axles manually, make sure that the steering axle is in a straight position and close the valve (1) or turn the button to the off position.

The locking valve will be positioned towards you when the self-steering axle is locked manually.



**Reversing with unlocked steering axles is dangerous. The semi-trailer can be separated from the tractor. Before going backwards be sure that self-steering axle is locked.**

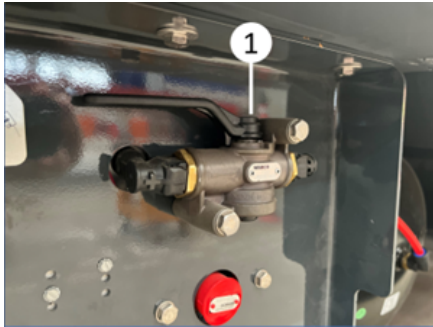

*Self-Steering Axle Release Valve*

### 3.7.1.2. Unlocking The Self-Steering Axle

The self-steering axles, which lock automatically when reverse gear is engaged, will automatically unlock when the vehicle is moving forward.

To release the manually locked self-steering axle, turn the valve handle 90° (2) clockwise or move the button to the open position.



**When the self-steering axle is locked manually, the axle will not be unlocked automatically. It must be unlocked manually.**



*The Self Steering Axles Release Valve*

### 3.7.2. Axle Lifting

Axle lifting feature is optionally available in different quantities and location in your vehicle. Thanks to this feature tire wear is minimized and a more balanced load distribution on the tractor can be achieved. The EBS connection must be active for the axle lift load to work.

Axle lifting feature is controlled automatically due to the legal regulations. When the speed limit exceeded while the EBS is active, some axles can be lifted automatically if the load on the axles is less than the maximum allowable axle load.

It may be necessary for the operator to manually intervene the axle lift with a departure help aid or maneuvering aid.



**In order for the departure aid to be activated (raising the axle) , the vehicle must be slower than 30 km/h and the technical capacity of the axles must not exceed 30%.**

When the vehicle is stationary, it is possible to activate the traction help by pressing the tractor brake pedal 3 times in a row.

If your vehicle have optional axle lifting feature from tractor cabin, it is possible to manually lower/ raise the axle lift with a spring load-ed button to be installed in the tractor cabin. Fort his feature, your tractor must be adjusted according to the tractor.

It is also possible to activate /deactivate the axle lift with the help of the button on the trailer. Driving assistance can be activated by pressing and holding this button for less than 5 seconds. If it is pressed more than 5 seconds, the axle can be lowered to the ground.

You can also find information on how to use the axle lift control on the driving aid sticker on your vehicle.



As a result of intervention in the axle lift parameters, your vehicle may be out of regulation. For this reason, the EBS modulator should not be interfered with except authorized services.



*Axle lifting device*

- 1- ECAS Control box
- 2- Joystick
- 3- Axle lifting / lowering



*Axle lifting*



**There is a danger of being pinched and injured when lowering /raising the axle.**

### 3.7.3. Hubodometer

Hubodometers show the distance traveled by the vehicle in kilometers or miles.

The unit of the hubodometer is written on the hubodometer. It is adjusted according to the tire diameter.



*Analog Hubodometer*



*Digital Hubodometer*

### 3.8. Tires

During the selection of semi-trailers tires, it should be ensured that the tire has appropriate carrying capacity.

The manufacturer offers tires suitable for a variety of uses, such as high way use, off-road or mixed use. Among the tires suitable for your intended use, according to EU tire label values, tire with a low decibel value and as close to Class A as possible should be preferred for breaking ability and fuel efficiency on wet roads.



**You can access the EU tire label values of the tire used in your vehicle on our website.**

On vehicles with double/ twin row wheels, tires must be properly matched according to their diameter. The tread depths of side-by-side tires should not differ more than 5 mm. In addition, depending on the structure and type of the vehicle, newly coated tires and partially worn tires should not be used side by side. Otherwise driving safety disappears. Although the tread depths appear to be the same in this type of tires, it should be concluded that the tire radii are different and tires with radii differences exceeding 10 mm should not be used side by side.

Mismatching results in the larger tire being excessively deformed by carrying too much load. In this case, wear accelerates, creating the danger of premature tire wear. This should also be considered when radial and crossply tires are used side by side.



*Tires*



**In some countries, seasonal use of M+S (Mud and Snow) or 3PMSF (3 Peak Snowflake) may be mandatory. In the country of driving, this etc. Tire regulations must be observed.**



*M+S and 3PMSF symbol*



**Very serious accidents can occur if unsuitable or worn tires are used.**

### **3.9. Spare Wheel Holder**

Different type of spare wheel holders is optionally offered in our vehicles.



**Make sure that you put the necessary warning signs and take the safety precautions during the tire change.**



**Driving with insufficiently secured spare tire (s) can occur accidents.**



**The tires are heavy parts. Be careful about ergonomics and occupational health and safety rules during the tire replacement. There is a risk of pinching, falling, and cutting.**



**Spare wheel holder carriers are designed for special tires dimensions. Follow the rules and regulations when removing/mounting or maintaining the spare tire or spare wheel holder.**

### 3.9.1. Crane Type Spare Wheel Holder

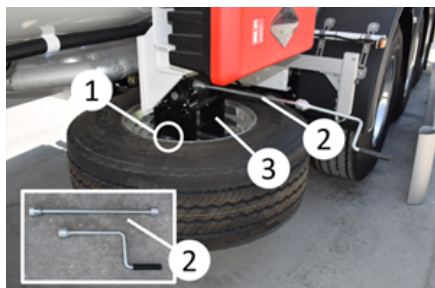

*Crane type spare wheel holder*

#### Removing the spare wheel:

- Remove the screws (2).
- Mount the lever (3) and turn it counterclockwise slowly. The spare wheel will be lowered.
- Remove the fixation parts (4) and take the spare wheel.

#### Placing the spare wheel:

- Mount the fixation parts (4) to the tire.

- Lift the tire upwards by turning the handwheel (3) clockwise.
- Turn the lever (3) clockwise and the tire will be lifted.
- Mount the screws (2) and fix the tire.
- Remove the lever (3) and store in the toolbox or cabinet.

### 3.9.2. Basket Type Spare Wheel Holder

Single or double basket type spare wheel holders may be optionally provided. Both spare wheel holder working instructions are similar.

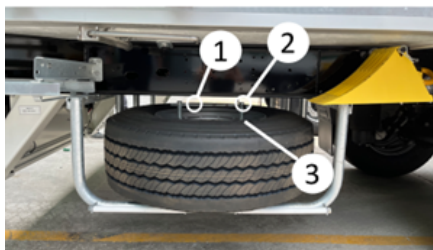

#### Removing the spare wheel:

- The pin (2) should be removed on the fixation cane (1).
- The fixation cane (1) and the pin (3) will be removed.
- The tire should be slightly moved towards outside of the vehicle.

#### Placing the spare wheel:

- The tire will be slid slightly into spare wheel holder.
- The fixation cane (1) and pin (3) will be attached.
- The pin (2) will be mounted.

### 3.10. Mudguards

Your vehicle has mudguards and mats in accordance with legal regulations. This equipment prevents water and similar

substances on the ground from splashing onto other vehicles.

Some vehicles may have folding mats to prevent the mat from rubbing against the ground in the event of a crash.





*Mudguards*

 **Folding mats must be in the open position while driving.**

### 3.11. Wheel Chock

There are two units wheel chocks and holders in the vehicle.

 **The vehicle must be secured with wheel chocks when parked on a slope area, during the loading and unloading operations or when parked without a tractor.**

 **Only place wheel chocks on wheels on fixed axles, never on idle/steer axles.**

 **When the wheel chocks is fixed inside the holder, be sure that the pins will be mounted properly.**

 **After driving operations, place the wheel chocks properly.**

#### 3.11.1. Pin Type Wheel Chock Holder

**Removing The Wheel Chock from Its Seat:** Pull out the cotter pin (1) located at the end of the pin type wheel chock holder. Then take the chock from its slot by pulling it sideways from the chock holder.



*Pin type wheel chock holder*

**Placing The Wheel Chock from Its Seat:** After use, fit the chock onto the chock holder pin and fix it by replacing the cotter pin.

### 3.11.2. Pocket Type Wheel Check Holder

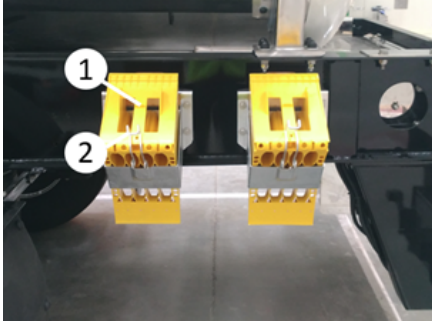

Pocket Type Wheel Chock Holder

**Removing The Wheel Chock from Its Seat:** Remove the wheel chock by pushing the handle (1) located at the end of the chock holder from the wheel chock to the other side.

**Placing The Wheel Chock from Its Seat:** Insert the wheel chock by pulling the handle (1) located at the end of the chock holder.





Toolbox



Opening the lock

### 3.12. Boxes and Storage Units

 Be sure that the boxes and storage units are properly closed and that the materials inside of these storage units are fixed properly before driving. Otherwise, the accident may occur.

 Be sure that the necessary safety measurements are taken while using the cabinets and storage units.

#### 3.12.1. Stainless Steel Toolbox

It is used to store tools and tools. It is usually mounted on the driver's side of the vehicle.

#### Opening the lock:

- Insert the key into the lock and turn it to the unlocked position.
- Pull the lock lever back and open the cover by turning it.

#### 3.12.2. Steel Food Box

This type of toolboxes is usually positioned on the passenger side. There might be some compartments and gas cylinders for compartment for cooking.



Steel Food Box

### Unlocking the Food box:

- Insert the key into the lock and switch it to the unlocked position.
- Pull the lock arm back and open the cover by turning it.



*Steel food box*

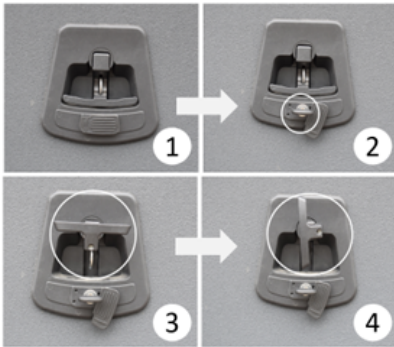

*Unlocking steel food box*

**i Some boxes may have a sliding shelf. You can pull the sliding shelf towards you by opening the locking mechanism of the sliding shelf. After the sliding shelf is closed, it must be locked.**

### Lamps:

The box might be equipped with lamps. These lamps are connected to the parking lamps. When the parking lamps are on, you may push the on/off switch and turn on or turn off the lamps.

### 3.12.3. Plastic Toolbox



*Plastic toolbox*



*Plastic toolbox*

### Unlocking The Toolbox:

- Remove the lock cover.
- Unlock by turning the key.
- Pull the lever towards you.
- Turn the lever and open the cabinet door.

### 3.12.4. Fire Extinguisher Cabinet

Fire extinguisher cabinets are used to protect fire extinguishers from the external environment.



**Fire extinguishers should be maintained regularly, and their expiration dates should be observed.**



*Fire extinguisher cabinet*

### **Opening The Cover:**

- Open the 2 plastic latches (1) holding the cover.
- Lift the latch up and back and unlatch the cover to open it.
- Open the Velcro fastening the fire extinguisher and take the fire extinguisher.

### **Closing The Cover:**

- Insert the fire extinguisher and fix it with Velcro.
- Close the cover first and close the latch to the top of the cover.
- Lock the latch to tighten the cover.

### **3.12.5. Water Tank**

The vehicle may have a water tank for general cleaning. You can turn the water on by turning the faucet handle. You can fill the water with the help of the filler neck on the top of the tank.

There may be a soap dispenser on the water tank. You can remove the soap dispenser or fill the soap dispenser by turning it counterclockwise.



**Ignoring hygienic rules and regulations is dangerous for health. Wastewater must be disposed of in accordance with the regulations of the country of residence.**



**The water in the water tank should not be drunk. It should be used for cleaning purposes only.**



**In cold weather, the water tank should be emptied. Otherwise, freezing water may cause the water tank to freeze and crack.**



*Water tank*

### 3.12.6. Document Box

You may store your non-valuable documentation in the round or square type document box.

You can turn the cover of the round type document box counterclockwise and open the document box.

You may lift the pin of the square type document box and remove the pin. The cover of the square type document box may be opened.



**Keep the locking pin and the document box door neatly.**

### 3.12.7. Fuel Tank

A diesel tank in various volumes such as 60-80 liters, which supplies the heater unit, is optionally offered in your vehicle. The filler neck is usually located on the left side of the vehicle. After the fuel tank cap is unlocked, you can open the fuel tank cap by turning it counterclockwise.

In cases where the heater or the fuel tank is installed by the customer, there may be two red and black hoses on the front panel of the vehicle. These hoses are placed to make the heater unit - fuel tank connections. These connections should be made at fuel tank or heater unit services.



**It is necessary to pay attention to the legal regulations during the use of the fuel tank. In case of leakage, you should act in accordance with the legislation of the country you are in.**

### 3.12.8. Armature Box

The armature box is a cabinet containing filling-discharging couplings, filling controls, additional operating controls as well as some hoses and accessories. Filling-discharging operations of the tank are carried out thanks to the equipments in this cabinet. Filling-discharging can be done automatically by means of the controls inside this cabinet. The elements

inside and on the cabinet are explained below:

1. Armature box cover
2. Butterfly valve and dust covers
3. Parking brake activation sensor
4. Discharge adapter
5. 'Ex-proof' lamp for lighting inside the box and on-off power switch.
6. Bucket, shovel and copper hammer

### 3.12.9. Armature Box Cover

This cover is bus type cover. It opens upwards.

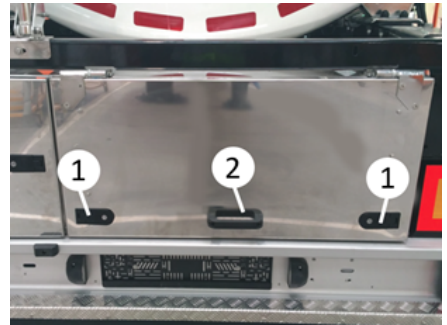

*Armature box cover*

#### Opening the box:

- Insert the key and turn it to open the locks.
- After unlocking pull the buttons (1) on the lock handles.
- With pressing the button, the lock handle gets out.
- After lock handles have got out, lift the box cover by the handles (2) on both sides.

#### Closing the box:

- Lower the cover and place into the lock.
- Pull the lock handle forward and lock it.

- At last lock the cover with key.

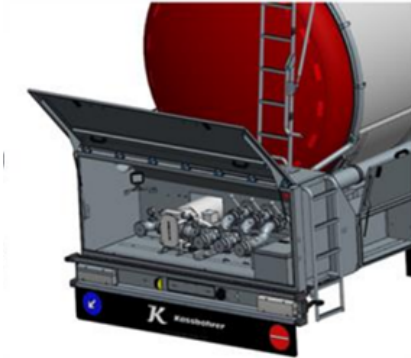

*Armature box*

### 3.12.10. Hose Carriers and Hose Holders

The hose carriers (1) are mounted on one or both sides of the vehicle, singly or in pairs, on the upper part of the chassis in order to carry the discharge hoses. It may vary in size. Optionally, the cover can be placed on the front or both front and back. Door keys are kept in the tool box.

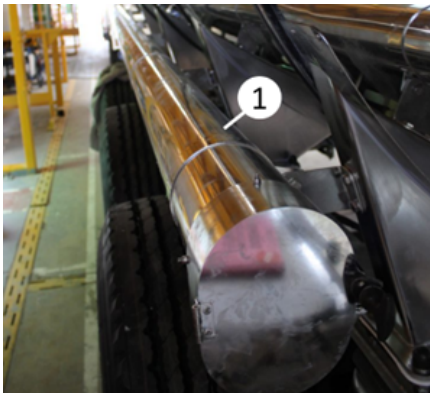

*Hose carrier*

The hose holder is available for bitumen tankers (2). The upper part is open, in the form of a pool. Hoses are carried by putting in it. There is a drain hole at the rear end to prevent liquid from accumulating inside.



*Hose holder*

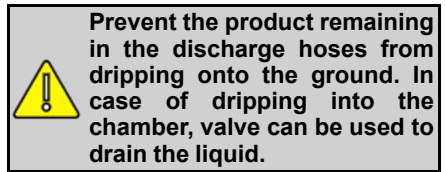
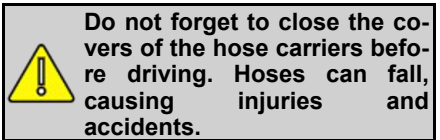

### 3.12.11. Working Lamp

It is located at the rear of the vehicle, mounted on the top of the bumper or on the chassis profile (1). Its location may vary depending on the construction of the vehicle and the customer's request. It is located at the rear of the vehicle for use in work after dark. The lamp can be rotated up-down and left-right so that the lamp can be used more comfortably and in a wider area. The lamp can be turned on and off with the switch (2) on the back.



Working lamp



Working lamp switch

### Putting the lamp into use:

Remove the upper arm of the lamp from the lock-latch mechanism by pulling the lamp, then use it by pulling it to the desired area.

### Fixing the lamp in place:

After use, push the lamp into place by folding the foldable arms. Fix the lamp you have pushed into place by locking the lock-latch mechanism.

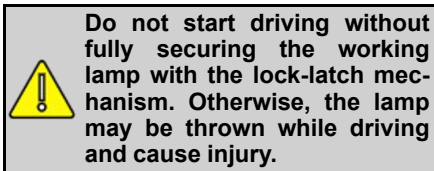
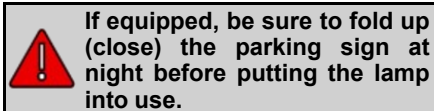

Optionally, the working lamp switch can also be supplied behind the working lamp.

## 3.12.12. Rear Bumper (Rear Protection Equipment)

Your vehicle has a rear bumper (rear protection equipment) in accordance with legal regulations.

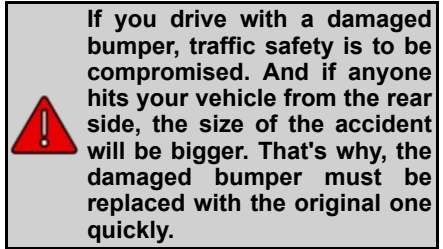

### 3.12.12.1. Fixed Bumper Tanker vehicle bumper

1. Lamp group
2. License plate location
3. License plate lighting
4. Side marker lamps
5. Reflectors

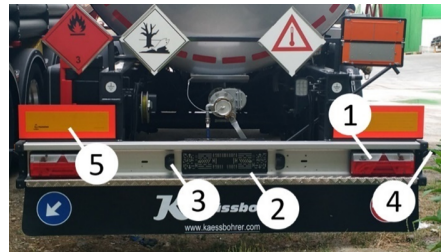

Fixed bumper

## 3.12.13. Ladder, Walkway and Handrails

There are slight differences between the ladder systems on STS, STC and STL tanker vehicles. In chemical (STC) tankers, the ladder is generally placed at the rear of the vehicle (1) and the bottom of the ladder is foldable for convenience and safety.

In food (STL) tankers, the ladder is fixed and placed behind the tank (2). In the bitumen (STS) tanker, on the other hand, since the filling/discharging manhole is

single, the ladder is located on the side of the vehicle for easy access and safety (3).



Ladder

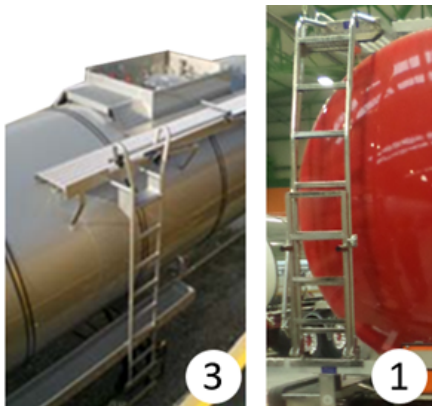

Ladders

### 3.12.13.1. Foldable Ladder

#### Opening the foldable ladder:

Hold the the ladder and release it from the latch-lock mechanism by pulling toward yourself. Open the released ladder by pushing downward.

#### Closing the foldable ladder:

By holding at the lower part of the ladder, lift it upward slowly to prevent the hand-rail drop suddenly. By locking the latch-lock mechanism, which is mounted on

the fix part of the ladder, secure the ladder.



**Do not drive without fully securing the folding ladder with the lock-latch mechanism. Otherwise, the ladder may be thrown while driving and cause injury.**

### 3.12.13.2. Fixed Ladder

The ladder used to climb to the top of the vehicle is manufactured for easiness and safety. In terms of compliance with UVV rules and depending on the customer's request, the front ladder is connected to the upper walkway. In this way, access to the vehicle is provided via a fixed ladder.

### 3.12.13.3. Step Ladder

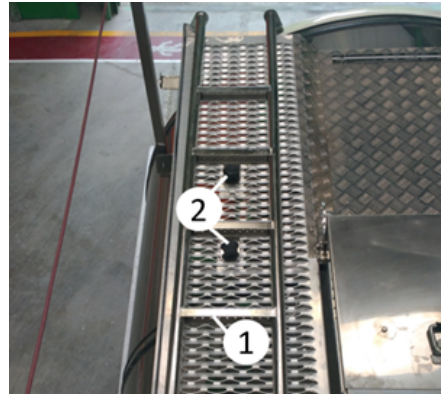

Step ladder

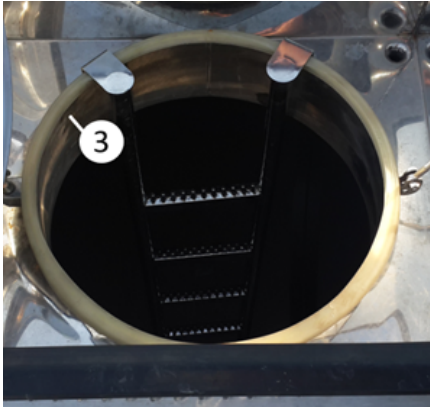

*Manhole neck*

The step ladder (1) is used to enter the tank. It is fixed to the walkway with a plastic nut (2). In cases where it is necessary to enter the tank, unscrew the plastic nut, take the step ladder from its place and hang it on the manhole neck of the compartment to be entered (3). After the process in the compartment is finished, place the step ladder, which is hung on the manhole throat, in its place on the walkway and fix it with a plastic nut.

### **3.12.13.4. Handrail**

It is located at the top of the vehicle on the sides of the walkway. It is necessary for safe work on the vehicle. Our tanker vehicles have handrail systems that open manually, automatically via folding ladders or pneumatic systems.

#### **Opening manual handrail**

Grab the handle (4) on the handrail and pull it towards you and release it from the latch (5) mechanism that fixes the handrail in the closed position. After opening the handrail, make sure that the lock bracket (6), which prevents the handrail from closing by itself, is placed in its slot.

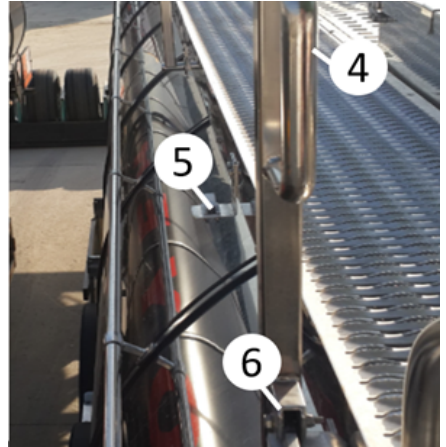

*Opening handrail*

#### **Closing manual handrail**

Lift the locking bracket upwards, grab the handle of the handrail and push it forward. Fix the handrail by putting the handrail's latch mechanism in place.

#### **Opening the handrail through folding ladder:**

Thanks to an arm (2) that provides the connection between the folding ladder (1) and the handrail, the handrail opens when the folding ladder is opened.

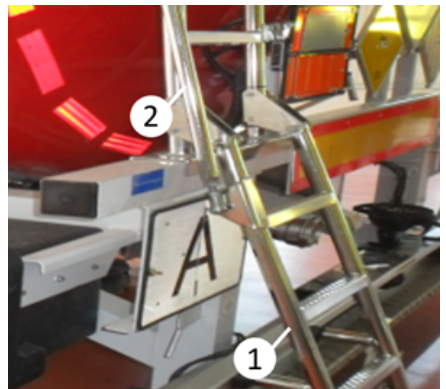

*Folding ladder*

#### **Opening the handrail through pneumatic system:**

The handrail is opened and closed by activating the pneumatic piston (4)

mounted on a bracket (3) connected with the handrail, with the pneumatic control buttons (5,6) positioned on the tank.

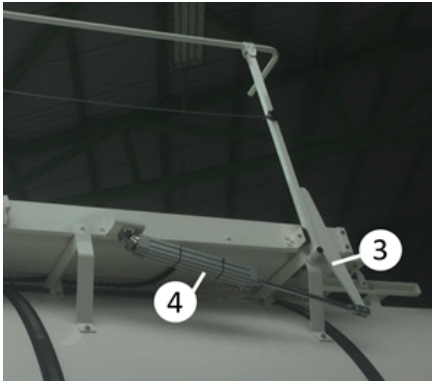

*Pneumatic piston*



*Pneumatic control buttons*

Open the handrail by turning the left handrail pneumatic control button (5), lower the handle to bring the handrail back to closed position.

Turn the right handrail pneumatic control button (6) to open the handrail, lower the handle to bring the handrail back to closed position.

A rope is mounted on the handrail. It is placed in order to prevent the person working on the top from falling.

### 3.12.14. Lubrication System

#### 3.12.14.1. Central Lubrication Automatic Counter System Control Unit

This system ensures that the central lubrication works for 45 seconds when the brake is pressed 100 times.



**Central lubrication system continuous operation time is maximum 25 minutes. The minimum waiting time is 5 minutes.**

### 3.12.15. Grounding Pins

During the filling or discharging processes of the vehicle, there are grounding pins (1) on the vehicle according to DIN 75013 in order to prevent the static electricity charges on the vehicle to be grounded and thus to prevent any fire or explosion. The locations of these pins are indicated by the sign in the figure (2).

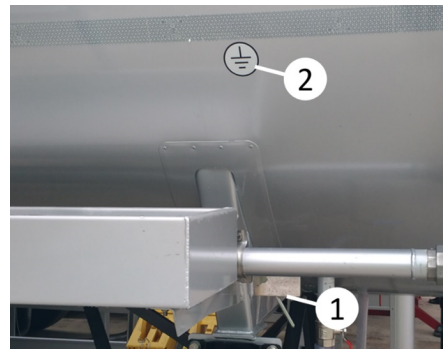

*Grounding pin*

### 3.13. Warning Signs

Warning signs (1) are present on different places of vehicle.



Please pay attention to that warning signs on the vehicle are always visible. Replace worn out, damaged or not visible signs immediately.

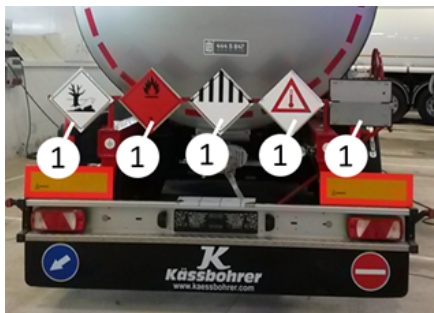

*Warning signs*

## 4. UPPERSTRUCTURE COMPONENTS AND USE

In this chapter, components of upperstructure of the tanker and their use will be explained. It is very important to understand the use and purpose of these components to achieve loading and unloading securely. For this reason, before loading and unloading processes, please read this chapter carefully and follow the instructions.

This chapter starts with an overview of upperstructure components and continues with description of using of these elements in detail. Equipment in stainless steel tankers are described in this chapter.

### 4.1. Bitumen (Tar) Tanker

#### 4.1.1. Overview of Tank Components

Component	Function
Tank	It is the main body with cylindrical structure, manufactured from stainless steel.
Isolation coating	It prevents the transported material from freezing due to heat loss.
Manhole cover	It is used to fill from the top and enter the tank.
Pressure safety valve	It prevents the formation of pressure higher than the operating pressure in the tank.
Vacuum valve	It prevents negative pressure higher than the specified value that may occur in the tank.
Blast valve	In case the pressure in the tank exceeds 3.67 bar, it stabilizes the pressure and secures the tank.
Side air line	Delivers air taken from the compressor to the system.
Jet air line	It accelerates the discharge of the transported product by blowing it at the discharge outlet.
Top air line	It is the line that allows the air coming from the side air line to enter the tank.
Bottom valve	It is located at the bottom outlet of the tank and allows the transported product to be discharged from the tank.
Safety valve	It is the second valve between the bottom valve and the discharge outlet.

Sampling valve	It is used to take samples from the discharge outlet.
Thermometer	Measures temperature of material inside the tank.
Manometer	Measures pressure on the system.
Drain valves	They are used to drain rain water, cleaning water or any water accumulated in the manhole pool.
Heating line	It facilitates the discharge of the product inside the tank, which is welded from the outside to the bottom sheet of the tank, allowing steam or heating liquid to circulate inside, thus heating the product in the tank at the bottom.
Warning signs	It is used to inform other drivers and people about the material in the tank.
Ladder and handrail	It allows the operator to climb onto the vehicle and work safely.

#### 4.1.2. Tank

Tank of the bitumen tanker vehicle is manufactured from steel or stainless steel. Surface of the tank is isolated with fiberglass and coated with aluminium or stainless steel. Generally, tank is manufactured with single compartment since one type of material is transported.

Breakwaters inside the tank prevent floating of material. During sudden brakes or accelerations, they prevent floatings of material and prevent high changes on the center of gravity of the vehicle. Change on the center of gravity of the vehicle may affect road grip and control of the vehicle.

#### 4.1.3. Isolation Coating

Pay attention to walk on the walking way in case walked up to the upper parts of the tank for filling procedure or any other reason. Otherwise the coated surface of the tank can be damaged easily.



**In case of stepping on the tanker, walk on the walkway. Do not step on the plating sheet to avoid damage to the plating sheet on the outer surface of the tank.**



*Bitumen tanker*

#### 4.1.4. Manhole Cover

Manhole is used for filling the tank from top. Vehicle can be filled from top by opening the upper cover, after the vehicle has approached to the station.

Manhole cover is manufactured from stainless steel and is resistant to heat.

### Opening the cover:

- There are hatch clamps (2) on the tank, loosen them by turning the levers.
- After loosening of all clamps, pull clamps backwards and lay on the tank.
- Hold the released cover by the handle (3) present on the cover and rest it on the edge of the spill box.

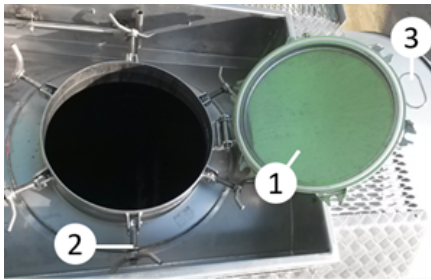

Manhole cover

 **In case tightening or loosening the clamps of manhole cover when the tank is under pressure, manhole cover may break off from tank body and may result in injuries even death. Never tighten or loosen the clamps of the manhole cover, when the tank is under pressure.**

 **If the threads of hatch clamps are damaged, manhole cover may break off from its body and may result in injuries even death.**

- Tank must not be under pressure even a single thread is damaged.
- Always tighten the levers manually.
- Replace immediately damaged threads.

 **Damaged thread of the hatch clamp cannot withstand inner pressure of tank and will be broken.**

### Consider the following subjects during opening or closing manhole cover:

- Check the contact surfaces of manhole cover are clean and non damaged before closing.
- After closing manhole covers, tighten hatch clamps crosswise and manually.
- Never tighten the hatch clamps with your foot, with a pipe, hammer or any other tool.
- Never retighten or loosen the hatch clamps of manhole cover when the tank is under pressure. Grease threads of hatch clamps regularly.

#### 4.1.5. Pressure Safety Valve

Pressure safety valve (1) is an important protective equipment. It prevents the explosion of the tank by keeping the pressure (operating pressure) in the tank constant at the set value during pressurized discharge. Pressure safety valve is located on the front part of the vehicle, on the side air line.

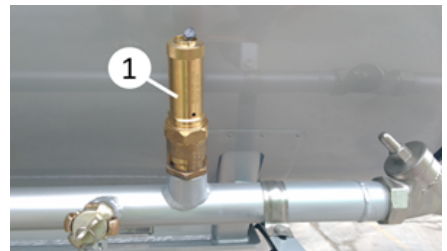

Pressure safety valve

#### 4.1.6. Ventilation Valves

These are the valves connected with one end to upper ventilation line and other end to open atmosphere. They balance the pressure inside the tank and provide ventilation of tank.

Valves in the pictures are;

When the left (1) side is **OPEN** and right (2) side is **CLOSED** air from the compressor enter to tank.

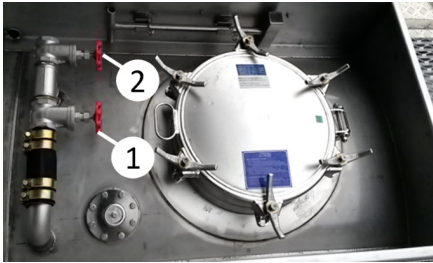

*Ventilation valves*

When the left (1) side is **CLOSED** and right (2) side is **OPEN** excess air is released to atmosphere.

#### 4.1.7. Vacuum Valve

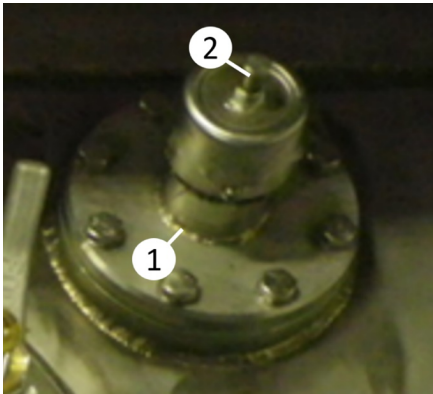

*Vacuum valve*

Vacuum valve (1) is an important protective equipment. Prevents negative pressure that may be generated by the variations on air pressure and temperature inside the tank. Protects against damage of tank due to pressure. As a standard, vacuum valve is located inside the spill box. Check the vacuum valve by means of the control lever (2) after each filling and discharging against the risk of sticking.

#### 4.1.8. Side Air Line

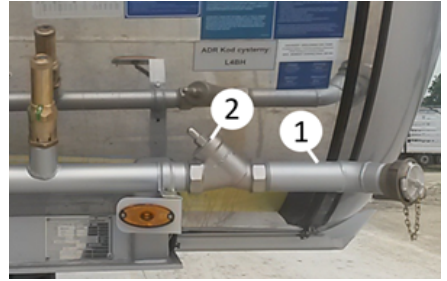

*Side air line*

It is the air line (1) that supplies air to the system by connecting to the compressor. On the side air line, a check valve (2) is installed to prevent return air to the compressor and prevent damages by this way.

#### 4.1.9. Jet Air Line

Jet air (1) helps to discharge material from discharge end. Material on discharge end is discharged quickly with the help of jet air. After discharge is completed, jet air free blowing mechanism in order to discharge the material remaining inside the bend is available in vehicle.

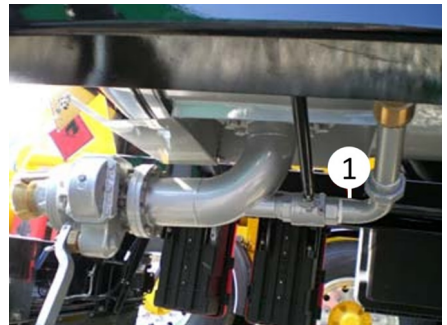

*Jet air line*

#### Opening jet air free blowing mechanism:

Pull the safety lock (2) towards yourself, open the mechanism (3) by turning counter clock wise.

#### Closing jet air free blowing mechanism:

After discharge of remaining material, close the mechanism (3) by turning clockwise and push the safety lock (2) forward.

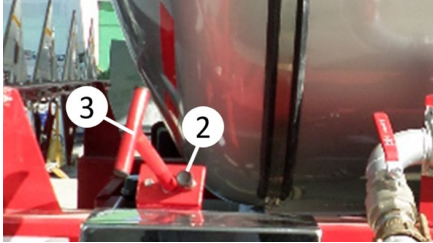

*Jet air free blowing mechanism*

 **If the remaining material in the discharge port is not discharged, it may solidify and block the discharge port.**

#### 4.1.10. Top Air Line

A top air line (1) exists above side air line, entering inside the tank just from front of hose carrier. Inlet location of air line may vary according to construction of vehicle. Air entering to tank by top air line keeps the inner part of tank under pressure and mixes inside of tank in order to easy and complete discharge of material. A manual valve (2) is located on the inlet of top air line, air entering to tank is controlled on this location.

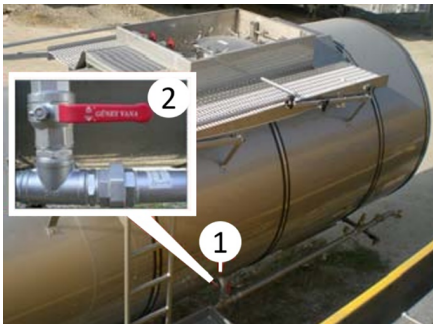

*Top air line*

#### 4.1.11. Bottom Valve

It is used for opening the bottom valve during discharge of vehicle. The bottom valve is controlled manually and pneumatically in 2 ways.

#### Handwheel bottom valve opening control

The bottom valve is opened and closed manually. The valve (1) is opened by turning the wheel counterclockwise, and closed by turning it clockwise. The open - closed status of the valve can be monitored with the open – closed status indicator (2).

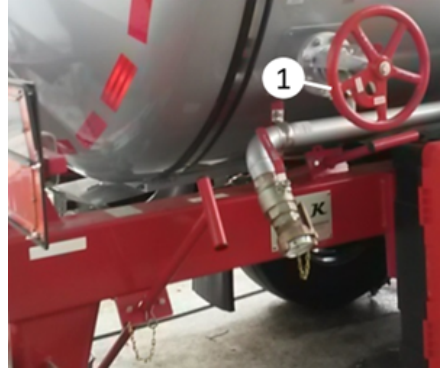

*Handwheel bottom valve opening control*

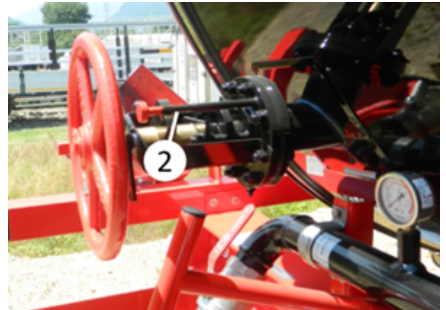

*Handwheel bottom valve opening control*

#### Pneumatic bottom valve opening control

The bottom valve is opened by pulling the pneumatic control button (3).

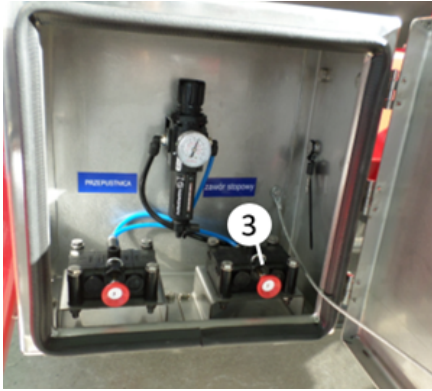

*Pneumatic bottom valve opening control*

The bottom valve is closed by pressing the pneumatic control button.



**The ability to control the pneumatic actuator with a remote control system can be added to the vehicle upon customer request.**

#### 4.1.12. Safety Valve

##### Gate Valve

The gate valve (1) is used to manually open and stop the flow.

##### Opening:

Remove the pin (2) on the valve extension lever, push the lever (3) forward to open the valve.

##### Closing:

Close the gate valve by pulling the lever towards you and fix it with the pin.

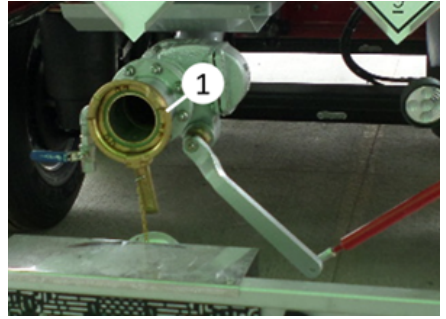

*Gate valve*



*Gate valve extension lever*

##### Pneumatic Butterfly Valve

The pneumatic butterfly valve (4) is used to open and stop the flow pneumatically.

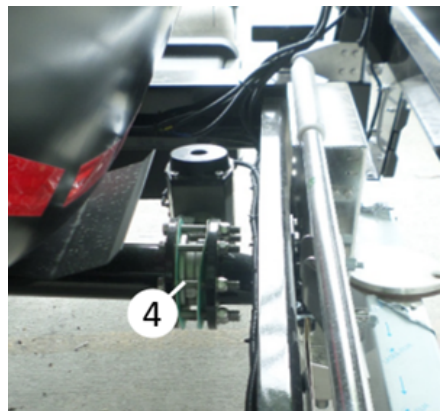

*Pneumatic butterfly valve*

Open the valve by pulling the pneumatic control button (5).

Close the valve by pressing the pneumatic control button.

In some cases, the butterfly valve that used as a safety valve may not be pneumatically controlled, but manually controlled.

 **The ability to control the pneumatic actuator with a remote control system can be added to the vehicle upon customer request.**

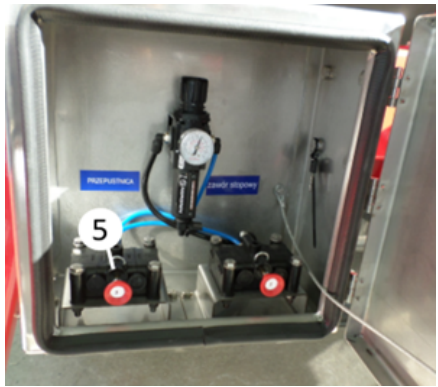

*Discharge pneumatic control box*

### 4.1.13. Remote Control System

It is the system that allows the control of the top air line, bottom valve and safety valve to be done with the remote control or the panel on the vehicle.

#### Remote control

##### Turning on the remote control:

- Rotate the emergency button (1) on the right side of the panel to open position.
- Rotate the power button (2) on the right side of the panel to open position.

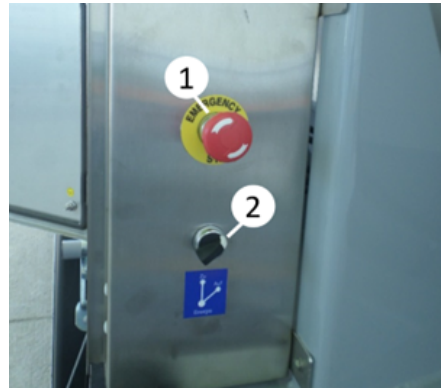

*Control panel*

- Rotate the button on the left end (3) of the panel to left to activate the control by remote.



*Control panel*

- Rotate the emergency button (4). Thus, the remote control switches from 'off' to 'on' and resumes standby status.
- LED light (5) on the upper centre on the control lights up continuously in green at standby.
- Two LED lights (6,7) on the bottom flashes in red.

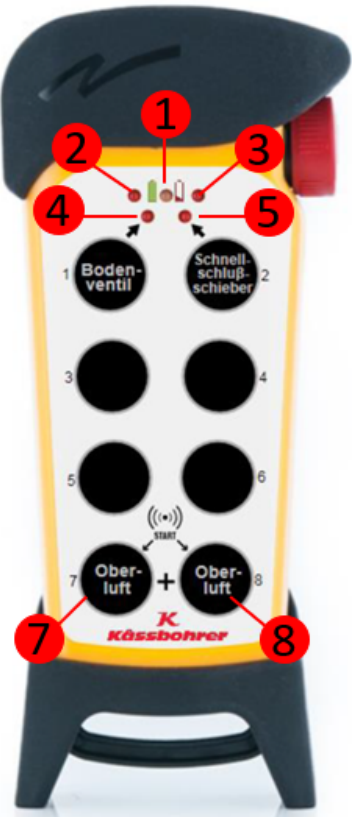
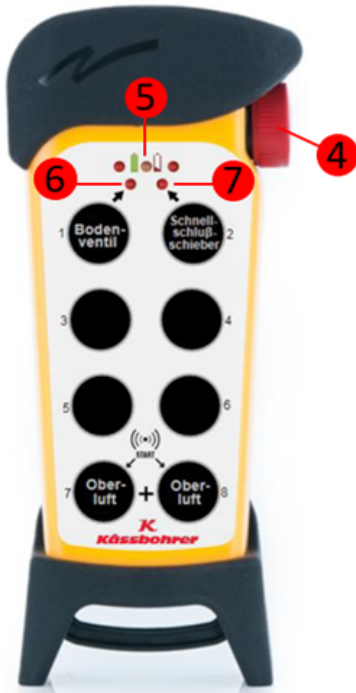

## Remote control

### Activation of the remote control:

- Press two buttons that says 'Ober-luft' (7,8) for minimum 2 seconds simultaneously.
- Thus, the remote control connects with the receiver inside the panel. No valve opens on the vehicle in this case.
- LED light (1) on the upper center flashes in green in the active condition.
- Other LED lights (2,3,4,5) lights up continuously in red.

### Opening and closing of the bottom valve:

When the button that says 'Boden-ventil' (1) is pressed, the pneumatic bottom valve, which is the first closing element of the discharge line on the rear side of tanker opens.

The relevant LED light (2) on the remote control illuminates.

In this case, the fluid inside the tanker moves inside the discharge line up to the safety valve, which is the next closing element.

When the button that says 'Boden-ventil' (1) is pressed again, the bottom valve is closed and the relevant LED light (2) turns off.

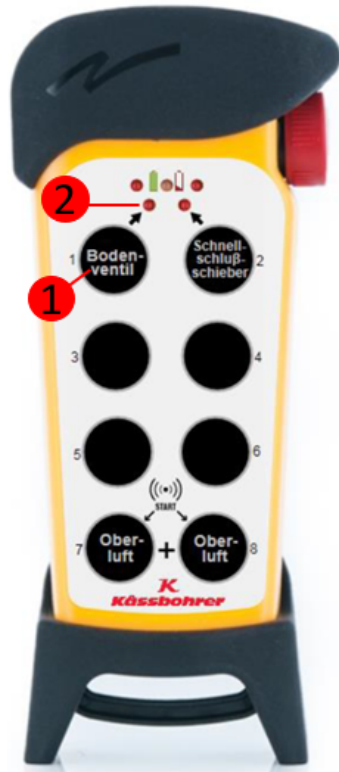
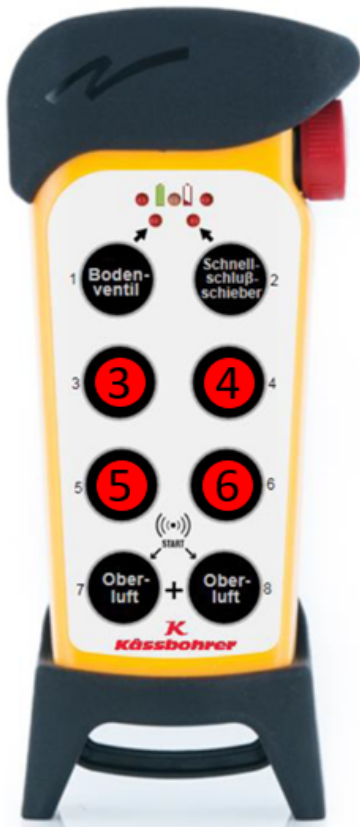

### Entering the PIN code to the remote control:

- Enter the PIN code specified (3-4-5-6) respectively using the buttons (3,4,5,6) on the remote control.
- A warning buzzer on the receiver inside the panel sounds for 3 seconds after entering the PIN code.
- Top air line valve opens automatically with this warning sound.

### Opening and closing the safety valve:

- When the button that says 'Schnellschlussschieber' (2) is pressed, the pneumatic safety valve, which is the second closing element of the discharge line on the rear side of tanker opens.
- The relevant light (3) on the remote control lights up.
- In this case, the fluid inside the tanker moves up to the hose coupling, which is the next closing element (if no hose is connected to the vehicle).
- If a discharge hose is connected to the vehicle before, the fluid inside the tanker starts to be discharged to

the tank on the other end of the fluid discharge hose.

- When the button that says 'Schnellschlussschieber' (2) is pressed again, the bottom valve closes and the relevant LED light (3) turns off.

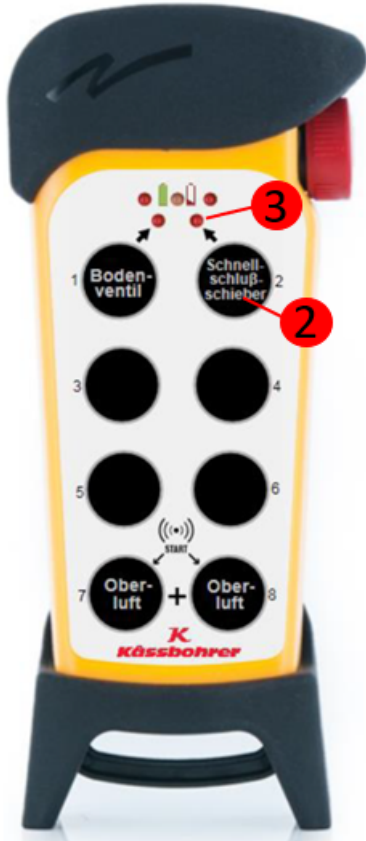

- Thus, all valves that has been opened earlier (top air line valve, pneumatic bottom valve, pneumatic safety valve) turn off automatically.

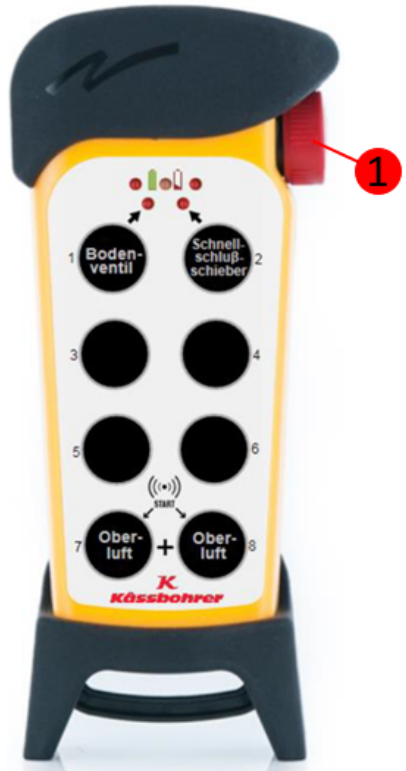

 The bottom valve and the safety valve can be opened at the same time or at different times.

#### Turning off the remote control:

- Press the emergency button (1) on the remote control to turn off the control.

#### Panel:

#### Turning on the control with the panel option;

- Rotate the emergency button (1) on the right side of the panel to open position.
- Rotate the power button (2) on the right side of the panel to open position.

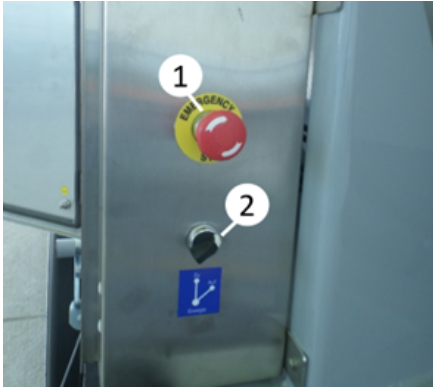

Control panel

- Rotate the button on the left end (3) of the panel to left to activate the control by panel.



Control panel

### Opening the top air line valve:

- Rotate the top air line valve button (4) on the panel to right to open the top air line valve.



Control panel

### Opening bottom valve;

- By turning the bottom valve button (5) on the panel to the right, the bottom valve is opened.

**i** The bottom valve will not open until the top air line valve is opened. (Even if the bottom valve button is turned on).



Control panel

### Opening safety valve;

- By turning the safety valve button (6) on the panel to the right, the safety valve is opened.



Control panel

 If the air pressure of the system is lower than 6.5 bar, the air tube of the trailer may be empty. Check the air tubes.

#### 4.1.14. Sampling Valve

It is used to take samples from the discharge outlet. Open by rotating the lever clockwise, close by turning it counter-clockwise.

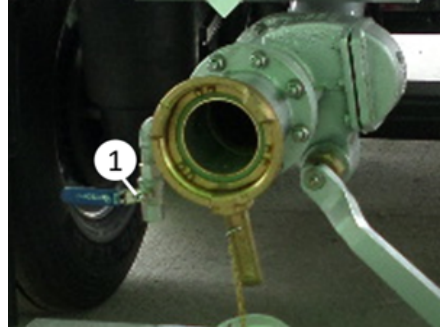

Sampling valve

 The safety valve can be opened independently of the top air line valve and the bottom valve.

#### Manometer;

- The manometer (7) on the panel displays the air pressure of the pneumatic system. The system operates at 6.5 bar optimally.



Control panel

#### 4.1.15. Thermometer

One thermometer (1) is located on the rear part of the tank, upper part of hand-wheel bottom valve control, in order to measure the temperature of the material inside the tank.

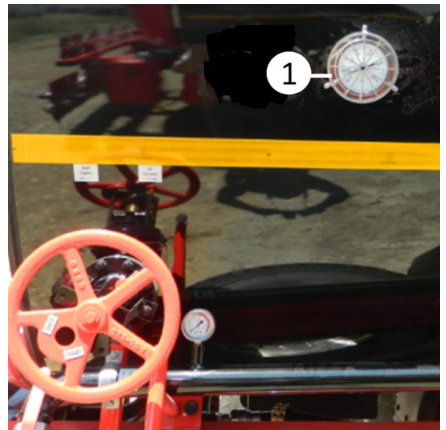

Thermometer

#### 4.1.16. Manometer

One thermometer (1) is located on the rear part of the tank, upper part of hand-wheel bottom valve control, in order to measure the temperature of the material inside the tank.

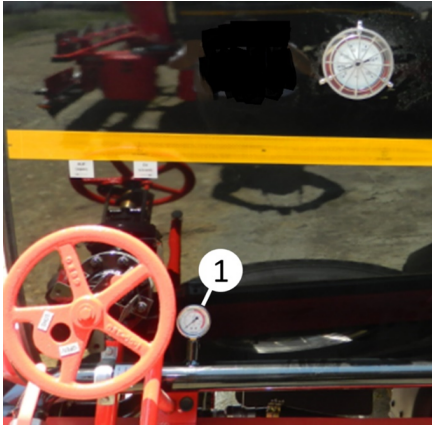

Manometer

Depending on the customer's request, another manometer (2) can be placed right after the pressure safety valve. The locations of the manometers vary according to the construction of the vehicle. When there is pressurized air in the system, it is important to monitor the pressure. Necessary measures should be taken immediately in case of pressure rise and fall.

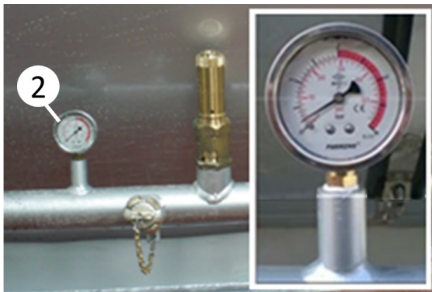

Manometer

#### 4.1.16.1. Drain Valves

Two discharge valves are located on spill box (1) around manhole cover and one on hose carrier (2). They are used for discharge of rain water, cleaning water

or any remaining material. Hose carrier discharge valve is located on back of the carrier, with opening of this valve collected water discharges directly to ground. Discharge openings on spill box are located just on the backside of ventilation valves, right and left hand sides; discharged water from there drains directly to ground from valves under the tank (3).

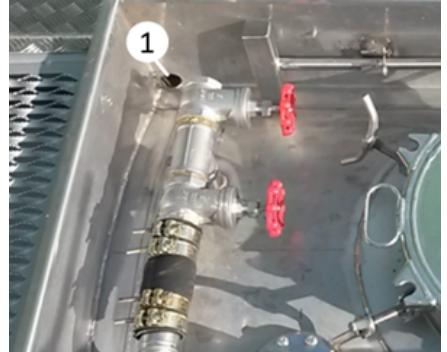

Drain hole



Drain valve



Bottom drain valve

### 4.1.17. Heating Line

STS tankers have a heating line to heat the transported material. Heating is being done in two different ways, with steam and liquid.

#### Heating with steam

- Connect the hose line that will supply the system with hot steam to the heating line inlet (1).
- Connect the hose line to be used to evacuate the steam in the system to the heating line outlet (2).
- Take the ball valve (3) to the closed position and perform the heating operation by giving hot steam to the system.
- The heating line is designed for a maximum pressure of 7 bar. The safety valve (4) on the line prevents the pressure in the system to exceed 7 bar.
- In addition, the pressure of the system can be observed with the manometer (5) on the heating line.

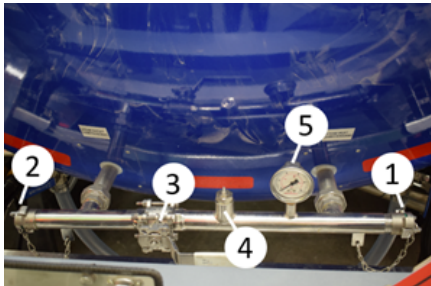

Heating line

#### Heating with liquid

Closed circuit heating system is used for heating with hot liquid.

The heater and the pump are usually placed inside the heater cabinet (6) on the left side of the tanker. The fuel tank (7), which provides the fuel requirement of the heater, is located over the cabinet.

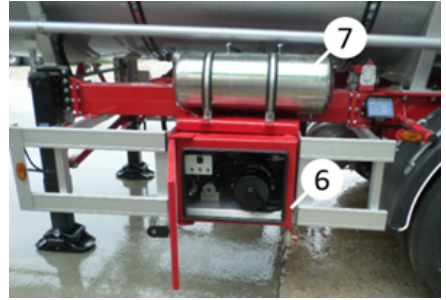

Heater cabinet and fuel tank

#### Operation of the liquid heating system:

- Liquid heating system works with 24 volt energy. It is energized by the socket (1) on the front of the tank.

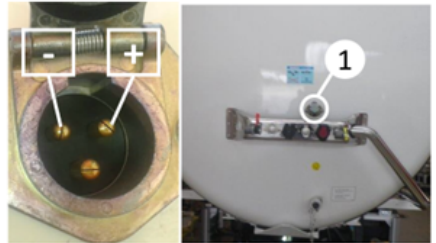

Electrical connection

**When making the electrical connection, the (+) pole and the (-) pole must not be confused.**

- Never confuse with (+) and (-) poles during the first connection to the tractor.
- The heater automatically stops at 78°C with the thermostat on it during operation, and restarts automatically at 72°C.
- Open the ball valve (2) at the inlet of the heating duct located at the back of the tank.

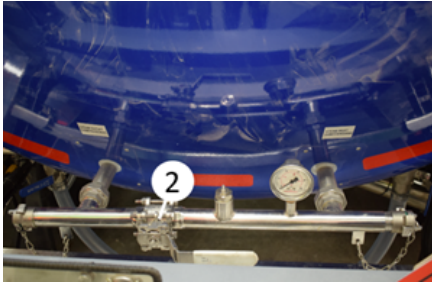

Ball valve

- The heater system has been tested in our factory and its liquid and anti-freeze have been completed. The air of the system is taken away.
- The system is operated by turning the switch (3) in the cabinet to the 'FLAME' position.



Switch in cabinet

- To turn off the system, set the switch to '0'.



**After the switch is turned to the '0' position, the heater continues to operate for a while. Do not disconnect the electrical connection of the vehicle during this period.**

#### 4.1.18. Warning Signs On the Tank

There are warning labels and plates (1) at various places on the tank, especially at the back of the tank. The purpose of these is to inform other drivers and people about the material in the tank and to remind people how to behave.

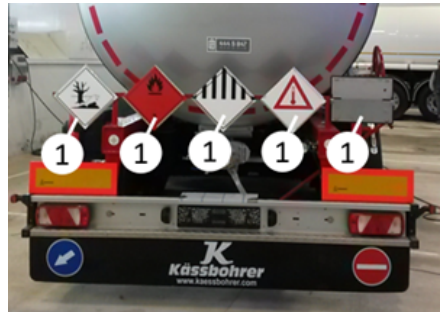

Warning signs



Warning signs

## 4.2. Chemical Tanker

### 4.2.1. Overview of Tank Components

Component	Function
Tank	It is the main body with cylindrical structure, manufactured from stainless steel.
Isolation coating	It prevents the transported material from freezing due to heat loss.
Manhole cover	It is used to fill from the top and enter the tank.

Pressure safety valve	It prevents the formation of pressure higher than the operating pressure in the tank.
Vacuum valve	It prevents negative pressure higher than the specified value that may occur in the tank.
Blast valve	In case the pressure in the tank exceeds 3.67 bar, it stabilizes the pressure and secures the tank.
Side air line	Delivers air taken from the compressor to the system.
Jet air line	It accelerates the discharge of the transported product by blowing it at the discharge outlet.
Top air line	It is the line that allows the air coming from the side air line to enter the tank.
Bottom valve	It is located at the bottom outlet of the tank and allows the transported product to be discharged from the tank.
Safety valve	It is the second valve between the bottom valve and the discharge outlet.
Sampling valve	It is used to take samples from the discharge outlet.
Thermometer	Measures temperature of material inside the tank.
Manometer	Measures pressure on the system.
Drain valves	They are used to drain rain water, cleaning water or any water accumulated in the manhole pool.
Heating line	It facilitates the discharge of the product inside the tank, which is welded from the outside to the bottom sheet of the tank, allowing steam or heating liquid to circulate inside, thus heating the product in the tank at the bottom.
Warning signs	It is used to inform other drivers and people about the material in the tank.
Ladder and handrail	It allows the operator to climb onto the vehicle and work safely.

#### 4.2.2. Tank

The tank of the chemical tanker vehicles is manufactured from stainless steel. Tank is coated by aluminium or stainless steel sheet after being insulated with glass wool. Tank is usually manufactured with single or triple compartments.

There are wave breakers inside the tank to prevent fluctuation of the material. These wave breakers prevent replacement of the product in case of abrupt breaking or take-offs, and thus prevent replacement of the centre of gravity of the vehicle to a certain extent. Change of the centre of gravity of the vehicle may affect the handling and control of the vehicle.

Be sure to walk on the walkway when you climb up the tank for filling the tank or for any other reason. Coated exterior surfaces may easily get damaged.



*Chemical tanker*

#### 4.2.3. Isolation Coating

Exterior of the tankers are insulated with glass wool and then coated with aluminium or stainless steel sheet to keep the material inside the tank at the required temperature. General purpose of the insulation is maintaining the temperature.



**Walk on the walkway when you climb up the tank. Do not step on the coating sheet to prevent damage to the coating sheet on the exterior surface of the tank.**

#### 4.2.4. Manhole Cover

Manhole is used for filling the tank from top. Vehicle can be filled from top by opening the upper cover, after the vehicle has approached to the station. Manhole cover is manufactured from stainless steel and is resistant to heat.

##### Opening the cover:

- There are hatch clamps (2) on the tank, loosen them by turning the levers.
- After loosening of all clamps, pull clamps backwards and lay on the tank.
- Hold the released cover by the handle (3) present on the cover and rest it on the edge of the spill box.



*Manhole cover*



**In case tightening or loosening the clamps of manhole cover when the tank is under pressure, manhole cover may break off from tank body and may result in injuries even death. Never tighten or loosen the clamps of the manhole cover, when the tank is under pressure.**



**If the threads of hatch clamps are damaged, manhole cover may break off from its body and may result in injuries even death.**

- Tank must not be under pressure even a single thread is damaged.
- Always tighten the levers manually.
- Replace immediately damaged threads.



**Damaged thread of the hatch clamp cannot withstand inner pressure of tank and will be broken.**

**Consider the following subjects during opening or closing manhole cover:**

- Check the contact surfaces of manhole cover are clean and non damaged before closing.
- After closing manhole covers, tighten hatch clamps crosswise and manually.
- Never tighten the hatch clamps with your foot, with a pipe, hammer or any other tool.
- Never retighten or loosen the hatch clamps of manhole cover when the tank is under pressure.
- Grease threads of hatch clamps regularly.

#### 4.2.5. Pressure Safety Valve

Pressure safety valve (1) is an important protective equipment. It prevents the explosion of the tank by keeping the pressure (operating pressure) in the tank constant at the set value during pressurized discharge. Pressure safety valve is located on the front part of the vehicle, on the side air line.

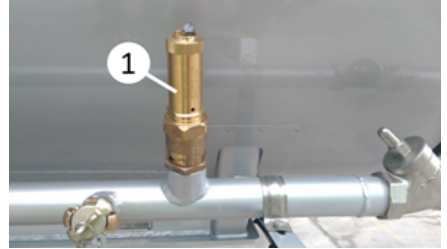

*Pressure safety valve*

#### 4.2.6. Vacuum Valve

Vacuum valve (1) is an important protective equipment. Prevents negative pressure that may be generated by the variations on air pressure and temperature inside the tank. Protects against damage of tank due to pressure. As a standard, vacuum valve is located inside the spill box.



*Vacuum valve*

#### 4.2.7. Blast Valve

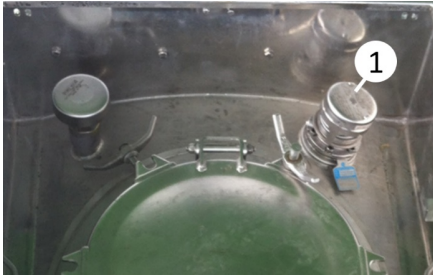

*Blast valve*

If the pressure of the blast valve (1) exceeds the set value for any reason, the pressure safety valve on it is activated and secures the tank.

#### 4.2.8. Jet Air Line

Jet air line supports discharging of the material from the discharge hole. The material that has reached the discharge hole discharges quickly by the help of the jet air. A jet air free blowing mechanism is available in the vehicle to discharge the material remaining in the elbow after the discharging operation is completed.

##### Opening jet air free blowing mechanism:

Remove the coupling at the end of the jet air line (1) and connect it to the compressor. Bring the lever (2) of the ball valve to open position.

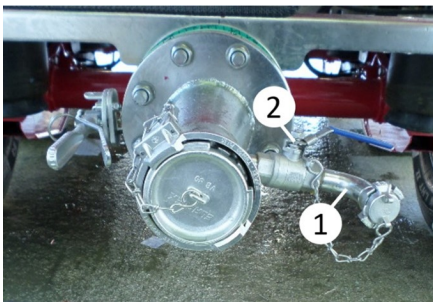

*Jet air free blowing mechanism*

##### Closing jet air free blowing mechanism:

After removing the remaining material, bring the lever (2) of the ball valve to closed position, remove the compressor connection and install the coupling to the end of the jet air line again.

As an option, pneumatic blowing mechanism is also provided.

##### Opening jet air pneumatic blowing mechanism:

Bring the lever (3) of the ball valve to open position.

##### Closing jet air pneumatic blowing mechanism:

After removing the remaining material, bring the lever (3) of the ball valve to closed position.

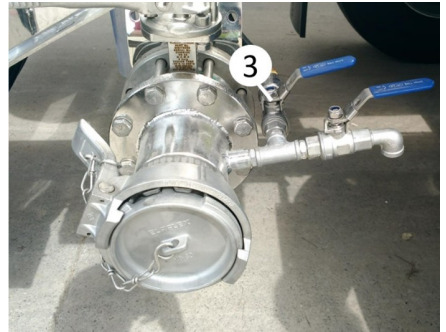

*Jet air pneumatic blowing mechanism*

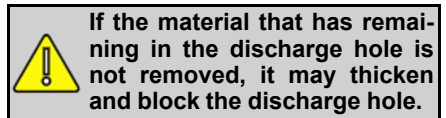

#### 4.2.9. Top Air Line

A top air line that enters the tank right before the hose carrier is available on the side air line. The entering point of the air line may vary according to the construction of the vehicle. The air entering into the tank via the top air line both keeps inside of the tank pressurized and mixes inside of the tank to ensure that the product is discharged completely and easily. The butterfly valve (2) on the top air line shall be opened and the ball valve (3) shall be brought to the closed

position to supply air to the inside of the tank. And both the butterfly valve (2) and the ball valve (3) shall be brought to the open position to discharge the air from the tank. Top air line may be equipped with a pneumatic actuator as per customer request. In such a case, open the valve of the top air line by pulling the control button (5) placed on the pneumatic control box of the pneumatic top air line valve (4).

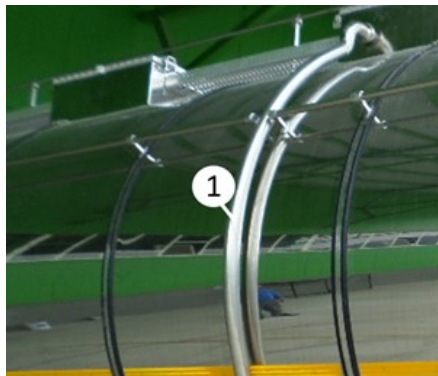

*Top air line*

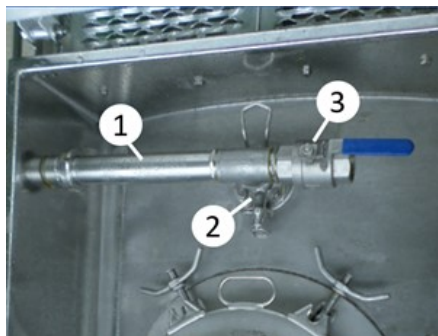

*Top air line*

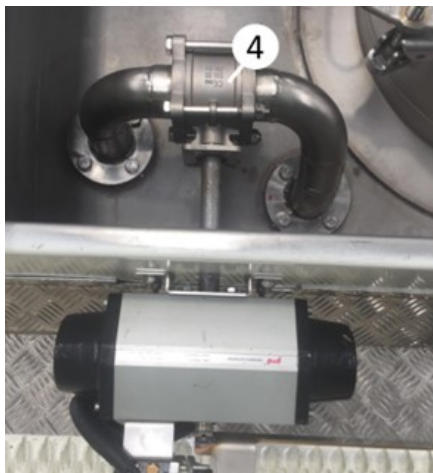

*Top air line valve*



*Pneumatic control box*

 **The feature for controlling the pneumatic actuator with a remote control system may be installed to the vehicle in case of customer request.**

#### **4.2.10. Bottom Valve**

Used for discharging the product available in the vehicle. Bottom valve is controlled pneumatically.

#### **Pneumatic bottom valve opening control**

Bottom valve is opened and closed by controlling the pneumatic actuator (1)

with the pneumatic bottom valve button (2) inside the control cabinet.

Bottom valve is opened by pulling the pneumatic control button (2).

Bottom valve is closed by pressing the pneumatic control button (2).

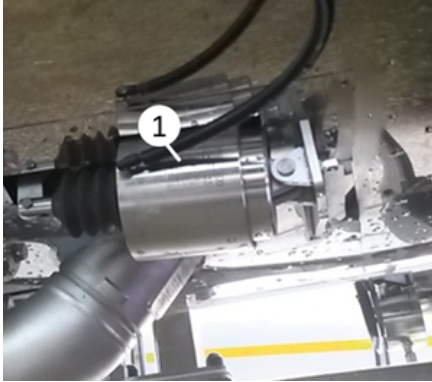

*Pneumatic actuator*

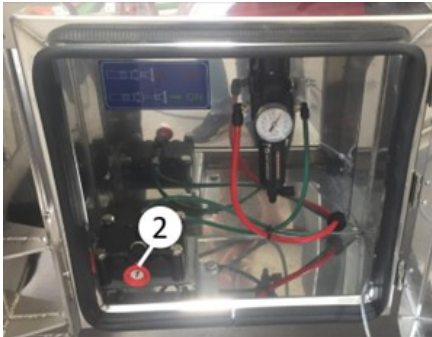

*Pneumatic control button*

#### 4.2.11. Safety Valve

##### Manually Controlled Butterfly Valve

Manually controlled butterfly valve (1) is used for turning on or off flow manually.

##### Opening:

Bring the lever of the valve (2) to 'OPEN' position in order to turn on the flow.

##### Closing:

Bring the lever of the valve (2) to 'CLOSED' position in order to turn off the flow.

##### Pneumatically Controlled Butterfly Valve

Pneumatically controlled butterfly valve (3) is used for turning the flow on or of pneumatically.

Open the valve by pulling the pneumatic control button (4).

Close the valve by pressing the pneumatic control button (4).

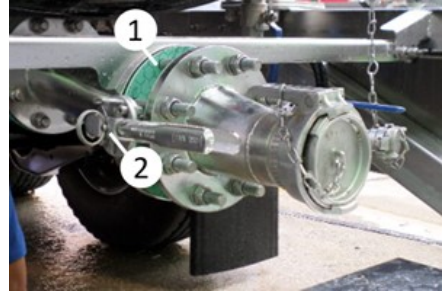

*Butterfly valve*

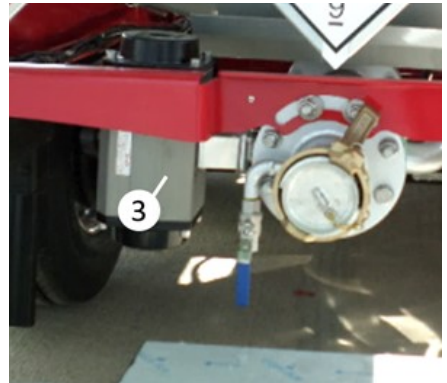

*Pneumatically controlled butterfly valve*

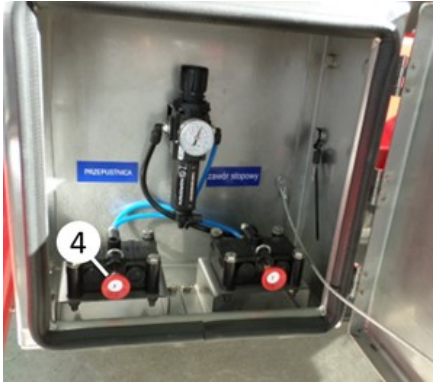

*Pneumatic control button*

#### 4.2.12. Sampling Valve

It is used to take samples from the discharge outlet. Open by rotating the lever clockwise, close by turning it counter-clockwise.

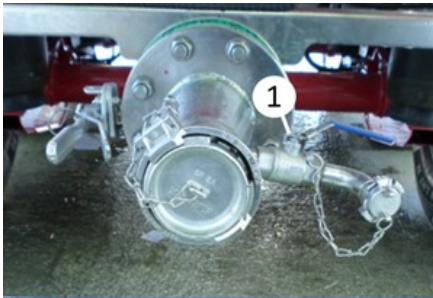

*Sampling valve*

#### 4.2.13. Thermometer

One thermometer (1) is located on the rear part of the tank, upper part of hand-wheel bottom valve control, in order to measure the temperature of the material inside the tank.

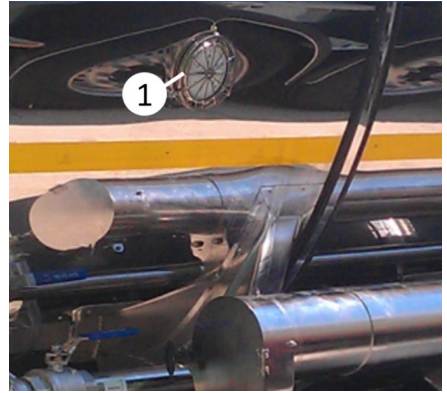

*Thermometer*

#### 4.2.14. Manometer

There is a manometer (1) right after the pressure safety valve on the side air line to measure the pressure in the system. Monitoring of the pressure is important when there is pressurized air inside the system. The required countermeasures must be taken immediately when the pressure is raised or lowered.

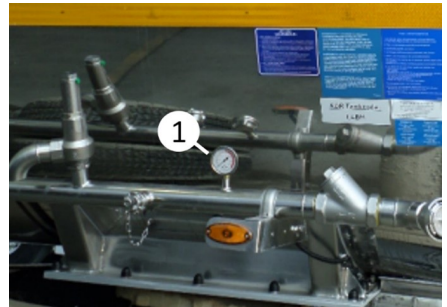

*Manometer*

#### 4.2.15. Drain Valves

There are two discharge valves on the spill box (1) around the manhole cover, and there is one discharge valve on the hose carrier (2). These are used for discharging rain water, cleaning water and water collected here in any way. Hose carrier is located behind the discharge valve carrier, the water collected is discharged directly to ground when this valve is opened. Discharge holes are located on the left and right behind the spill

box pool. Water discharged from here is discharged to the ground from the valve (3) under the tank.

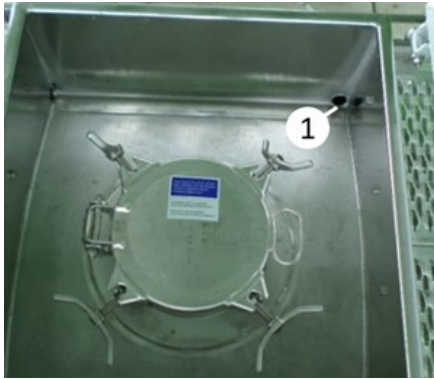

Drain hole



Drain valve

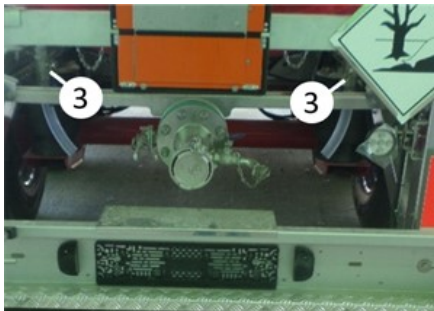

Drain valve

#### 4.2.16. Heating Line

There is heating line for heating the material carried in STC tankers. Heating operation is performed by 2 different methods, namely by steam and liquid.

#### Heating by Steam

- Hose line that shall provide the hot steam to the system shall be connected to the heating line inlet line (1).
- Hose line that shall be used for discharging the steam in the system shall be connected to the heating line outlet (2).
- Bring the ball valve (3) to closed position and perform the heating operation by supplying hot steam to the system.
- Heating line is designed for a pressure of 7 bars maximum. Safety valve on the line (4) prevents the pressure on the system from exceeding 7 bars.
- Also, system pressure may be observed with the pressure gauge (5) on the heating line.

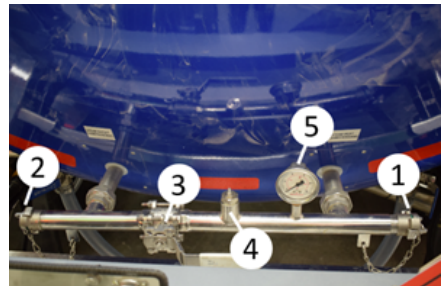

Heating line

#### Heating by liquid

Closed circuit heating system is used for heating with hot water.

Heater and the pump are usually placed inside the heater cabinet (6) on the left side of the tanker. The fuel tank (7) that provides the fuel requirement of the heater is located on the cabinet.

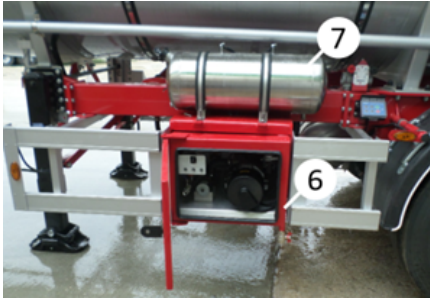

Heater cabinet and fuel tank



**After the switch is turned to the '0' position, the heater continues to operate for a while. Do not disconnect the electrical connection of the vehicle during this period.**

### Operation of the liquid heating system:

- Liquid heating system works with 24 volt energy. It is energized by the socket (1) on the front of the tank.

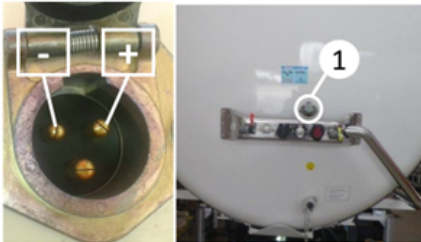

Electrical connection



**When making the electrical connection, the (+) pole and the (-) pole must not be confused.**

- Never confuse with (+) and (-) poles during the first connection to the tractor.
- The heater automatically stops at 78°C with the thermostat on it during operation, and restarts automatically at 72°C.

- Open the ball valve (2) at the inlet of the heating duct located at the back of the tank.

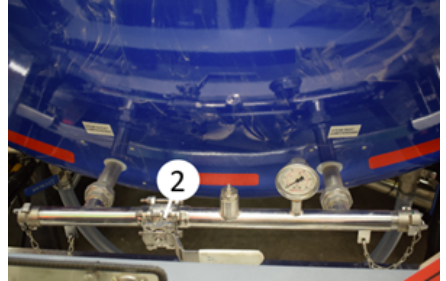

Ball valve

- The heater system has been tested in our factory and its liquid and anti-freeze have been completed. The air of the system is taken away.
- The system is operated by turning the switch (3) in the cabinet to the 'FLAME' position.

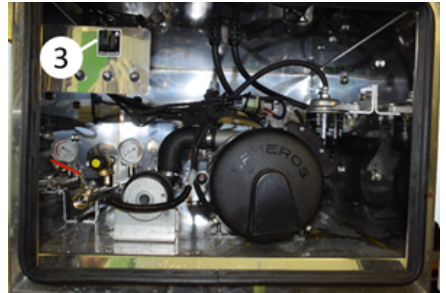

Switch in cabinet

- To turn off the system, set the switch to '0'.



**After the switch is turned to the '0' position, the heater continues to operate for a while. Do not disconnect the electrical connection of the vehicle during this period.**

### 4.2.17. Warning Signs On the Tank

There are warning labels and plates (1) at various places on the tank, especially at the back of the tank. The purpose of these is to inform other drivers and

people about the material in the tank and to remind people how to behave.

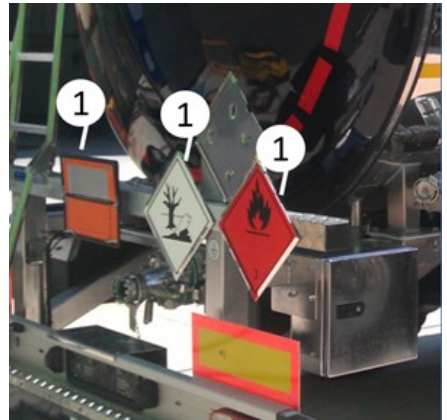

*Warning signs*

### 4.3. Food Tanker

#### 4.3.1. Overview of Tank Components

Component	Function
Tank	It is the main body with cylindrical structure, manufactured from stainless steel.
Isolation coating	It prevents the transported material from freezing due to heat loss.
Manhole cover	It is used to fill from the top and enter the tank.
Breather valve	It allows the tank to breathe.
Cleaning line	It is the line that allows the inside of the tank to be cleaned by means of cleaning balls.
Bottom valve	It is located at the bottom outlet of the tank and allows the transported product to be discharged from the tank.
Discharge valves	It provides the flow of the product discharged through the bottom valve to the discharge hose.
Thermometer	Measures temperature of material inside the tank.
Drain valves	They are used to drain rain water, cleaning water or any water accumulated in the manhole pool.

Ladder and handrail	It allows the operator to climb onto the vehicle and work safely.
Portable stepladder	It is used to enter the tank.

#### 4.3.2. Tank



Food tanker

The tank of the food tanker vehicles is manufactured from stainless steel. The body area of the tank is covered with polyurethane, and the domes are insulated with glass wool and then covered with stainless steel sheet. Tank is usually manufactured with triple compartments.

#### 4.3.3. Isolation Coating

Since food tankers generally carry perishable food, the outside of the tankers is insulated with polyurethane and glass wool and covered with stainless steel sheet in order to keep the material in the tank at the required temperature. The general purpose of insulation is to preserve heat.



**Walk on the walkway when you climb up the tank. Do not step on the coating sheet to prevent damage to the coating sheet on the exterior surface of the tank.**

#### 4.3.4. Manhole Cover

Manhole is used for filling the tank from top. Vehicle can be filled from top by opening the upper cover, after the

vehicle has approached to the station. Manhole cover is manufactured from stainless steel and is resistant to heat.

#### Opening the cover:

- There is a screwed wing nut (2) on the cover, loosen the nut by turning it.
- After loosening the wing nut, lean the nut back onto the spill box.
- Hold the handle (3) on the released cover and lean it against the edge of the spill box.

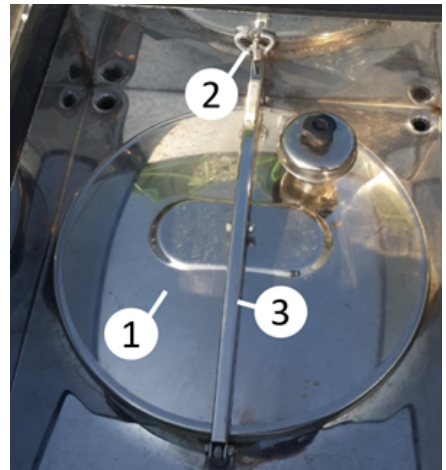

Manhole cover



**If the threads of the wing nut are damaged, the manhole cover cannot be fully fit on the seal and loss of material may occur from the manhole during transportation.**

**Consider the following points when opening and closing the manhole cover:**

- Before closing, check whether the contact surfaces of the manhole and the manhole cover are clean and undamaged.
- After closing the manhole cover, tighten the wing nut only by hand.
- Never tighten the wing nut with your foot, pipe, hammer or any other tool.

#### 4.3.5. Breather Valve

It is the equipment (1) located on the manhole cover that allows the tank to breathe and thus eliminates the risk of vacuum during discharge. The plastic nut (2) on the breather cover should be removed and the top cover should be removed and the inside of the breather should be cleaned regularly.

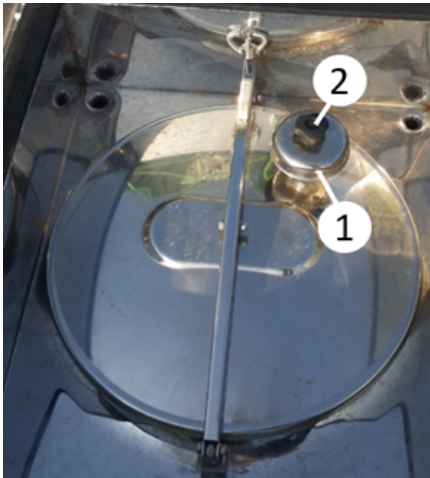

*Breather valve*

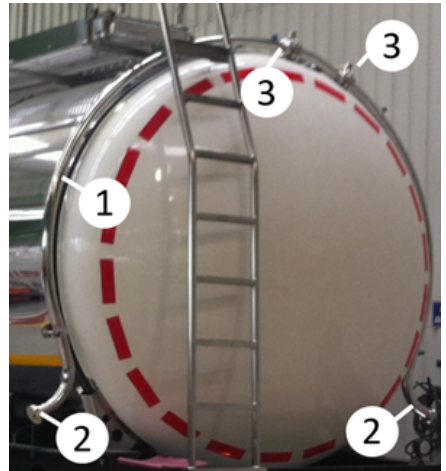

*Cleaning line*



*Blind cover*

#### 4.3.6. Cleaning Line

It is the line (1) that allows cleaning the inside of the tank. Remove the blind cap (2) at the cleaning line inlets on the right and/or left of the tank and connect it to the hot steam or water line. Open the DN50 butterfly valve (3) on the connecting side and the DN25 butterfly valves (4) that control the line entering the tank, and spray the cleaning agent into the tank through the cleaning balls (5) and the cleaning process is performed.

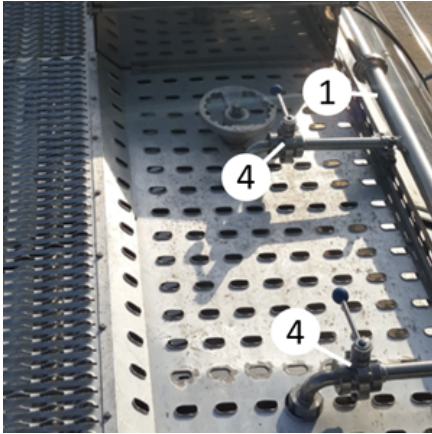

*Cleaning line and butterfly valves*



*Butterfly valves*

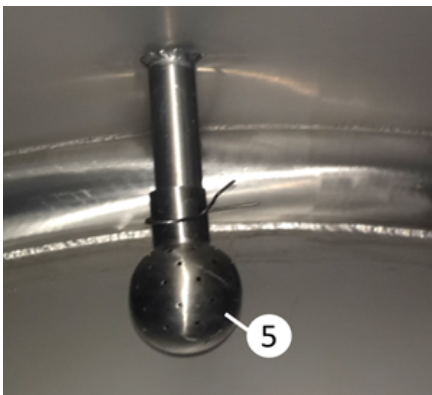

*Cleaning lines*

#### **4.3.7. Bottom Valve**

It is used to discharge the product in the tank. The bottom valve (1) is controlled manually.

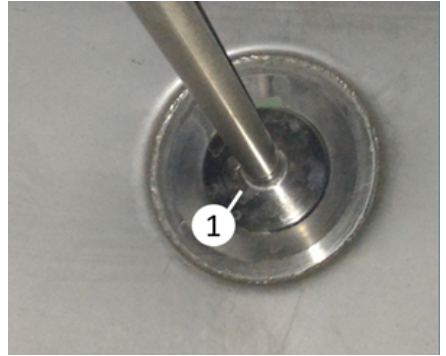

*Bottom valve*

#### **Handwheel bottom valve opening control:**

The handwheel bottom valve opening control (2) is used to open and close the bottom valve. The valve is opened by turning the handwheel counterclockwise and closed by turning it clockwise.

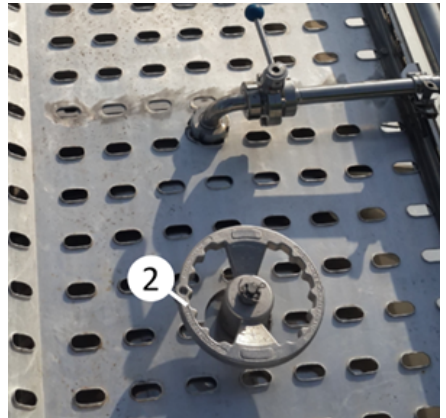

*Handwheel bottom valve opening control*

#### **4.3.8. Discharge Valves**

At the end of the discharge line, the discharge valves (1) are provided as standard on the right and rear of the vehicle, optionally on the left. It is used to open and cut the flow manually. The rear drain valve is located inside the armature box.

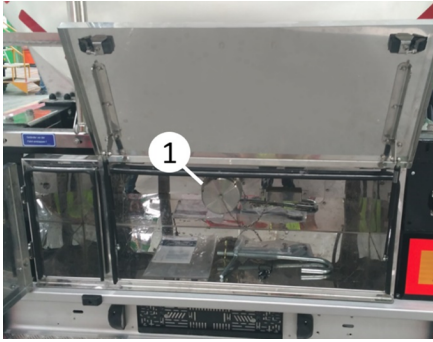

Rear discharge valve



Side discharge valves

#### 4.3.9. Thermometer

In order to measure the temperature of the material in the tank, there are a total of three thermometers (1), one in each compartment of the tank.

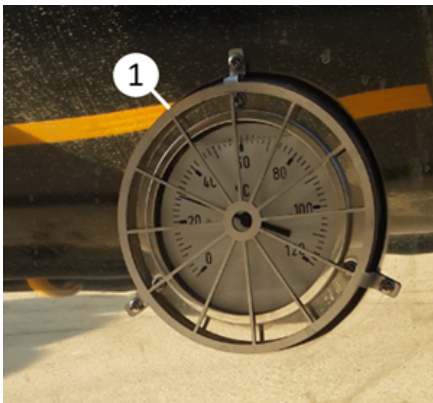

Thermometer

#### 4.3.10. Drain Valves

Two discharge valves are located on spill box (1) around manhole cover. They are used for discharge of rain water, cleaning water or any remaining material. Drain holes are located behind the spill box on the right and left, and the water drained from here is discharged to the ground through the valves (2) at the bottom of the tank.

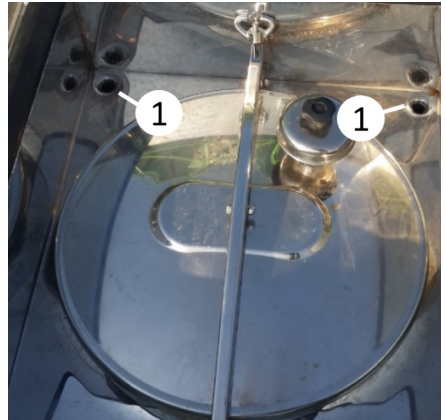

Drain holes



Bottom drain valve

## 4.4. Waste Tanker

### 4.4.1. Overview of Tank Components

Component	Function
Tank	It is the main structure made of stainless steel and carrying liquid waste products.
Filling manhole	It is used to fill from the top and enter the tank.
6" Pneumatic control gate valve for ventilation	It is the valve used for tank ventilation.
Safety valve	It is the valve used to balance the pressure.
Vacuum valve	It prevents negative pressure higher than the specified value that may occur in the tank.
Tank ventilation line	It is the line used for tank ventilation.
Pneumatic overfill protection for stop the pump	Indicates the filling level, pneumatically controlled.
Filling funnel	It is used to fill the tank.
Filling funnel 8" pneumatic control gate valve	It is a pneumatically controlled valve for filling.
Tank level indicator	It visually shows the filling level.
6" manual control gate valve	It is used to control the discharge line.
Perrot coupling	It is the valve that provides connection for discharge.
Turning joint	It serves to turn the discharge pipe for right and left discharge.
Pump	It is the component that provides discharging by sucking the material from the tank during discharge.
3 Way ball valve	It is the component that allows the material to be bypassed into the pump line or into the tank.

Discharge pump outlet line	It is the pipeline that provides the discharge
Tank mixing, pump inlet line	It is the pipeline that provides the pump inlet for the tank mixture.
Discharge pump inlet line	It is the pipeline that provides the pump inlet.
Tank mixing, pump outlet line	It is the pipeline that provides the pump outlet for the tank mixture.
Sampling valve	It is the valve used to take samples from the product
Perrot coupling cover	It is the cover used for closing the port after filling and discharging.
Hydraulic control lever	It is the component used for the commissioning of the hydraulic installation.
Hydraulic pressure gauge	It is the indicator showing the pressure in the hydraulic line.
Pneumatic valve	It is the valve that operates the product pump for 10 seconds.
Filling funnel valve	Filling funnel valve on-off pneumatic valve
Pneumatic manometer	It is the indicator showing the pressure in the pneumatic line.
Pneumatic valve for tank ventilation	It is a tank ventilation on-off pneumatic valve.
Central lubrication system	It is the component used for the automatic lubrication of the system.
Central lubrication electronic counter system	This system ensures that the central lubrication works for 45 seconds when the brake is pressed 100 times.
Central lubrication on/off button	It is the button for central lubrication on/off operation.
Hydraulic quick coupling	It provides the hydraulic connection between the tractor and the trailer.

#### 4.4.2. Tank

Tank (1) is the main structure made of stainless steel and carrying liquid waste products.

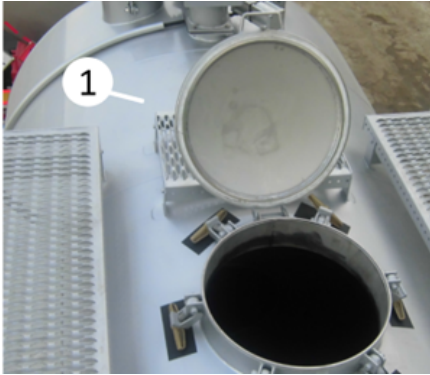

Tank

#### 4.4.3. Filling Manhole

Filling manhole (2) is used to fill from the top and enter the tank.

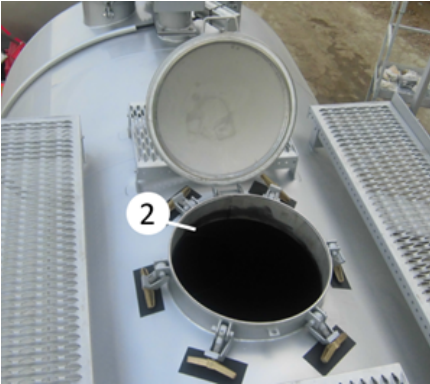

Filling manhole

#### 4.4.4. 6" Pneumatic Control Gate Valve For Ventilation

It is the valve (3) used for tank ventilation.



Pneumatically controlled ventilation valve

#### 4.4.5. Safety Valve

It is the valve (4) used to balance the pressure.

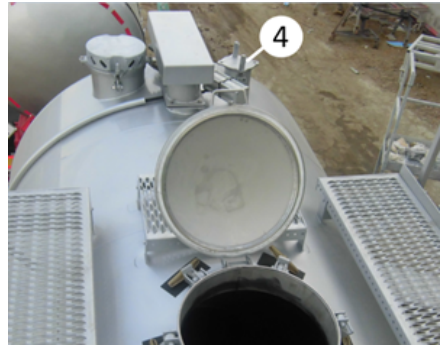

Safety valve

#### 4.4.6. Vacuum Valve

Vacuum valve (5) prevents negative pressure higher than the specified value that may occur in the tank.



Vacuum valve

#### 4.4.7. Pneumatic Valve for Tank Ventilation

It is a tank ventilation on-off pneumatic valve (27).

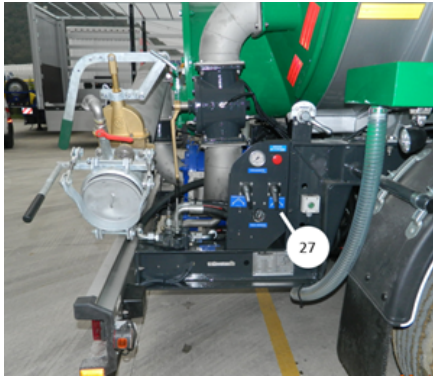

*Tank ventilation valve*

#### 4.4.8. Pneumatic Overfill Protection For Stop The Pump

Float (7) indicates the filling level, pneumatically controlled.



*Float*

#### 4.4.9. Filling Funnel

Filling funnel (8) is used to fill the tank.

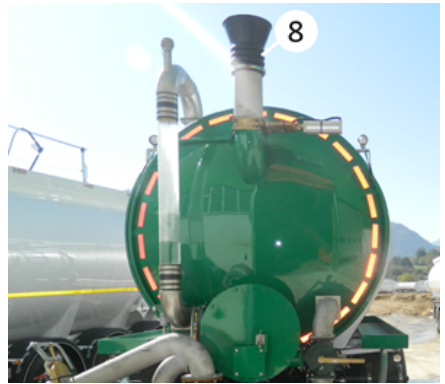

*Filling funnel*

#### 4.4.10. Filling Funnel 8" Pneumatic Control Gate Valve

It is a pneumatically controlled valve (9) for filling.

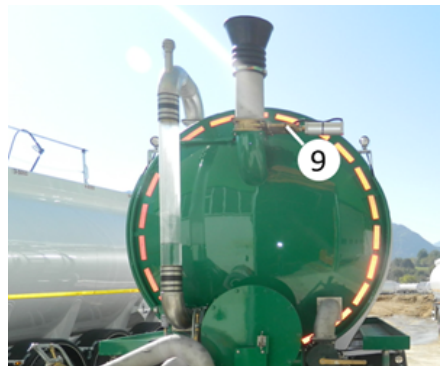

*Pneumatic control valve*

#### 4.4.11. Tank Level Indicator

Tank level indicator (10) visually shows the filling level.



Tank level indicator

#### 4.4.12. 6" Manual Control Gate Valve

Manuel control gate valve (11) is used to control the discharge line.

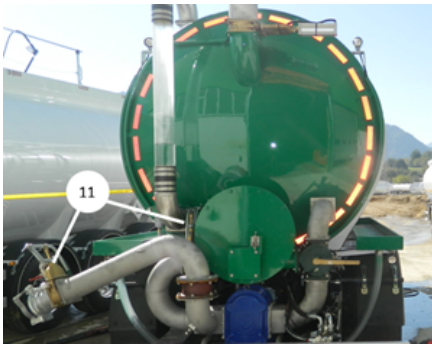

Manual control gate valve

#### 4.4.13. Perrot Coupling

It is the valve (12) that provides connection for discharge.



Perrot coupling

#### 4.4.14. Turning Joint

Turning joint (13) serves to turn the discharging pipe for right and left discharge.



Turning joint

#### 4.4.15. Pump

It is the component (14) that provides discharging by sucking the material from the tank during discharge.



Pump

#### 4.4.16. 3 Way Ball Valve

It is the component (15) that allows the material to be bypassed into the pump line or into the tank.



*Ball valve*

#### 4.4.17. Discharge Pump Outlet Line

It is the pipeline (16) that provides the discharge.



*Discharge pump outlet line*

#### 4.4.18. Tank Mixing Pump Inlet Line

It is the pipeline (17) that provides the pump inlet for the tank mixture.



*Tank mixing pump inlet line*

#### 4.4.19. Discharge Pump Inlet Line

It is the pipeline (18) that provides the pump inlet.



*Discharge pump inlet line*

#### 4.4.20. Tank Mixing Pump Outlet Line

It is the pipeline (19) that provides the pump outlet for the tank mixture.



*Tank mixing pump outlet line*

#### 4.4.21. Sampling Valve

It is the valve (20) used to take samples from the product.

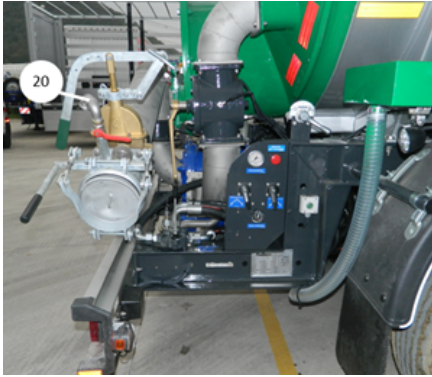

*Sampling valve*

#### **4.4.22. Perrot Coupling Cover**

It is the cover used for closing the port after filling and discharging (21).

Perrot coupling cover

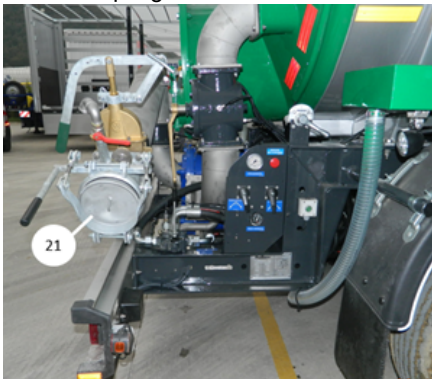

#### **4.4.23. Hydraulic Control Lever**

It is the component (22) used for the commissioning of the hydraulic installation.



*Hydraulic control lever*

#### **4.4.24. Hydraulic Pressure Gauge**

It is the indicator (23) showing the pressure in the hydraulic line.



*Hydraulic pressure gauge*

#### **4.4.25. Pneumatic Valve**

It is the valve (24) that operates the product pump for 10 seconds.



*Pneumatic valve*

#### **4.4.26. Filling Funnel Valve**

It is the filling funnel valve on-off pneumatic valve (25).



*Filling funnel valve*

#### **4.4.27. Pneumatic Manometer**

It is the indicator (26) showing the pressure in the pneumatic line.



*Pneumatic manometer*

#### **4.4.28. Pneumatic Valve for Tank Ventilation**

It is a tank ventilation on-off pneumatic valve (27).



*Tank ventilation valve*

#### **4.4.29. Central Lubrication System**

It is the component (28) used for the automatic lubrication of the system.

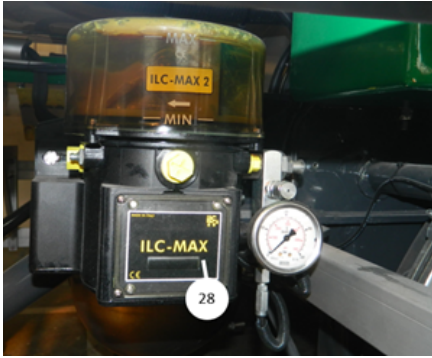

*Central lubrication system*

#### **4.4.30. Central Lubrication Electronic Counter System**

This system (29) ensures that the central lubrication works for 45 seconds when the brake is pressed 100 times.



*Central lubrication electronic counter system*

#### **4.4.31. Central Lubrication On / Off Button**

It is the button (30) for central lubrication on/off operation.



*Central lubrication on – off button*

#### **4.4.32. Hydraulic Quick Coupling**

Hydraulic quick coupling (31) provides the hydraulic connection between the tractor and the trailer.



*Hydraulic quick coupling*

## 5. TRANSPORTATION PROCESS

### 5.1. Pre-Driving Checks

- Make sure that all necessary documentation is available at the vehicle,
- Make sure all necessary adjustments and loading condition are properly made,
- The vehicle is coupled and secured with the tractor properly and safely,
- Make sure that all pneumatic and electrical connections between the tractor and the vehicle are properly made and that the EBS system is operational,
- All structural hardware (wheel chocks, side underrun guards, ladder and etc.) are in their place and locked or secured properly,
- The load is distributed evenly to prevent any displacement during driving,
- The weight of the load is within the permissible limits,
- Comply with the regulations of the country you are in,
- Make sure that the lighting and signal system is fully operational,
- The tire air pressures are at the required level,
- The parking brake of the semi-trailer is released,
- All valves and manhole covers are closed and secured,
- The material hoses are safely removed.

### 5.2. Semi-Trailer and Tractor Coupling

Apply the following steps to couple the semi-trailer with the tractor:

- Check that kingpin and its couplings are normal. Make sure that there is an adequate amount of grease oil on the fifth wheel, top-connection plate and kingpin that will prevent damage when coupling and that it does not contain any dust and contaminant.
- Lower the height of the rear suspension airbags of the tractor until it can be inserted in the king pin section of the semi-trailer.
- Set the 5th wheel locking system on the tractor to the "On" position.
- Adjust the height of the semi-trailer to insert it into the tractor. The height of the semi-trailer can be adjusted with the mechanical landing gear. Prevent the movement of the semi-trailer by using the parking brake. Put wheel chock at the rear of the wheels for safety.
- Move the tractor, fifth wheel until it touches the top-connection plate of the semi-trailer and moves backwards slowly on the same level. The fifth wheel will slide smoothly under the top-connection plate and enter the kingpin's shoes and lock automatically with the intensity of impact.
- Raise the landing legs of the semi-trailer and insert the landing legs arm to its place.
- Connect the air, electrical and EBS cables and hoses to their places on the tractor. Be sure that all the functions are working properly.
- If the vehicle has a parking brake, release the parking brake.



If your vehicle is driven at the wrong 5th wheel height, malfunctions may occur in the vehicle. You may have height problems.. The vehicle must be driven at the correct fifth wheel height.

Apply the following steps to uncouple the semi-trailer with the tractor:

- If the vehicle is equipped with service type brake chambers, apply the parking brake after checking the brake drum. Never apply the parking brake when the brake drums are very hot. (The drum may crack.)
- If the vehicle has a hand-brake type brake, put a wheel chock in front of the vehicle. Apply the handbrake.
- Disconnect the brake air lines, the brake will be applied automatically. Disconnect the semi-trailer electrical connections.
- Lower the mechanical landing gear of semi-trailer (use high speed). When the mechanical landing gear feet or wheels touch the ground, switch the mechanical landing gear crank handle to low-speed position to raise the semi-trailer.
- Unlock the fifth wheel lock. Separate the tractor from the semi-trailer about 500 mm by slowly moving the tractor forward. Lower the level of the rear suspension airbags of the tractor and leave the semi-trailer's bottom.



To ensure that that the king pin is locked properly, engage the first gear of the tractor, and press the gas pedal, when you are slowly releasing the clutch, you will feel that the tractor strives to move the semi-trailer, this indicates that the connection is made properly. During the travel, this connection must be checked carefully to prevent separation of the semi-trailer from the tractor accidentally.

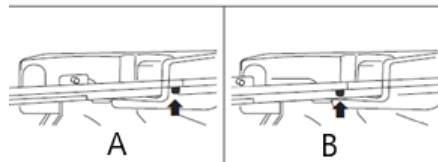
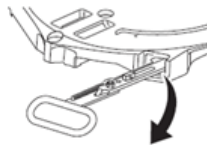

*Fifth wheel locking system*

A- Locked

B- Unlocked

### 5.3. Cautions During the Parking and Stopping

- Involuntary trailer movements, unstable posture and insufficient safety at night may occur serious accidents and injuries.
- Use the parking brake and wheel chocks while stopping.
- If you are going to park the vehicle in a public traffic area, you must use the necessary marking plate in accordance with legal regulations.

### 5.4. Reversing Camera

Your vehicle may optionally have a covered camera system connected to the reversing signal. In the covered system, the reverse signal triggers a solenoid valve and the cover opens and closes.

The camera is active after reversing. It provides extra protection against rain and theft. The monitor is not included in the system.

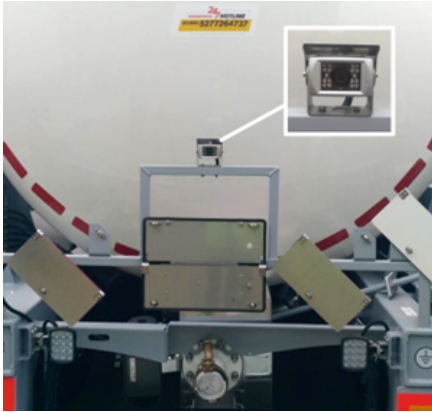

*Reversing camera*

## **5.5. Important Technical Considerations**

### **5.5.1. Fire Extinguisher**

Have fire extinguishers checked periodically every year and if necessary, fill them up. In case you use the fire extinguisher, fill it immediately.

#### **Precautions in case of fire:**

Some sealing materials let out gas when burned; these gases may become abrasive acid in contact with water, thus, never touch the fire extinguisher liquid accumulations, without wearing protective gloves.



*Fire Extinguisher Box*

### **5.5.2. Wheel Chocks**

Keep the wheel chocks in their place and place them under the wheels during parking. Do not forget to remove the wheel chocks before setting off.

### **5.5.3. Modifications on the Trailer**

Repairing and modification operations must be made by only authorized services. Otherwise, your vehicle may be out of warranty.

### **5.5.4. Air Leakage**

In case the air pressure in the air tubes drops instantly with the engine stop, this means that there is a leakage in the pneumatic system. Contact the nearest authorized service in such a case. The air leakage not only affects the safety of the braking system but also negatively affects the load lifting capacity of air-bags.

### **5.5.5. Oils**

Avoid contact with vehicle oils.

This can be dangerous to your health.

### 5.5.6. Welding

Never do any welding work on the vehicle body and chassis. Disconnect the vehicle's electrical connection from the tractor before welding on the parts. It is recommended that you disconnect the tractor as well. Connect the minus (-) end of the welding machine as close as possible to the welded part in order to ensure sufficient contact with the part to be welded. Do not connect the negative (-) end to the bracket holders or the axle. Take care that welding sparks or slags do not fall on the bellows, air hoses, bracket holders etc.

Do not make any welding interventions to the tankers without gas-free (gas-free cleaning process) and gas measurement results without reliable gas-free certificate. Otherwise, there will be risks of explosion, fire and work accident due to the petroleum products transported.

### 5.5.7. Spare Wheels

Keep spare tires ready for use at all times.

### 5.5.8. Considerations For the Environment

Pollution in all its forms poses a threat to the environment. To keep the pollution at a minimum, collect the waste materials carefully and dispose of them in accordance with the regulations of your country.

**ENVIRONMENT** - Disposal of the battery in an inappropriate place may harm the environment and human health. If you need to dispose of the battery, follow local regulations. If you do not know how to dispose of it, take it to the most appropriate service point. The symbol on the battery indicates that this product should not be disposed of.



### Health and Safety

- Keep sparks and fire away from the battery. The battery emits explosive gas that can cause an explosion.
- Wear eye protection and rubber gloves while working on the battery, otherwise the battery hand-control may cause burn and serious damage including blindness in your eyes.
- Under no circumstances allow children to handle the battery. Make sure that anyone dealing with the battery is familiar with the proper use of the battery and its hazards.
- Pay close attention to the battery electrolyte as it contains diluted sulfuric acid. Contact with your skin and eyes may cause burns or loss of eyesight.
- Carefully read and understand this manual before working on the battery. Failure to follow instructions may result in injury and vehicle damage.
- Do not use the battery if the electrolyte level is at or below the recommended level. Using the battery with a low electrolyte level can cause explosion and serious injury.

**If there are wasted oil and wasted oil contact materials in your vehicle, pay attention to the following warnings.**

When disposing of products/wastes such as used oil, hydraulic oil, do not discharge into channels, sewers, landfills, or soil. This is against the legislation of all countries.

This rule also applies to empty containers in contact with oil, chemical materials, and waste of cleaning cloths. Take these wastes to the relevant authorities or the most appropriate service point for disposal.

**If your vehicle tire has expired;**

The end-of-life tire must be disposed of in accordance with the regulations. For this, take your expired tire to the relevant authorities or appropriate service points.

**If you carry dangerous chemicals in your vehicle;**

In case of an accident or emergency that may occur during transportation, act in accordance with the Written Instructions of the ADR Legislation.

From the trailer's life-cycle perspective, it is important to recycle the end-of-life vehicle in an environmentally friendly manner. A large part of the trailer consists of recyclable materials. Contact the approved company and appropriate service for the recycling of the trailer that has expired.

**5.6. Cleaning of the Vehicle**



**After transporting certain materials which are dangerous to human health, it is too risky for health to enter to the tank for cleaning. Only enter to the tank if it is absolutely necessary. Before entering to the tank, perform a gas measurement according to the applicable regulations.**

Make sure the tanker vehicle is clean by checking it on a daily basis.

These controls should be applied especially to couplings and to equipment used for loading and discharging. Dirt and product residues should be cleaned immediately.

Warning signs, reminders and sticky labels should be kept clean.

Damaged and invisible signs and labels should be replaced as soon as possible.



**Make sure that the tanker is cleaned by authorized services and cleaning firms that are specialists on cleaning the tankers.**

**Before Cleaning the Tanker Vehicle:**

- Make sure that the tank has been fully discharged and that there is no product residue left in the fittings, couplings and hoses.
- Make sure that the tank is depressurized,
- Make sure that potential conductors are connected.



**Product residue can mix into the air line. Product residues mixed in the air lines can cause products that are subsequently loaded to become sticky or contaminated, which can cause considerable material damage. Depending on the products loaded, the air lines should be cleaned.**



**Incompatible cleaning agents can damage the tank and its sealants. Only cleaning agents that are compatible with the tank and its sealants should be used.**

**Air Lines:**

- If the air lines are also to be cleaned, all the valves must be opened before cleaning begins.



When a tank that has been hot-cleaned cools down, vacuum damage can occur if the tank is insufficiently vented. Make sure that there is sufficient ventilation via the man-holes and valves.



Do not use the inflammable liquid or toxic substance for cleaning works.

### External Cleaning



Newly painted surfaces can only be cleaned after a 4-week paint stiffening period. Cleaning done before this can damage the paint. During the first 4 weeks, the tanker vehicle should only be washed with cold water jet. Do not use pressurized water jets or hard brushes.



After 4 weeks: Washing painted surfaces with high-temperature water or abrasive cleaning materials may damage the paint.

- Wash the external of the tank only with water at a temperature below 60°C.
- Do not use abrasive cleaning detergents.
- Maintain the minimum distance required when using high-pressure water jet.

### When cleaning the external of the vehicle:

- Clean the outpouring load as soon as possible.
- Clean the residues of road salts regularly, as soon as possible.
- Clean the tanker vehicle once a week with a little water and a mild, non-corrosive detergent.

### If you are cleaning with high pressure:

- Maintain minimum distance of 70 cm between the circular nozzle and the surface being cleaned.
- Maintain minimum distance of 30 cm between the flat nozzle and the surface being cleaned.
- Keep 30 cm distance.
- Do not direct water on electrical components, receptacle connections, seal rings or hoses.



Do not use the inflammable liquid or toxic substance for cleaning works.

## 6. TRANSPORTATION SOLUTION

### 6.1. Dangerous Goods Transportation (ADR)

Vehicles carrying dangerous goods should keep this plate in open position while driving. It is located at the rear of the vehicle, but its exact location may vary according to the construction of the vehicle. Approved vehicles in accordance with ADR legislation must have an ADR identification plate.

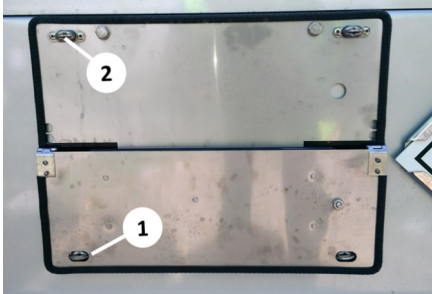

Opening ADR plate



ADR plate latches

**Opening the plate:** Open the plate in the closed position upwards by turning the latch (1) clockwise or counterclockwise by 90°, attach the opened flap of the plate to the latch (2) on the other side and fix it in the same way as the opening procedure.



**Dangerous substances that can be transported in the vehicle vary according to the vehicle structure and options. For this reason, make sure that the loads that comply with the regulations and your vehicle type are carried.**

### 6.2. Transportation Compliant with ATP Legislation

Our vehicles may have been manufactured in accordance with the ATP legislation in order to preserve the quality and improve the conditions of perishable foodstuffs, especially during international trade.

If your vehicle has an ATP certificate, there are labels showing the expiry date of the ATP certificate on the upper front of the side panel.



ATP Plate

If your vehicle complies with the ATP certificate, you can get a manufacturer's declaration by contacting authorized services.



**Any modification to the vehicle body may cause your vehicle to fall outside the scope of ATP legislation.**

### 6.3. Chemical Substance Transportation

The tank of the chemical tanker vehicle is made of stainless steel.

It is the customer's responsibility to carry the product in accordance with the

stainless steel sheet quality specified in the contracts.

After insulating the tank with glass wool, it is covered with aluminum or stainless steel sheet.

There are breakwaters in the tank to prevent the material from fluctuating. These breakwaters prevent the product from being displaced during sudden braking

or starting up, preventing the vehicle's center of gravity from shifting to a large extent. A change in the vehicle's center of gravity can affect the braking distance, handling and control of the vehicle.

Be careful to walk on the walkway when you get on the tank for the filling process or any reason. The coated outer surface of the tank can be easily damaged.

## 7. LOADING AND LOAD SECURITY

### 7.1. Loading and Discharging of Bitumen (Tar) Tanker

#### 7.1.1. Safety Instructions

- Be sure that the cargo is properly distributed and in accordance with all laws, rules, and regulations. Check the loading limits, total weight, and axle load capacities. Do not exceed the weight limits which are defined in the user manual and identification plate. Comply with all national/international laws, rules and regulations about loading and occupational safety.
- While all vehicles are being designed, except for ones, it is assumed that the load will be distributed evenly on the load carriage surface and the calculations are done accordingly. Thus, the load up to the maximum carrying capacity of your vehicle must be distributed to ensure that equal weights are at the unit areas over the utilized carriage area.
- During the loading operation, do not exceed the permissible maximum height. A loading performed within the specified loading limit will ensure that you keep away from traffic accidents.

#### Perform the following checks after loading and unloading:

- Check that the tanker is properly filled (filling level, load distribution, etc.)
- All valves and manhole covers are closed and secured.
- All material hoses are safely removed.
- Check that the folding ladder and handrail are folded and secured.

- All danger signs are in place and visible.
- In addition to these checks, some of the equipment in the vehicle must also be checked in their manufacturer's manual.

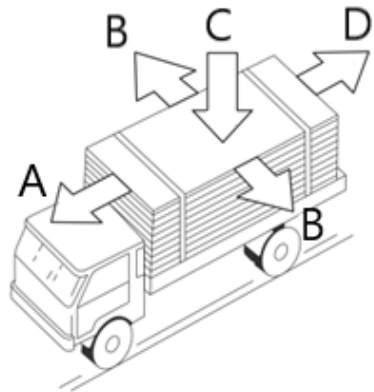
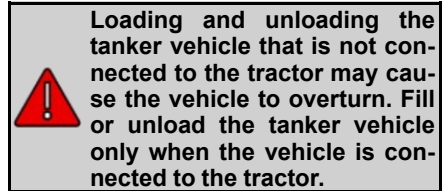

*Forces may affect the vehicle*

#### 7.1.1.1. Load Safety

The international Highways Regulations specify the maximum loading capacities of tractors, trucks, trailers, semi-trailers along with how and how much of the tonnage and dimensions of these loads are to be secured.

#### 7.1.2. Load Distribution and Load Limits of Tractor-Semi-trailer Combination

- Ensure that you made a proper load distribution in compliance with all laws, rules, and regulations.
- In the loading process, take the loading limits, total weight, and axle load capacities into the account.

- Ensure that you have performed the loading in compliance with the laws and regulations of all countries where you drive the vehicle.

The axle loads of the tractor/semi-trailer combination may vary in a broad range in relation to the various loading conditions. Comply with the permissible axle loads specified in the operation manual or the axle manufacturer's manual.

Whenever you are in doubt, have your loads checked at a proper weighing station.

**\*Axle load: This is the load conveyed by an axle or an axle group.**

- Loading and unloading of the tanker vehicle that is not connected to the tractor may cause the vehicle to tip over.
- Fill or empty the tank only when the vehicle is connected to the tractor.



**Follow the correct order during the filling and unloading operations. This is especially important if several loading sections are being filled at the same time. Even when filling, consider the unloading sequence so you can get to the unloading area with the right load distribution.**



**If the front or rear of the tank is heavy, the driving and braking characteristics of the tanker vehicle deteriorate and an accident risk arises.**

- Fill the tank evenly.
- Observe the permitted tanker and axle loads.
- Pay attention to the minimum and maximum filling levels.

**7.1.3. Loading Preparation**

Keep available and wear the appropriate protective equipment, depending on the

material to be loaded. Follow ADR regulations and material safety instructions.

Depending on the previous load that was transported, get the tanker vehicle properly cleaned before you make a new loading.

Only get onto the tank when the folding handrail is raised and if the vehicle is secured against accidental movement.

- The handbrake of the vehicle must be engaged.
- The vehicle must be level.

**Before loading, make sure of the following:**

- Check the shipper's safety precautions,
- Check to see that all the copu-lings are secure,
- Make sure of the compatibility of the product that is to be loaded with the materials of the vehicle and its seals.



**Product residues in the tank can contaminate the products in the subsequent loading and makes them unusable. Clean inside the tank if they get dirty.**

You can fill any load that is permitted for the chemical tanker vehicle via manholes from top.



**If you loosen or tighten the manholes under pressure, the manhole can tear away explosively from the tank and hit you or other people. Never attempt to open the clamps of a pressurized manhole.**

**7.1.4. Loading**

1. Draw near the filling station. Stop the vehicle. Engage the tractor handbrake.

2. Provide necessary safety on the surroundings before starting the filling process.

3. Perform grounding process with the help of grounding pins (1) on the right and left sides of vehicle.

4. Before climbing the vehicle ladder to the manhole area, open the guardrails so that the parking brakes are activated and the vehicle is secured against unintentional movement. (See section **“Components and Use of Upperstructure”**)

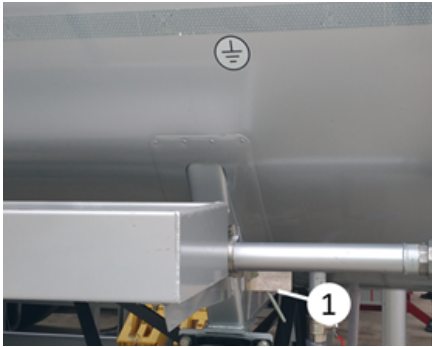

Grounding pin

5. Open the manhole cover (2). (See section **“Components and Use of Upperstructure”**).

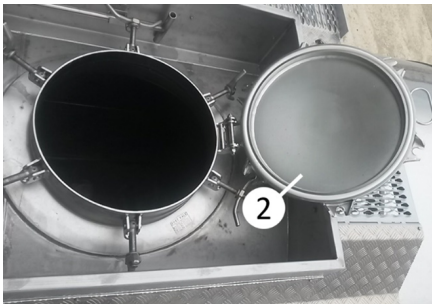

Manhole cover

6. Insert the hoses in the station, inside the manhole.

7. Vehicle is ready for filling from top.

8. Avoid overfilling and fill each compartment max. to its NET volume.

9. Close manhole cover after the tank is filled.

10. Step down from ladder and close the handrails carefully.

11. Remove the groundings lines.

12. Vehicle is ready to drive.

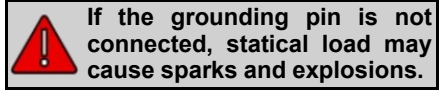

Connect the grounding pin while filling and discharging processes.

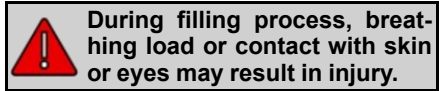

- Avoid physical contact with load. Do not breathe the steam that comes out.
- Use protective equipment according to the type of load.
- If the load causes an injury, contact to material safety document for necessary emergency measures.

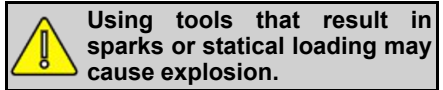

- Smoking, using cellular phones or cameras, approaching with fire or open flames are forbidden during filling process.
- Do not use spark producing tools during filling or preparation period.
- Always connect grounding pins during filling or discharging of tank.
- Do not use inappropriate mobile phone - camera in operation.



**Emergency buttons are push type. When pressed, it stops filling or discharging in an emergency.**

### 7.1.5. Discharge

#### 7.1.5.1. Compressed Air Discharge

**Compressed air discharge:** Emptying the tanker vehicle with the help of compressed air. The compressed air is supplied from an external or on board compressor.

When selecting an unloading procedure, please take the following factors into account:

- Product type and characteristics
- On-site conditions
- Climate characteristics

#### Preparing to discharge

- Park the vehicle on a firm, even ground.
- Lower the landing legs of the vehicle and get it in a level position horizontally.
- Deflate the air suspension of the tractor and trailer.
- Check that all the manhole cover and connections are closed.
- Connect the air battery to the compressor via the side air line (1).



**For using instructions of the compressor, see the manufacturer's user's manual.**

1. Draw near the filling station. Stop the vehicle.

2. Provide necessary safety on the surroundings before starting the filling process.

3. Perform grounding process with the help of grounding pins (1) on the right and left sides of vehicle.

4. Supply air to the system by connecting the side air line (1) of the vehicle to the compressor.



*Side air line*

5. Connect the discharge hose of the station to the discharge port of the vehicle with the necessary equipment (adapter etc.).

6. After making the necessary controls (system pressure, material temperature, etc.), open the valve on the side air line and supply air to the top air line (2). (See section "**Components and Use of Upperstructure**")



*Top air line*



If you open the manholes or loading connections while the tank is under pressure, these equipment may explode. In this case, you and those around you can be seriously or even fatally injured.

- Before emptying, check if the tank is under pressure.
- Never try to open manholes or loading connections while the tank is under pressure.
- Always make sure the tank is depressurized.

7. Open the bottom valve (3) (See section “**Components and Use of Upperstructure**”).

8. Apply also jet air (4) and supply material flow from discharge port (5).

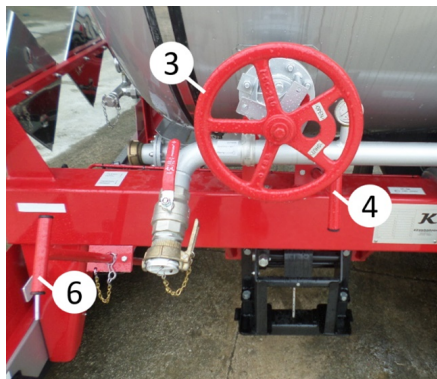

Bottom valve, jet air, rapid shut off valve

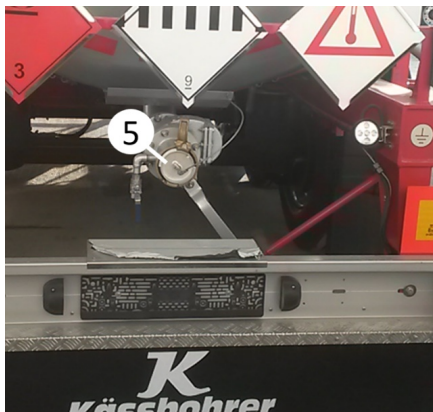

Discharge port

9. In emergency conditions and when necessary, you can stop the material flow using rapid shut off valve (6). Jet air system provides supplying and stopping of jet air (For the operation of both systems, see section “**Components and Use of Upperstructure**”).

10. After the discharge of the material is completed, take off the material residuals inside the bend with free blowing mechanism.

11. Close bottom valve and jet air. Close top air line.

12. Stop the compressor.

13. After the connections between the station and the vehicle are removed, the vehicle is ready for drive.



**Material transported in the bitumen tanker is hot material. During filling and discharge processes, be careful against burning hazard.**

- Avoid direct contact with transported material.
- Do not forget to wear suitable protective clothes during filling and discharge processes.

### 7.1.5.2. Free Discharge

Keep available and wear the appropriate protective equipment, depending on the material to be discharged. Follow ADR regulations and material safety instructions.

Only get onto the tank when the folding handrail is raised and if the vehicle is secured against accidental movement.

- The handbrake of the vehicle must be engaged.
- The vehicle must be level.

The following operation can be used to unload the tanker vehicle:

- Free discharge (floor discharge):  
Discharging without the use of auxiliary equipment. The free discharge of the product to the ground by the effect of gravity.

 **When free discharge (by gravity, without giving compressed air into the tank), one of the manhole covers must be opened before starting the discharge.**

1. Draw near the filling station. Stop the vehicle.
2. Provide necessary safety on the surroundings before starting the discharging process.
3. Connect the discharge hose of the station to the discharge port (1) of the vehicle with the necessary equipment (adapter etc.).
4. Open the handrails before climbing the vehicle ladder to the manhole area.
5. After making the necessary controls (system pressure, material temperature, etc.), open the filling manhole cover on the tank (See section "**Components and Use of Upperstructure**").
6. Open the bottom valve (1) (See section "**Components and Use of Upperstructure**").



*Handwheel bottom valve*

7. Open the rapid shut off valve and allow the material to flow through the discharge port (2).



*Discharge port*

8. In emergency conditions and when necessary, you can stop the material flow using rapid shut off valve (3). (See section "**Components and Use of Upperstructure**").

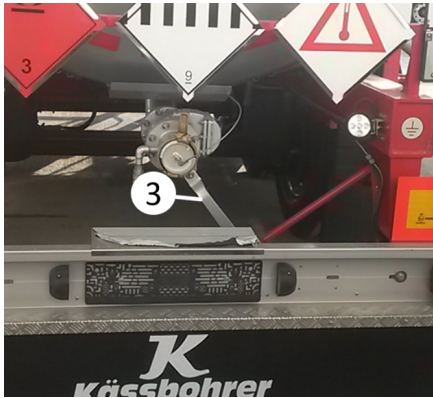

*Rapid shut off valve*

9. Close bottom valve. Close manhole cover.

10. After the connections between the station and the vehicle are removed, the vehicle is ready for drive.

### 7.1.5.3. Warnings for Filling and Discharging Operations

- Park the vehicle to the station so that discharge connections shall be short as much as possible. Thus, the possibility of tangling or bending of the hoses is minimized.
- Stop the engine and apply the park brake when you stop the vehicle. Place chocks to the wheels if required.
- Before and during filling operation, follow the safety instructions of the transporter.
- Do not smoke !
- To prevent the risk of explosion, turn off any electrical appliances that are not used. These include the radio, cell phones and auxiliary heaters. Headlamps of the vehicle are unnecessary, too.
- Avoid conducting shoes and hard hats, wear additional protective clothes, too, if required.

- Do not carry items that may cause sparks (keys, lighters, etc.) in the pockets of the clothes. Do not wear clothes that may cause static electricity during operation.
- Do not attempt to thaw frozen manhole covers with open flames.
- Check if all connections are in place and secure before any filling and discharging operation.

### 7.1.5.4. Checks After Loading and Unloading

Perform the following checks after loading and unloading:

- Ensure that the tanker is properly filled (filling level, load distribution, etc.).
- All valves and manhole covers are closed and secured.
- All material hoses are safely removed.
- All danger signs are in place and visible.

In addition to these controls, some of the equipment in the vehicle must also be checked in the manufacturer's manual.

## 7.2. Loading and Discharging of Chemical Tanker

### 7.2.1. Safety Instructions

- Be sure that the cargo is properly distributed and in accordance with all laws, rules, and regulations. Check the loading limits, total weight, and axle load capacities. Do not exceed the weight limits which are defined in the user manual and identification plate. Comply with all national/international laws, rules and regulations about loading and occupational safety.
- While all vehicles are being designed, except for ones, it is assumed that the load will be

distributed evenly on the load carriage surface and the calculations are done accordingly. Thus, the load up to the maximum carrying capacity of your vehicle must be distributed to ensure that equal weights are at the unit areas over the utilized carriage area.

- During the loading operation, do not exceed the permissible maximum height. A loading performed within the specified loading limit will ensure that you keep away from traffic accidents.

Perform the following checks after loading and unloading:

- Check that the tanker is properly filled (filling level, load distribution, etc.)
- All valves and manhole covers are closed and secured.
- All material hoses are safely removed.
- Check that the folding ladder and handrail are folded and secured.
- All danger signs are in place and visible.
- In addition to these checks, some of the equipment in the vehicle must also be checked in their manufacturer's manual.

 **Loading and unloading the tanker vehicle that is not connected to the tractor may cause the vehicle to overturn. Fill or unload the tanker vehicle only when the vehicle is connected to the tractor.**

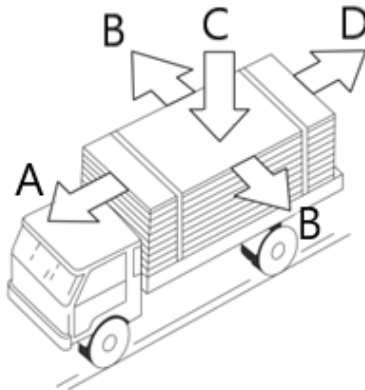

*Forces may affect the vehicle*

- A- Brake Force
- B- Centrifugal Force
- C- Static Weight Force
- D- Ramp / Hill Force

 **When filling the material, if the filling is done too close to the front or the rear, or if the tank is overfilled, the driving and braking characteristics of the vehicle will deteriorate. This poses a great risk.**

- Fill the material as evenly as possible.
- Observe the permissible tank and axle loads.
- Pay attention to the minimum and maximum filling levels.

#### **7.2.1.1. Load Safety**

The international Highways Regulations specify the maximum loading capacities of tractors, trucks, trailers, semi-trailers

along with how and how much of the tonnage and dimensions of these loads are to be secured.

### 7.2.2. Load Distribution and Load Limits of Tractor-Semi-trailer Combination

- Ensure that you made a proper load distribution in compliance with all laws, rules, and regulations.
- In the loading process, take the loading limits, total weight, and axle load capacities into the account.
- Ensure that you have performed the loading in compliance with the laws and regulations of all countries where you drive the vehicle.

The axle loads of the tractor/semi-trailer combination may vary in a broad range in relation to the various loading conditions.

Comply with the permissible axle loads specified in the operation manual or the axle manufacturer's manual.

Whenever you are in doubt, have your loads checked at a proper weighing station.

**\*Axle load: This is the load conveyed by an axle or an axle group.**

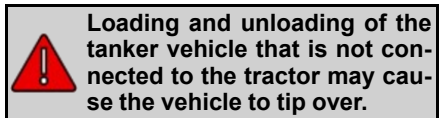

- **Fill or empty the tank only when the vehicle is connected to the tractor.**

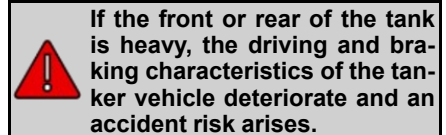
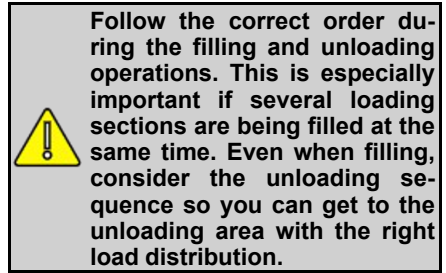

- **Fill the tank evenly.**
- **Observe the permitted tanker and axle loads.**
- **Pay attention to the minimum and maximum filling levels.**

### 7.2.3. Loading Preparation

Keep available and wear the appropriate protective equipment, depending on the material to be loaded. Follow ADR regulations and material safety instructions.

Depending on the previous load that was transported, get the tanker vehicle properly cleaned before you make a new loading.

Only get onto the tank when the folding handrail is raised and if the vehicle is secured against accidental movement.

- The handbrake of the vehicle must be engaged.
- The vehicle must be level.

**Before loading, make sure of the following:**

- Check the shipper's safety precautions,
- Check to see that all the couplings are secure,

- Make sure of the compatibility of the product that is to be loaded with the materials of the vehicle and its seals.

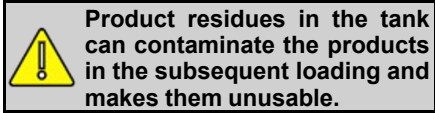

- Clean inside the tank if they get dirty.

You can fill any load that is permitted for the bitumen tanker vehicle via manholes from top.

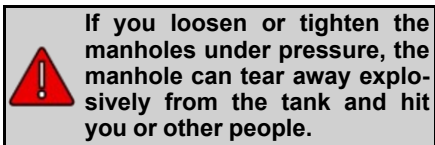

- **Never attempt to open the clamps of a pressurized manhole.**

#### 7.2.4. Loading

1. Draw near the filling station. Stop the vehicle. Engage the tractor handbrake.
2. Provide necessary safety on the surroundings before starting the filling process.
3. Perform grounding process with the help of grounding pins (1) on the right and left sides of vehicle.
4. Before climbing to the manhole area by vehicle ladder, open the guardrails. (See section “**Components and Use of Upperstructure**”)

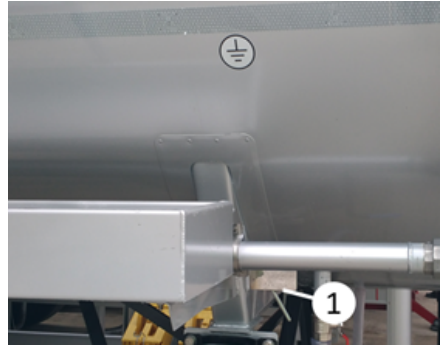

*Grounding pin*

5. Open the manhole cover (2). (See section “**Components and Use of Upperstructure**”)

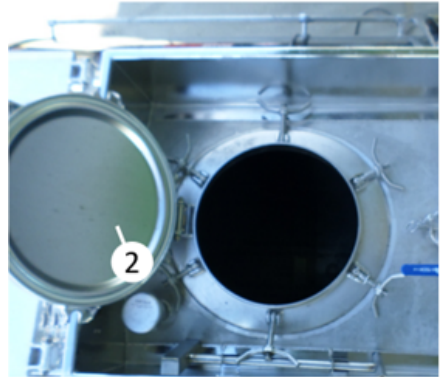

*Manhole cover*

6. Insert the hoses in the station, inside the manhole.
7. Vehicle is ready for filling from top.
8. Avoid overfilling and fill each compartment max. to its NET volume.
9. Close manhole cover after the tank is filled.
10. Step down from ladder and close the handrails carefully.
11. Remove the groundings lines.
12. Vehicle is ready to drive.



If the grounding pin is not connected, statical load may cause sparks and explosions.

- Connect the grounding pin while filling and discharging processes.



During filling process, breathing load or contact with skin or eyes may result in injury.

- Avoid physical contact with load. Do not breathe the steam that comes out.
- Use protective equipment according to the type of load.
- If the load causes an injury, contact to material safety document for necessary emergency measures.



Using tools that result in sparks or statical loading may cause explosion.

- Smoking, using cellular phones or cameras, approaching with fire or open flames are forbidden during filling process.
- Do not use spark producing tools during filling or preparation period.
- Always connect grounding pins during filling or discharging of tank.
- Do not use inappropriate mobile phone - camera in operation.



Emergency buttons are push type. When pressed, it stops filling or discharging in an emergency.

compressed air. The compressed air is supplied from an external or on board compressor.

When selecting an unloading procedure, please take the following factors into account:

- Product type and characteristics
- On-site conditions
- Climate characteristics

### Preparing to discharge

- Park the vehicle on a firm, even ground.
- Lower the rear landing legs of the vehicle and get it in a level position horizontally.
- Deflate the air suspension of the tractor and trailer.
- Check that all the manhole cover and connections are closed.
- Connect the air battery to the compressor via the side air line (1).



For using instructions of the compressor, see the manufacturer's user's manual.

1. Draw near the filling station. Stop the vehicle.
2. Provide necessary safety on the surroundings before starting the filling process.
3. Perform grounding process with the help of grounding pins (1) on the vehicle.

## 7.2.5. Discharge

### 7.2.5.1. Compressed Air Discharge

**Compressed air discharge:** Emptying the tanker vehicle with the help of

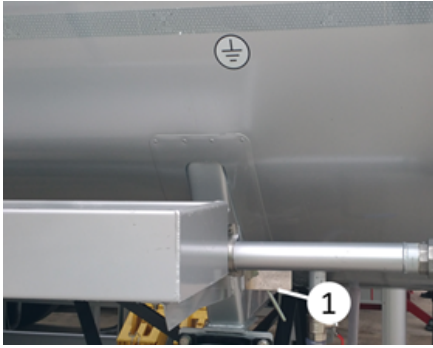

Grounding pin

4. Supply air to the system by connecting the side air line (2) of the vehicle to the compressor.



Side air line

5. Connect the discharge hose of the station to the discharge port (3) of the vehicle with the necessary equipment (adapter etc.).

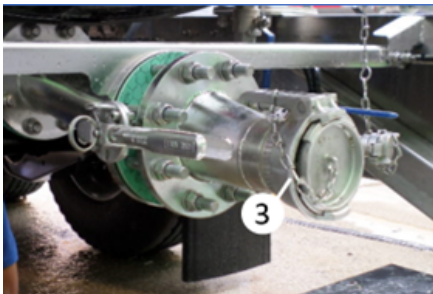

Discharge port

6. After making the necessary controls (system pressure, material temperature, etc.), open the valve on the top air line and supply air to the top air line (4). (See

section “**Components and Use of Upperstructure**”).

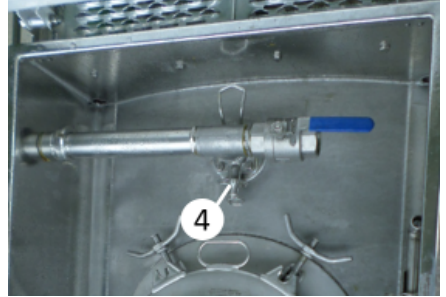

Top air line ball valve

7. Open the bottom valve (5) (See section “**Components and Use of Upperstructure**”).

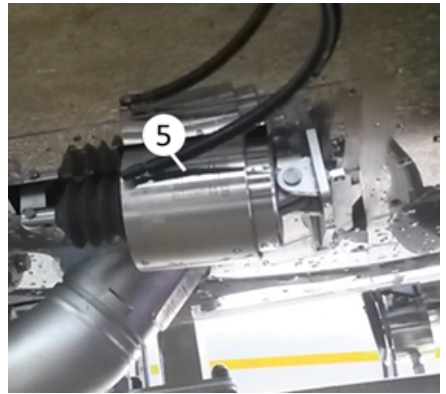

Pneumatic actuator

8. Start the flow by opening the safety valve (6). (See section “**Components and Use of Upperstructure**”).

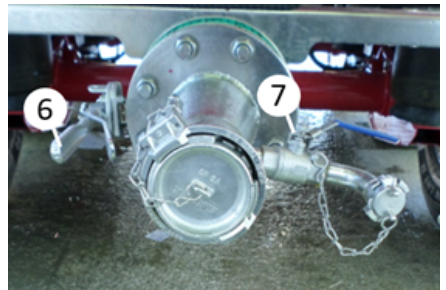

Safety valve and free blowing mechanism

9. After the discharge of the material is completed, take off the material residuals inside the bend with free blowing mechanism (7) (See section “**Components and Use of Upperstructure**”).

10. Close bottom valve and free blowing mechanism when discharge is complete.

11. Stop the compressor.

12. Discharge the compressed air remaining in the tank by opening the ball valve (8) on the top air line. Then close the valves (4,8) in the top air line (See section “**Components and Use of Upperstructure**”).

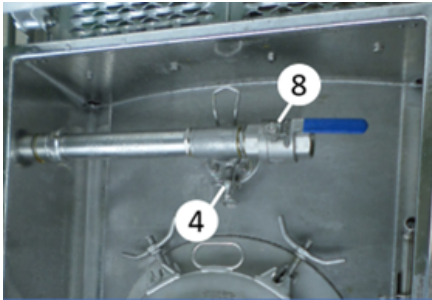

*Top air line ball valve*

13. Close the safety valve, disconnect the connections and grounding lines between the station and the vehicle. The vehicle is ready for drive.



**The pressure discharge method is not suitable for discharging flammable liquids with a flash point below 61°C. Because the compressed air is hot, it can cause an explosion.**

#### 7.2.5.2. Discharge With Pump

1. Draw near the filling station. Stop the vehicle.

2. Provide necessary safety on the surroundings before starting the filling process.

3. Perform grounding process with the help of grounding pins (1) on the vehicle.

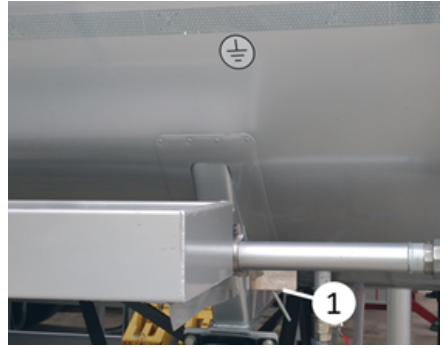

*Grounding pin*

4. Connect the hydraulic pressure and return hoses to the hydraulic couplings (2,3) located at the front of the vehicle.

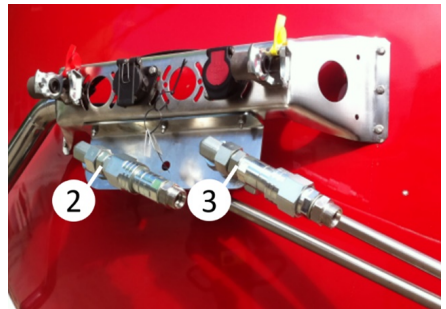

*Hydraulic couplings*

5. Connect the discharge hose of the discharge station with the necessary equipment (adapter, etc.) to the connection coupling (4) in front of the pump outlet line.

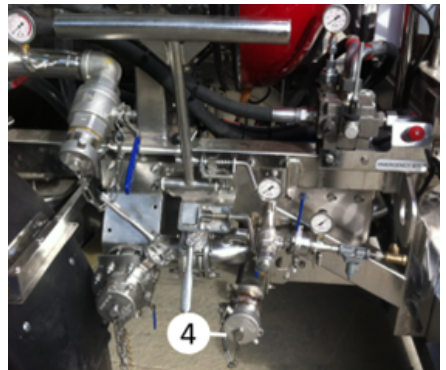

*Connection coupling*

6. Open bottom valve (5) (See section “**Components and Use of Upperstructure**”).

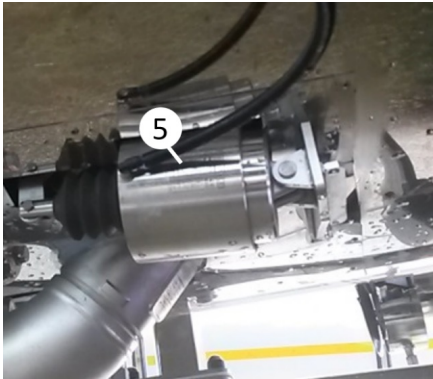

*Pneumatic actuator*

7. Open the butterfly valve (6) on the pump inlet line.

8. Open the hydraulic control valve (7).

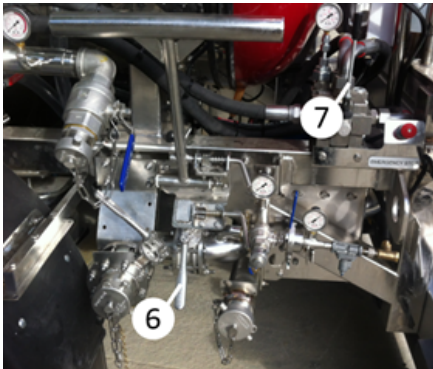

*Butterfly valve, hydraulic control valve*

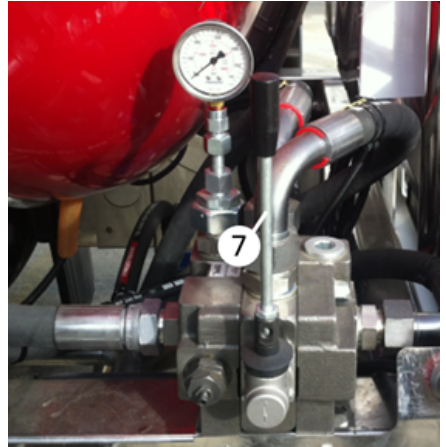

*Hydraulic control valve*

9. Close the hydraulic valve after the discharging process is complete.

10. Close bottom valve.

11. Remove the connections between the station and the vehicle.

12. After removing the grounding lines, the vehicle is ready for drive.

### **7.2.5.3. Free Discharge**

Keep available and wear the appropriate protective equipment, depending on the material to be discharged. Follow ADR regulations and material safety instructions.

Only get onto the tank when the folding handrail is raised and if the vehicle is secured against accidental movement.

- The handbrake of the vehicle must be engaged.
- The vehicle must be level.

The following operation can be used to unload the tanker vehicle:

- Free discharge (floor discharge): Discharging without the use of auxiliary equipment. The free discharge of the product to the ground by the effect of gravity.



**When free discharge (by gravity, without giving compressed air into the tank), one of the manhole covers must be opened before starting the discharge.**

1. Draw near the filling station. Stop the vehicle.
2. Provide necessary safety on the surroundings before starting the discharging process.
3. Perform grounding process with the help of grounding pins on the vehicle.
4. Connect the discharge hose of the station to the discharge port of the vehicle with the necessary equipment (adapter etc.).
5. After making the necessary controls (system pressure, material temperature, etc.), open the filling manhole cover on the tank (See section "**Components and Use of Upperstructure**").
6. Open the bottom valve (1) (See section "**Components and Use of Upperstructure**").

#### *Pneumatic actuator*

7. Start the flow by opening the safety valve (2). (See section "**Components and Use of Upperstructure**").

#### *Safety valve*

8. Close the bottom valve after discharging. Close the manhole cover.
9. After the connections between the station and the vehicle are removed, the vehicle is ready for drive.



**The material transported in the tanker may be hot. During the filling and discharging processes, care must be taken against the danger of burning.**

- **Avoid direct contact with the transported material.**
- **Do not forget to wear suitable protective equipment during filling and discharging operations.**



**If you open the manholes or loading connections while the tank is under pressure, these equipment may explode. In this case, you and those around you can be seriously or even fatally injured.**

- **Before discharging, check if the tank is under pressure.**
- **Never attempt to open manholes or loading connections while the tank is under pressure.**
- **Always make sure the tank is depressurized.**

### **7.2.6. Warnings for Filling and Discharging Operations**

- Park the vehicle to the station so that discharge connections shall be short as much as possible. Thus, the possibility of tangling or bending of the hoses is minimized.
- Stop the engine and apply the park brake when you stop the vehicle. Place chocks to the wheels if required.
- Before and during filling operation, follow the safety instructions of the transporter.
- Do not smoke !
- To prevent the risk of explosion, turn off any electrical appliances that are not used. These include the radio,

cell phones and auxiliary heaters. Headlamps of the vehicle are unnecessary, too.

- Avoid conducting shoes and hard hats, wear additional protective clothes, too, if required.
- Do not carry items that may cause sparks (keys, lighters, etc.) in the pockets of the clothes. Do not wear clothes that may cause static electricity during operation.
- Do not attempt to thaw frozen manhole covers with open flames.
- Check if all connections are in place and secure before any filling and discharging operation.

### **7.2.7. Checks After Loading and Unloading**

Perform the following checks after loading and unloading:

- Ensure that the tanker is properly filled (filling level, load distribution, etc.).
- All valves and manhole covers are closed and secured.
- All material hoses are safely removed.
- All danger signs are in place and visible.

In addition to these controls, some of the equipment in the vehicle must also be checked in the manufacturer's manual.

## **7.3. Loading and Discharging of Food Tankers**

### **7.3.1. Safety Instructions**

- Be sure that the cargo is properly distributed and in accordance with all laws, rules, and regulations. Check the loading limits, total weight, and axle load capacities. Do not exceed the weight limits which are defined in the user manual and

identification plate. Comply with all national/international laws, rules and regulations about loading and occupational safety.

- While all vehicles are being designed, except for ones, it is assumed that the load will be distributed evenly on the load carriage surface and the calculations are done accordingly. Thus, the load up to the maximum carrying capacity of your vehicle must be distributed to ensure that equal weights are at the unit areas over the utilized carriage area.
- During the loading operation, do not exceed the permissible maximum height. A loading performed within the specified loading limit will ensure that you keep away from traffic accidents.

Perform the following checks after loading and unloading:

- Check that the tanker is properly filled (filling level, load distribution, etc.).
- All valves and manhole covers are closed and secured.
- All material hoses are safely removed.
- Check that the folding ladder and handrail are folded and secured.
- All danger signs are in place and visible.
- In addition to these checks, some of the equipment in the vehicle must also be checked in their manufacturer's manual.



Loading and unloading the tanker vehicle that is not connected to the tractor may cause the vehicle to overturn. Fill or unload the tanker vehicle only when the vehicle is connected to the tractor.



When filling the material, if the filling is done too close to the front or the rear, or if the tank is overfilled, the driving and braking characteristics of the vehicle will deteriorate. This poses a great risk.

- Fill the material as evenly as possible.
- Observe the permissible tank and axle loads.
- Pay attention to the minimum and maximum filling levels.

#### 7.3.1.1. Load Safety

The international Highways Regulations specify the maximum loading capacities of tractors, trucks, trailers, semi-trailers along with how and how much of the tonnage and dimensions of these loads are to be secured.

#### 7.3.2. Load Distribution and Load Limits of Tractor-Semi-trailer Combination



Loading and unloading of the tanker vehicle that is not connected to the tractor may cause the vehicle to tip over.

Fill or empty the tank only when the vehicle is connected to the tractor.



Follow the correct order during the filling and unloading operations. This is especially important if several loading sections are being filled at the same time. Even when filling, consider the unloading sequence so you can get to the unloading area with the right load distribution.



If the front or rear of the tank is heavy, the driving and braking characteristics of the tanker vehicle deteriorate and an accident risk arises.

- Fill the tank evenly.
- Observe the permitted tanker and axle loads.
- Pay attention to the minimum and maximum filling levels.

#### 7.3.3. Loading Preparation

Keep available and wear the appropriate protective equipment, depending on the material to be loaded. Follow ADR regulations and material safety instructions.

Depending on the previous load that was transported, get the tanker vehicle properly cleaned before you make a new loading.

Only get onto the tank when the folding handrail is raised and if the vehicle is secured against accidental movement.

- The handbrake of the vehicle must be engaged.
- The vehicle must be level.

**Before loading, make sure of the following:**

- Check the shipper's safety precautions,
- Check to see that all the couplings are secure,

- Make sure of the compatibility of the product that is to be loaded with the materials of the vehicle and its seals.

 **Product residues in the tank can contaminate the products in the subsequent loading and makes them unusable.**

**Clean inside the tank if they get dirty.**

You can fill any load that is permitted for the food tanker vehicle via manholes from top.

**7.3.4. Loading**

1. Draw near the filling station. Stop the vehicle.
2. Provide necessary safety on the surroundings before starting the filling process.
3. Before climbing to the manhole area by vehicle ladder, open the guardrails.
4. Open the manhole cover (1).

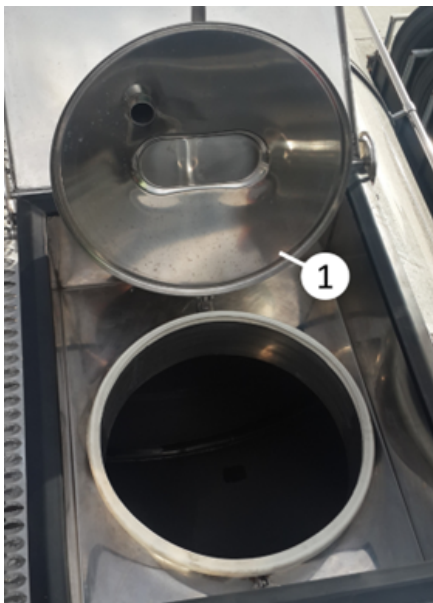

*Manhole cover*

5. Insert the hoses in the station, inside the manhole.

6. Vehicle is ready for filling.
7. Avoid overfilling and fill each compartment max. to its NET volume.
8. Close manhole cover after the tank is filled.
9. Step down from ladder and close the handrails carefully.
10. Vehicle is ready to drive.

**7.3.5. Discharge**

**7.3.5.1. Free Discharge**

Keep available and wear the appropriate protective equipment, depending on the material to be discharged. Follow ADR regulations and material safety instructions.

Only get onto the tank when the folding handrail is raised and if the vehicle is secured against accidental movement.

- The handbrake of the vehicle must be engaged.
- The vehicle must be level.

The following operation can be used to unload the tanker vehicle:

- Free discharge (floor discharge): Discharging without the use of auxiliary equipment. The free discharge of the product to the ground by the effect of gravity.

 **When free discharge (by gravity, without giving compressed air into the tank), one of the manhole covers must be opened before starting the discharge.**

1. Draw near the filling station. Stop the vehicle.
2. Provide necessary safety on the surroundings before starting the discharging process.
3. Connect the discharge hose of the station to the discharge port (1) of the

vehicle with the necessary equipment (adapter etc.).



*Discharge port, butterfly valve*

4. Open the handrails before climbing the vehicle ladder to the manhole area.

5. Open the bottom valve (2) with the handwheel on the vehicle. (See section “

*Components and Use of Upperstructure*”).

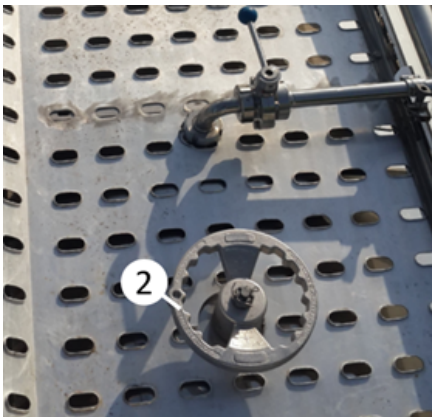

*Handwheel*

6. Open the butterfly valve (3) located at the discharge port on the side where you will discharge. (See section “

*Components and Use of Upperstructure*”).

7. Perform the discharging operation.

8. Close the bottom valve and the butterfly valves.

9. Step down from ladder and close the handrails carefully.

10. After the connections between the station and the vehicle are removed, the vehicle is ready for drive.

### **7.3.5.2. Compressed Air Discharge**

**Compressed air discharge:** Emptying the tanker vehicle with the help of compressed air. The compressed air is supplied from an external or on board compressor.

When selecting an unloading procedure, please take the following factors into account:

- Product type and characteristics
- On-site conditions
- Climate characteristics

#### **Preparing to discharge**

- Park the vehicle on a firm, even ground.
- Lower the rear landing legs of the vehicle and get it in a level position horizontally.
- Deflate the air suspension of the tractor and trailer.
- Check that all the manhole cover and connections are closed.
- Connect the air battery to the compressor via the side air line (1).

 **For using instructions of the compressor, see the manufacturer's user's manual.**

1. Draw near the filling station. Stop the vehicle.

2. Provide necessary safety on the surroundings before starting the filling process.
3. Connect the discharge hose of the station to the discharge port (1) of the vehicle with the necessary equipment (adapter etc.).



Discharge port, butterfly valve

4. Before climbing the vehicle ladder to the manhole area, open the guardrails.
5. Open the bottom valve (2) with the handwheel on the vehicle. (See section “**Components and Use of Upperstructure**”).

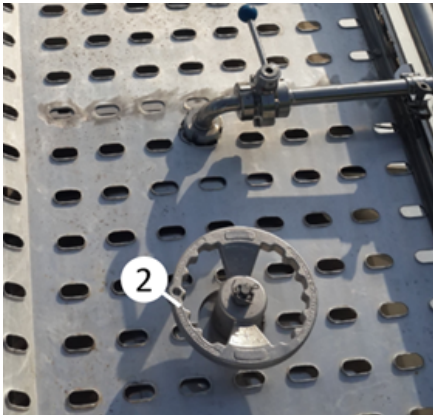

Handwheel

6. Open the butterfly valve (3) located at the discharge port on the side where you will discharge. (See section “**Components and Use of Upperstructure**”).

### Starting discharge

1. For pressure discharge, firstly 2" TW coupling, 2" check valve, DN50 stainless line starts from the right front, rises from the back of the 1st manhole to the top of the tank and enters the tank in the 1st manhole area. The other line continues from the rear of the vehicle, extends to the right of the vehicle and goes down the rear right and ends in the armature cabinet.

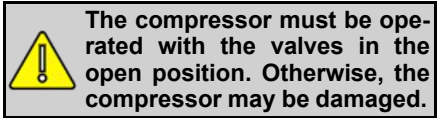

2. Connect the compressor connection to the front of side air line (4).



Side air line

3. Start the compressor.
4. The pressure inside the tanker vehicle increases gradually.

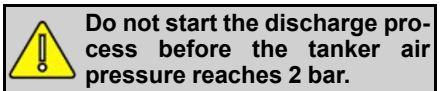

5. By checking the tank pressure visually from the manometer, the discharge process can start when the value approaches 2 bar.



**When the tanker air pressure exceeds 2 bar, the safety valve automatically evacuates the excess air.**

6. After the discharge process is finished, first disconnect the air line from the compressor.

7. Close the bottom valve and butterfly valves.

8. Step down from ladder and close the handrails carefully.

9. After the connections between the station and the vehicle are removed, the vehicle is ready for drive.

### **7.3.6. Warnings for Filling and Discharging Operations**

- Park the vehicle to the station so that discharge connections shall be short as much as possible. Thus, the possibility of tangling or bending of the hoses is minimized.
- Stop the engine and apply the park brake when you stop the vehicle. Place chocks to the wheels if required.
- Before and during filling operation, follow the safety instructions of the transporter.
- Do not smoke !
- Do not attempt to thaw frozen manhole covers with open flames.
- Check if all connections are in place and secure before any filling and discharging operation.

### **7.3.7. Checks After Loading and Unloading**

Perform the following checks after loading and unloading:

- Ensure that the tanker is properly filled (filling level, load distribution, etc.).

- All valves and manhole covers are closed and secured.
- All material hoses are safely removed.
- All danger signs are in place and visible.

In addition to these controls, some of the equipment in the vehicle must also be checked in its manufacturer's manual.

### **7.3.8. STL Pumped Discharge**

Open the pump outlet blind cap for discharge and connect the discharge hose.



*Pump Outlet Blind Cap*

Pull the K button and open the bottom valves of the compartment to be discharged (Example: Compartment 1).

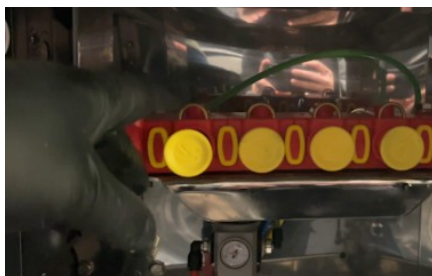

*K Button*

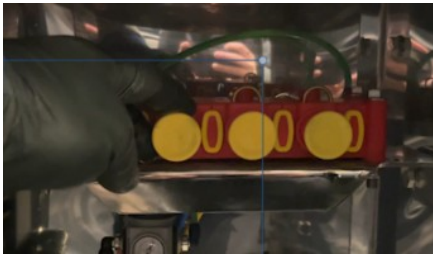

Turn on the switch to activate the pump control panel.



*Switch*

To perform the discharge, open the pump manifold butterfly valves. (For example, if Compartment 1 is to be discharged, open the pump manifold butterfly valves of Compartments 3 and 2.)



*Pump Butterfly Valve*

Set the Compartment 1 butterfly valve and the Compartment 1 pump valve to the open position.



Press the Start button to run the pump.



*Start*

Press the Unload button to start the discharge.



*Unload*

The pump speed is increased using the direction button.



*Direction Button*

## 7.4. Loading and Discharging of Waste Tankers

### 7.4.1. Safety Instructions

- Be sure that the cargo is properly distributed and in accordance with all laws, rules, and regulations. Check the loading limits, total weight, and axle load capacities. Do not exceed the weight limits which are defined in the user manual and identification plate. Comply with all national/international laws, rules and regulations about loading and occupational safety.

- While all vehicles are being designed, except for ones, it is assumed that the load will be distributed evenly on the load carriage surface and the calculations are done accordingly. Thus, the load up to the maximum carrying capacity of your vehicle must be distributed to ensure that equal weights are at the unit areas over the utilized carriage area.
- During the loading operation, do not exceed the permissible maximum height. A loading performed within the specified loading limit will ensure that you keep away from traffic accidents.

Perform the following checks after loading and unloading:

- Check that the tanker is properly filled (filling level, load distribution, etc.)
- All valves and manhole covers are closed and secured.
- All material hoses are safely removed.
- Check that the folding ladder and handrail are folded and secured.
- All danger signs are in place and visible.
- In addition to these checks, some of the equipment in the vehicle must also be checked in their manufacturer's manual.



**When filling the material, if the filling is done too close to the front or the rear, or if the tank is overfilled, the driving and braking characteristics of the vehicle will deteriorate. This poses a great risk.**

- Fill the material as evenly as possible.

- Observe the permissible tank and axle loads.
- Pay attention to the minimum and maximum filling levels.

#### **7.4.1.1. Load Safety**

The international Highways Regulations specify the maximum loading capacities of tractors, trucks, trailers, semi-trailers along with how and how much of the tonnage and dimensions of these loads are to be secured.

#### **7.4.2. Load Distribution and Load Limits of Tractor-Semi-trailer Combination**

- Ensure that you made a proper load distribution in compliance with all laws, rules, and regulations.
- In the loading process, take the loading limits, total weight, and axle load capacities into the account.
- Ensure that you have performed the loading in compliance with the laws and regulations of all countries where you drive the vehicle.

The axle loads of the tractor/semi-trailer combination may vary in a broad range in relation to the various loading conditions.

Comply with the permissible axle loads specified in the operation manual or the axle manufacturer's manual.

Whenever you are in doubt, have your loads checked at a proper weighing station.

**\*Axle load: This is the load conveyed by an axle or an axle group.**



**Loading and unloading of the tanker vehicle that is not connected to the tractor may cause the vehicle to tip over.**

- **Fill or empty the tank only when the vehicle is connected to the tractor.**



Follow the correct order during the filling and unloading operations. This is especially important if several loading sections are being filled at the same time. Even when filling, consider the unloading sequence so you can get to the unloading area with the right load distribution.



If the front or rear of the tank is heavy, the driving and braking characteristics of the tanker vehicle deteriorate and an accident risk arises.

- Fill the tank evenly.
- Observe the permitted tanker and axle loads.
- Pay attention to the minimum and maximum filling levels.

### 7.4.3. Loading

#### 7.4.3.1. Top Filling

- 1-) Draw near the filling station. Stop the vehicle. Engage the tractor handbrake.
- 2-) Fix the vehicle with the help of wheel chocks.
- 3-) Open the manhole cover (2) on the tank.

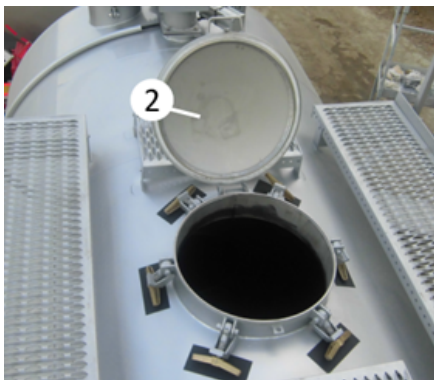

Manhole cover

4-) Insert the filling hose into the manhole and perform the filling process.

5-) Close the manhole cover after filling.

#### 7.4.3.2. Bottom Filling

- 1-) Draw near the filling station. Stop the vehicle. Engage the tractor handbrake.
- 2-) Fix the vehicle with the help of wheel chocks.
- 3-) Remove the perrot coupling cover (21).

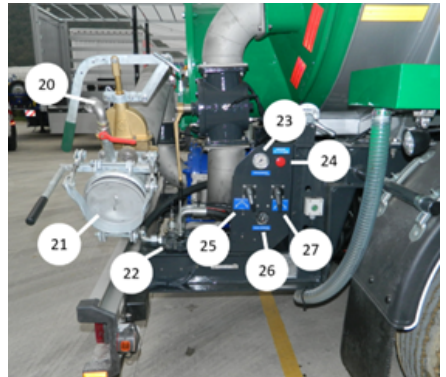

4-) Connect the perrot coupling to fill/discharge hose. Connect the other end of the hose to the coupling on the unit to be filled.

5-) Open the 6" manual control gate valve (11.1) on the pump outlet line.

6-) Close the 6" manual control gate valve (11.2) on the tank mixing pump inlet line.



*Manual control gate valve*

7-) Set the 3-Way Ball valve (15), the discharge pump inlet line (18) to the "On" position and the tank mixing pump outlet line (19) to the "Off" position.

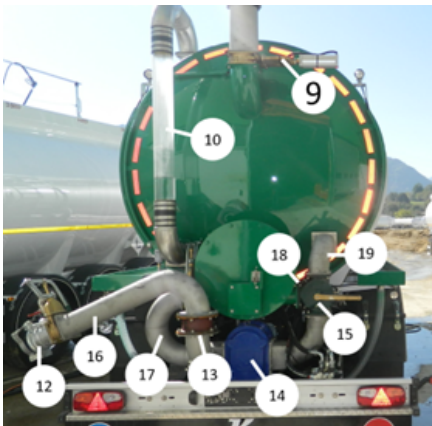

8-) Open the pneumatic valve for tank ventilation (27).

9-) Connect the hydraulic quick couplings (31) to their counterparts on the tractor.



*Hydraulic quick coupling*

10-) Activate the tractor PTO and pump oil into the system.

11-) Move the hydraulic control lever (22) to the filling position manually.

12-) Filling process starts.

13-) When the product level in the tanker increases and becomes full, the float (10) in the tank rises, the arrow at the end of the float presses the pneumatic roller valve. In this way, the hydraulic motor sends a signal to the product pump and the product pump stops.

14-) Since the product that fills in the tank is foamy on top, some more product can still be filled into the tank. In order to make this, press the pneumatic valve (24) to operate the product pump for 10 seconds and bring the hydraulic control lever to the filling position. This process should be done in max. 10 seconds, so that the tank is completely filled.

15-) After the filling process is completed, close the 6" gate valves. Remove the filling-discharging hose from the perrot coupling. Connect the perrot coupling blind cap.



The system will not allow the pump to run until the tank ventilation valve is opened. Tank ventilation valve must be opened first.

#### 7.4.4. Discharge

Discharge can be performed in three ways:

- Gravity discharge
- Discharge with pump
- Vacuum discharge from the tank rear upper funnel.



Before discharging, the product in the tank must be mixed with the help of a pump. Since the density of waste manure is high, the part that precipitates to the bottom should be mixed and easy discharge should be provided.

##### 7.4.4.1. In-Tank Mixing

1-) Open the 6" manual control gate valve (11.2) on the tank mixing pump inlet line.



Manual control gate valve

2-) Close the 6" manual control gate valve (11.1) on the pump outlet line.

3-) Set the 3-Way Ball valve (15), the discharge pump inlet line (18) to the "Off" position and the tank mixing pump outlet line (19) to the "On" position.

4-) Open the tank ventilation on-off pneumatic valve (27).

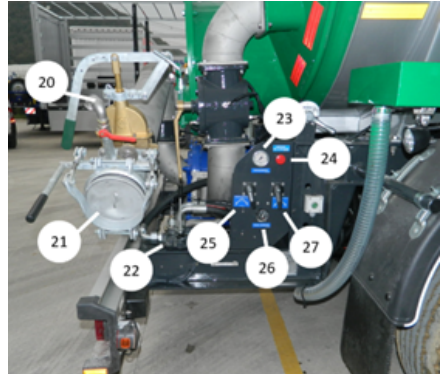

5-) Connect the hydraulic quick couplings (31) to their counterparts on the tractor.



Hydraulic quick coupling

6-) Activate the tractor PTO and pump oil into the system.

7-) Move the hydraulic control lever (22) to the discharge position manually.

8-) In this way, the product in the tank is mixed.

##### 7.4.4.2. Gravity Discharge

Keep available and wear the appropriate protective equipment, depending on the material to be discharged. Follow ADR regulations and material safety instructions.

Only get onto the tank when the folding handrail is raised and if the vehicle is secured against accidental movement.

- The handbrake of the vehicle must be engaged.
- The vehicle must be level.

The following operation can be used to discharge the tanker vehicle:

- Gravity discharge (floor discharge): Discharging without the use of auxiliary equipment. The free discharge of the product to the ground by the effect of gravity.



**When free discharge (by gravity, without giving compressed air into the tank), one of the manhole covers must be opened before starting the discharge.**

- 1-) Draw near the filling station. Stop the vehicle.
- 2-) Fix the vehicle with the help of wheel chocks.
- 3-) Remove the perrot coupling cover (21).

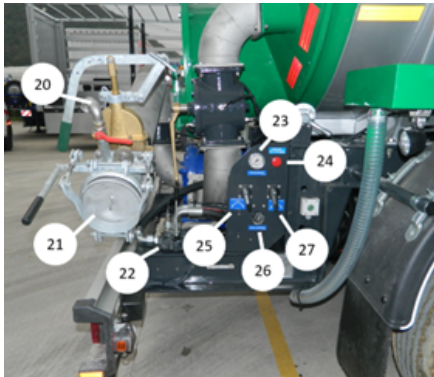

4-) Connect the perrot coupling to fill/discharge hose. Connect the other end of the hose to the coupling on the unit to be filled.

5-) Open the pneumatic on-off valve for tank ventilation (27).

6-) Open the 6" manual control gate valve (11.2) on the pump inlet line.



*Manual control gate valve*

7-) Open the 6" manual control gate valve (11.1) on the pump outlet line.

8-) Perform discharge operation.

#### **7.4.4.3. Discharge With Pump**

- 1-) Draw near the filling station. Stop the vehicle. Engage the tractor handbrake.
- 2-) Fix the vehicle with the help of wheel chocks.
- 3-) Remove the perrot coupling cover (21).

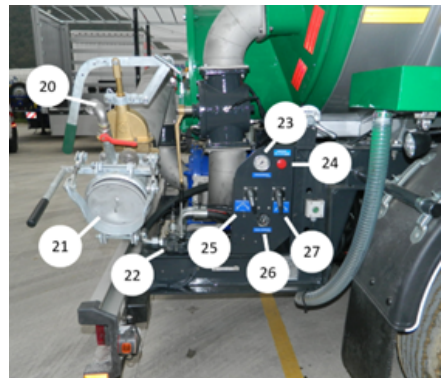

4-) Connect the perrot coupling to fill/discharge hose. Connect the other end of the hose to the coupling on the unit to be filled.

5-) Open the pneumatic on-off valve for tank ventilation (27).

6-) Close the 6" manual control gate valve (11.2) on the pump inlet line.



Manual control gate valve

7-) Set the 3-Way Ball valve (15), the discharge pump inlet line (18) to the "On" position and the tank mixing pump outlet line (19) to the "On" position.



8-) Connect the hydraulic quick couplings (31) to their counterparts on the tractor.



Hidrolik quick coupling

9-) Activate the tractor PTO and pump oil into the system.

10-) Move the hydraulic control lever (22) to the filling position manually.

11-) Perform discharge operation.

#### 7.4.4.4. Vacuum Discharge From Tank Rear Upper Funnel

1-) Draw near the filling station. Stop the vehicle. Engage the tractor handbrake.

2-) Fix the vehicle with the help of wheel chocks.

3-) Open the manhole cover on the tank.

4-) Open the pneumatic on - off valve for tank ventilation (27).

5-) Open the filling funnel 8" pneumatic control gate valve (25).

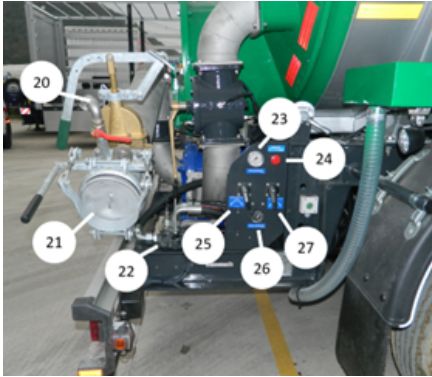

6-) Place the pumping system head from another vehicle in the filling funnel (8).

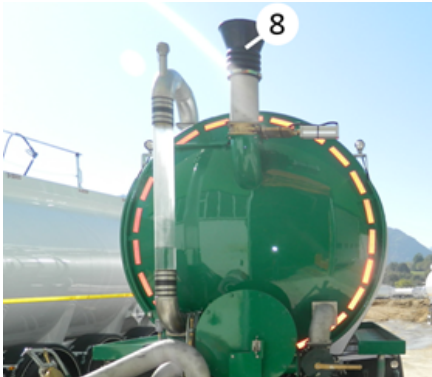

*Filling funnel*

7-) The vehicle is ready for discharge by pumping (vacuum).

8-) Perform discharge operation.

#### **7.4.5. Warnings for Filling and Discharging Operations**

- Park the vehicle to the station so that discharge connections shall be short as much as possible. Thus, the possibility of tangling or bending of the hoses is minimized.
- Stop the engine and apply the park brake when you stop the vehicle. Place chocks to the wheels if required.

- Before and during filling operation, follow the safety instructions of the transporter.
- Do not smoke !
- To prevent the risk of explosion, turn off any electrical appliances that are not used. These include the radio, cell phones and auxiliary heaters. Headlamps of the vehicle are unnecessary, too.
- Avoid conducting shoes and hard hats, wear additional protective clothes, too, if required.
- Do not carry items that may cause sparks (keys, lighters, etc.) in the pockets of the clothes. Do not wear clothes that may cause static electricity during operation.
- Do not attempt to thaw frozen man-hole covers with open flames.
- Check if all connections are in place and secure before any filling and discharging operation.

#### **7.4.6. Checks After Loading and Unloading**

Perform the following checks after loading and unloading:

- Ensure that the tanker is properly filled (filling level, load distribution, etc.).
- All valves and manhole covers are closed and secured.
- All material hoses are safely removed.
- All danger signs are in place and visible.

In addition to these controls, some of the equipment in the vehicle must also be checked in its manufacturer's manual.

## 8. INSPECTION AND MAINTENANCE

### 8.1. Safety Instructions



**There is a risk of accident that may arise in terms of a vehicle that is not built or built insufficiently. Read the following safety instructions carefully.**

- Obey all traffic laws, rules and regulations.
- Comply with all environmental regulations. When removing operation, maintenance and cleaning residues, act according to these rules.
- In addition, ensure that the equipment used in the vehicle such as axles, landing gears, pump, counter, hose reel are checked and serviced at the intervals specified in the manufacturer's user manual.



**Please refer to the pump manufacturer's manual for pump usage and warranty conditions.**



**Please refer to the compressor manufacturer's manual for compressor usage and warranty conditions.**



**If the EBS warning lamp comes on for any reason in the vehicle, immediately park the vehicle in the appropriate place and contact the nearest authorized service.**

### 8.2. Main Principles

The purpose of the maintenance operations on the vehicle is to provide the following.

- Always maintain the operating status of the semi-trailer,
- To prevent unexpected breakdowns and to extend the life of the vehicle,

- To prevent permanent damage to the semi-trailer,
- To ensure that the semi-trailer maintains its value,
- Reducing repair time for unavoidable repairs.
- The vehicle should be regularly cleaned and kept clean.

### 8.3. Checks to Be Performed Of The Time of the Delivery

- Check that the electrical system and connections and all lighting elements, brake and signal lamps are working properly.
- Check that the documents of the vehicle are in the vehicle.
- Grease the wheel plate and king pin.
- Check the tightness of the wheel nuts.
- Check that the landing gear works in both speed ranges.

### 8.4. Manhole Covers

#### Leak tightness

Small amounts of hissing air emerging while loading and unloading do not usually constitute a problem. However, none of the load should come out with the air.



*Manhole cover*

### Maintenance Operations

The fastening screws of Bracket 1 must be tightened with a torque of 50 Nm. Brackets 2, 3, and 4 have a tightening torque of 270 Nm for the matching console. The fastening is approved by national and international authorities in accordance with ADR regulations. This must be checked during every vehicle maintenance!

## Seals

The seals can only be checked when the silo vehicle is depressurized. The man-hole cover must be open.

Seals;

- Must be in visibly good condition.
- It must be clean.

Replace damaged seals as soon as possible.

Gaskets and similar consumables may wear out at different times and require replacement depending on the frequency of operation, filling-discharging intensity, cleaning procedures and usage conditions. It is therefore strongly recommended that the relevant parts be checked regularly and replaced if necessary.

## 8.5. Cataphoresis Coating

Your vehicle chassis or components may be cataphoresis coated.

Electro-coating (Cataphoresis) method is a coating method based on the accumulation of paint on the part with electric current. The most complicated parts and assemblies that require a high level of performance in terms of painting quality are covered.

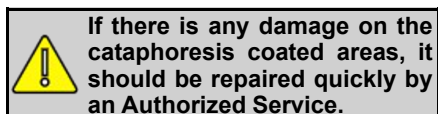

## 8.6. Galvanized Coating

Your vehicle chassis or components may be galvanized.

White mottling on the hot-dip galvanized surface of new vehicles during the winter is normal and does not affect the quality or life of the coating. Galvanized surfaces can be washed with water at a maximum temperature of 50 °C for the first 3 months.

## 8.7. Periodic Maintenance and Controls

For periodic maintenance and checks, see the warranty and maintenance manual.

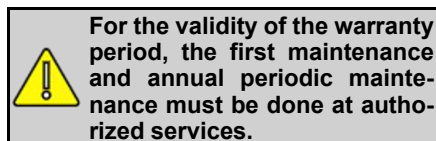

## 8.8. Important Warning!

- Check the lining thickness periodically. If the lining thickness has fallen below half, more frequent checks must be made and the lining must be changed by applying to the authorized service before the lining is finished. In the same way, the wear checks of the brake discs should be made periodically, and if there are excessive deformation and cracks on the disc surfaces, an authorized service should be immediately applied. In addition, the caliper piston and bellows should be visually checked and the operability should be checked by moving the caliper back and forth.
- For the necessary controls and periodic maintenance of the axles in your vehicle, the points in the service and maintenance instructions booklet given by the axle manufacturer with your vehicle should be applied meticulously and in accordance with the periods given in the same booklet. Failure to carry out such maintenance may affect the service life of the axles of the vehicle and may cause the axles to be out of warranty in case of a possible malfunction.

- The healthy operation of the brake system of the semi-trailer depends on the use of the semi-trailer with the same system and/or compatible tractor. For this reason, it is obligatory for the buyer to make the brake adjustment adjustment at the authorized service of the tractor company together with the tractor to which these semi-trailers / semi-trailers will be matched. In case the semi-trailer is paired and used with the tractor / tractors for which the adjustment of the semi-trailer is not made or cannot be made, the malfunctions and damages that may occur in the brake system or the tractor and the semi-trailer are outside the responsibility of our company, and all responsibility in this regard belongs to the buyer.

## 8.9. Trouble Shooting

### 8.9.1. Safety Instructions



**There is a risk of accident that may arise in terms of a vehicle that is not built or built insufficiently. Read the following safety instructions carefully.**

- Obey all traffic laws, rules and regulations.
- Comply with all environmental regulations. When removing operation, maintenance and cleaning residues, act according to these rules.
- In addition, ensure that the equipment used in the vehicle such as axles, landing gears, pump, counter, hose reel are checked and serviced at the intervals specified in the manufacturer's user manual.



**Please refer to the pump manufacturer's manual for pump usage and warranty conditions.**



**Please refer to the compressor manufacturer's manual for compressor usage and warranty conditions.**



**If the EBS warning lamp comes on for any reason in the vehicle, immediately park the vehicle in the appropriate place and contact the nearest authorized service.**

### 8.9.2. Spare Tire Replacement



**Wheel nuts that are not tightened properly will loosen. This may cause accidents. Tighten the wheel nuts to the specified torque. You can find the torque values in the manufacturer's manual for "Axles". Check the tightness of the nuts immediately after each tire change.**

#### Removing the tire:

- Park the vehicle in a safe place away from traffic.
- Secure the vehicle with wheel chocks against rolling away or tipping over.
- Apply the springloaded parking brake. (See: "Construction Components and Use of Semi-trailer" for detailed information.)



**Lock the tractor securely to prevent spontaneous or unintentional movement of the tractor during tire changing**

- Loosen the wheel nuts only one turn.

- Place the lever jack under the axle as close as possible to the tire to be replaced.
- Raise the axle until the tire to be replaced is no longer in contact with the ground. Remove the wheel nuts.

 **Take the damaged wheel off the axle, grab the wheel only by the right and left cheeks, never remove it by holding the top or bottom.**

Remove the spare tire from its holder. See spare tire holder section for detailed information.

### Fitting The Spare Tire:

- Position the spare tire as close to the wheel hub as possible.
- Lightly oil the nut threads when refitting the wheel.
- Insert a bar directly under the tire and push the wheel bolts into the holes of the rim by leveraging. Be careful not to damage the threads of the studs during this process.
- Tighten the wheel nuts as much as possible by hand tightening.
- Tighten the nuts with the wrench in the order shown in the picture.
- Lower the jack and tighten the wheel nuts in the same sequence with the required torque. Repeat this process after the first 80 km and daily for the first week.
- Check the wheel nuts for torque every week.

 Possible problems that may arise in the future can be prevented by checking all the bolt holes on the rims against ovalization at regular intervals.

Excessive tightening of the nuts of the wheel bolts will cause radial deformations around the hole, and if not tightened enough, it will cause deformations around the hole.

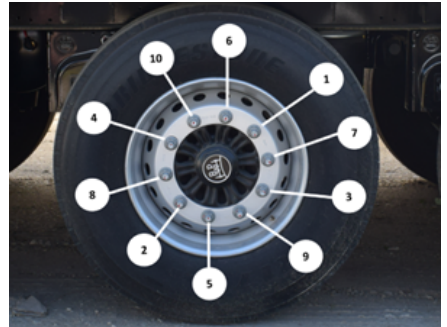

*Bolt Holes In Rimes*

 Follow all maintenance instructions, including those of the manufacturer of the vehicle parts, and always keep these instructions in your vehicle.

 The manufacturer cannot be held responsible for wear and defects caused by excessive force, or for malfunctions caused by unauthorized modifications. Irregularities or functional faults in the braking system must be rectified immediately! Only use vehicles whose brake system is functioning properly.



**Kässbohrer Sales GmbH**

**Ulm** | Im Katzenwinkel 5, 88480 Achstetten, Deutschland | T +49 (0) 7392 96797-0 | F +49 (0) 7392 96797-67

**Goch** | Siemensstraße 74, 47574 Deutschland | T +49 (0) 2823 9721-0 | F +49 (0) 2823 9721-21 | E [info@kaessbohrer.com](mailto:info@kaessbohrer.com) | [www.kaessbohrer.com](http://www.kaessbohrer.com)  
[info@kaessbohrer.com](mailto:info@kaessbohrer.com) | [spareparts@kaessbohrer.com](mailto:spareparts@kaessbohrer.com) | [aftersales@kaessbohrer.com](mailto:aftersales@kaessbohrer.com)

**Kässbohrer**

*Ingenuity, since 1893*