



USER MANUAL

# STANDARD LOW-BED SERIES



# Index

|  |    |
|--|----|
| <b>1. GENERAL INFORMATION AND SAFETY INSTRUCTIONS</b>      |    |
| 1.1. About the User Manual .....                           | 7  |
| 1.2. Meanings of Symbols Used in User Manual.....          | 7  |
| 1.3. Personal Protective Equipments.....                   | 8  |
| 1.4. Terms of Use and Safety Information .....             | 9  |
| <b>2. MAIN INFORMATIONS</b>                                |    |
| 2.1. Vehicle Identification Plate .....                    | 10 |
| 2.2. Brake Data Plate.....                                 | 10 |
| 2.3. VIN (Chassis) Numbers .....                           | 10 |
| 2.4. Warranty and Responsibility .....                     | 10 |
| <b>3. TRAILER RUNNING GEAR AND USAGE INSTRUCTIONS</b>      |    |
| 3.1. Brake System .....                                    | 12 |
| 3.1.1. Air couplings.....                                  | 12 |
| 3.1.2. Compressed Air Tanks .....                          | 15 |
| 3.1.3. EBS Socket.....                                     | 15 |
| 3.1.4. Roll Stability Support (RSS).....                   | 16 |
| 3.1.5. PREV (Park Release Emergency Valve).....            | 17 |
| 3.1.6. Brake Chambers .....                                | 18 |
| 3.2. Suspension System.....                                | 19 |
| 3.2.1. Manuel Control Lever .....                          | 19 |
| 3.2.2. Elektronik Controlled Air Suspension (ECAS).....    | 20 |
| 3.2.3. Manometer .....                                     | 20 |
| 3.2.4. Smartboard (Info Center) .....                      | 20 |
| 3.3. Electrical System.....                                | 21 |
| 3.3.1. 15 Pin Socket.....                                  | 21 |
| 3.3.2. 2x7 Pin Socket.....                                 | 22 |
| 3.3.3. Light System .....                                  | 23 |
| 3.4. King Pin .....  | 24 |
| 3.5. Landing Gear.....                                     | 24 |
| 3.5.1. Front Landing Gear's Working Principle.....         | 24 |
| 3.5.2. Rear Mechanical Foot Working Principle.....         | 26 |
| 3.6. Side Protection Equipment (Underrun Protection) ..... | 27 |
| 3.7. Semi-trailer Axle System .....                        | 27 |
| 3.7.1. Self-Steering Axles .....                           | 27 |
| 3.7.2. Axle Lifting.....                                   | 29 |
| 3.7.3. Hubodometer.....                                    | 30 |

- 3.8. Tires.....30
  - 3.8.1. Tire Pressure Monitoring System (TPMS).....31
- 3.9. Spare Wheel Holder .....32
- 3.10. Spare Tire Lowering Crane .....33
- 3.11. Wheel Chock.....34
  - 3.11.1. Pin Type Wheel Chock Holder.....34
  - 3.11.2. Pocket Type Wheel Chock Holder .....34
  - 3.11.3. Folding Wheel Chock.....35
- 3.12. Boxes and Storage Units .....35
  - 3.12.1. Steel Toolbox .....35
  - 3.12.2. Gooseneck Corner Chamfered Tool Cabinet .....36
  - 3.12.3. Fire Extinguisher Cabinet .....37
  - 3.12.4. Pillar Storage Cassette.....38
  - 3.12.5. Ramp Storage Cabinet.....38
  - 3.12.6. Wood Storage Cabinet.....39
- 3.13. Bumper.....39
- 3.14. Flooring.....39
  - 3.14.1. Wooden Floor.....40
  - 3.14.2. Grid Floor.....40
- 3.15. Loading Ramp.....40
  - 3.15.1. Hydraulic System Operated Ramps .....40
  - 3.15.2. Portable Ramps .....43
  - 3.15.3. Hydraulic Gooseneck Ramp .....44
  - 3.15.4. The Extension Bridge.....45
- 3.16. Usage Of Hydraulic Ramp .....46
  - 3.16.1. Control Of Mechanical Late-ral Sliding Ramps .....47
  - 3.16.2. Control Of Hydraulic Lateral Sliding Ramp.....48
- 3.17. Lowering The Hydraulic Ramp .....48
- 3.18. Lifting The Hydraulic Ramp.....49
- 3.19. Ramp Remote Control Function .....49
- 3.20. The Extendable Chassis .....49
  - 3.20.1. Extending And Shortening / Closing Of The Telescopic Chassis.....49
- 3.21. Wheel-Well Brigge.....52
- 3.22. Sliding Platform .....52
- 3.23. Pillar and Pillar Socket.....53
- 3.24. Extension Brackets and Woods .....54
  - 3.24.1. Side Extension Brackets.....54
  - 3.24.2. Side Extension Woods.....54
  - 3.24.3. 230 mm Sheet-Reinforced Extension Timber .....54

|           |   |    |
|-----------|---|----|
| 3.25.     | Lubrication System .....  | 54 |
| 3.26.     | Warning Signs .....   | 55 |
| 3.27.     | Rotating Warning Lamp .....   | 55 |
| <b>4.</b> | <b>COMPONENTS OF UPPERSTRUCTURE AND USAGE</b>                               |    |
| 4.1.      | Overview of Trailer Body Components .....                                   | 57 |
| 4.2.      | Front Panel .....   | 57 |
| 4.3.      | Side Panel.....   | 57 |
| 4.3.1.    | Side Panel Covers .....   | 57 |
| <b>5.</b> | <b>TRANSPORTATION PROCESS</b>   |    |
| 5.1.      | Pre-Driving Checks.....   | 58 |
| 5.2.      | Semi-Trailer and Tractor Coupling .....                                     | 58 |
| 5.3.      | Safety Instructions.....  | 59 |
| 5.4.      | Cautions During the Parking and Stopping.....                               | 60 |
| 5.5.      | Loading .....   | 60 |
| 5.6.      | Important Technical Considerations .....                                    | 60 |
| 5.6.1.    | Fire Extinguisher.....  | 60 |
| 5.6.2.    | Wheel Chocks .....  | 61 |
| 5.6.3.    | Modifications on the Trailer.....   | 61 |
| 5.6.4.    | Air Leakage.....  | 61 |
| 5.6.5.    | Considerations For the Environment .....                                    | 61 |
| 5.7.      | Cleaning the Vehicle .....  | 62 |
| <b>6.</b> | <b>TRANSPORTATION SOLUTION</b>  |    |
| 6.1.      | Container Transportation.....   | 63 |
| 6.1.1.    | The Container Locks .....   | 63 |
| 6.2.      | Heavy Machinery Transport.....  | 63 |
| <b>7.</b> | <b>LOADING AND LOAD SECURITY</b>  |    |
| 7.1.      | Safety Instructions.....  | 64 |
| 7.1.1.    | Load Security .....   | 64 |
| 7.2.      | Load Distribution and Load Limits of Truck-Semi-Trailer<br>Combination..... | 65 |
| 7.2.1.    | Downlink Load Lashing.....  | 65 |
| 7.3.      | Lashing Rings.....  | 67 |
| 7.4.      | Loading Tables .....  | 67 |
| 7.4.1.    | The Loading Table With Container Lock.....                                  | 67 |
| 7.4.2.    | The Load Carrying Tables.....   | 67 |
| 7.5.      | Loading Crane.....  | 68 |
| 7.6.      | Pallet or Platform Transport Instructions .....                             | 68 |

|         |   |    |
|---------|---|----|
| 7.7.    | Lowbed Vehicles Loading Instructions.....       | 68 |
| 7.7.1.  | Pre-installation Preparations .....             | 68 |
| 7.7.2.  | Position of Load .....                          | 69 |
| 7.7.3.  | Center of Gravity of the Load .....             | 69 |
| 7.7.4.  | Loading Diagram .....                           | 69 |
| 7.7.5.  | Loading Surface of The Load .....               | 70 |
| 7.7.6.  | Spread Load Transport.....                      | 70 |
| 7.7.7.  | Loading With Two Support.....                   | 70 |
| 7.7.8.  | Loading With Four Support .....                 | 71 |
| 7.7.9.  | Loading at Vehicle That Has Ramp .....          | 71 |
| 7.7.10. | Extending Type Expansion Bracket Overload ..... | 71 |

## **8. INSPECTION AND MAINTENANCE**

|         |  |    |
|---------|--|----|
| 8.1.    | General Information .....  | 73 |
| 8.2.    | Disposal of Used Materials .....   | 73 |
| 8.3.    | Conditions of the Place where Service and Maintenance<br>Operations are Made ..... | 73 |
| 8.4.    | Periodic Maintenance and Controls .....  | 73 |
| 8.5.    | General Maintenance Program.....   | 73 |
| 8.6.    | Hydraulic and Pneumatic Hoses and Connections.....                                 | 75 |
| 8.7.    | Tightening Torques for ISO Standard Bolts.....                                     | 75 |
| 8.8.    | King Pin .....   | 75 |
| 8.8.1.  | King Pin Assembly Bolt.....  | 75 |
| 8.8.2.  | Changement of King Pin.....  | 75 |
| 8.8.3.  | King Pin Maintenance.....  | 76 |
| 8.9.    | King Pin Steering Center Bearing Control.....                                      | 77 |
| 8.10.   | Maintenance of Extendable Lowbed Platform.....                                     | 77 |
| 8.10.1. | Tightening Torques of Wheel Nuts .....   | 77 |
| 8.10.2. | Nut Tightening Sequence .....  | 78 |
| 8.10.3. | Tire Inflation Pressure .....  | 78 |
| 8.10.4. | Alloy Rim Wheels.....  | 78 |
| 8.11.   | Hidrolic Oils.....   | 78 |
| 8.11.1. | Mixing Hydraulic Oils .....  | 79 |

## FOREWORD

First of all, thank you for choosing us for your new vehicle investment.

Your vehicle is manufactured with the latest production technologies to the highest quality standards and equipped with the best safety and efficiency features.

You can find detailed information about the accessories, equipment and hardware that might be in your vehicle in this manual. The defined options in this manual can vary according to the vehicle specs.

Important information on how you can use your vehicle is explained in this user manual, please be sure that you review and understand the content. We suggest keeping this user manual available in your vehicle at all times. This information is specified in the product's user manual. We recommend you read this operating manual thoroughly to get the most out of your vehicle.

*\* Owing to the developments in product research, the manufacturer reserves the right to make any changes in the product, without any prior notice. The publication rights of this documentation belong to the manufacturer.*

# 1. GENERAL INFORMATION AND SAFETY INSTRUCTIONS

## 1.1. About the User Manual

The usage and operation information given in this manual is prepared to make sure the vehicle is used in compliance with its purpose and as desired.

The instructions here contain important recommendations to perform your operations safely, completely, and in the most efficient manner. Complying with these instructions, warnings and recommendations will prevent accidents, decrease down-time & repair costs, and make sure you use your vehicle safely, reliably and problem-free.

Please read the operating instructions in this manual carefully and completely. The manufacturer is not liable for the damages and deficiencies caused by the failure to comply with these instructions. The instructions herein must be supported by local laws, rules and regulations. Please comply with these instructions to prevent accidents and protect your surroundings and the environment.

Any usage of transportation that goes beyond the use in accordance with the rules will be considered improper use.

Transportation of the following is not allowed:

- Carrying people and live animals
- Transportations that need to be carried according to special instructions, e.g., dangerous good transportations
- Transportation of unsecured goods
- Transportation of materials that are dangerous due to their properties or that need to be carried with special equipment
- Exceeding technically and legally permissible weights of the axles or king pin load

- Exceeding of the maximum vehicle speed
- Exceeding the permissible length, width and height
- Unapproved parts like tires, accessories, spare parts and etc. by the manufacturer
- The manufacturer shall not accept any responsibility for the problems and faults that occurs that are not in compliance with the purpose of the vehicle's usage. All the risks of this issue belong to the customer.

 **It is necessary to keep the user manual available on the vehicle at all times.**

 **The vehicle can be equipped with a lot of different options. The standard or optional features will be explained in the manual. Some options may not be available for your vehicle**

 **Adhere strictly to the operating instructions when using your vehicle. When problems occur which can lead to dangerous consequences, contact the service centre immediately.**

## 1.2. Meanings of Symbols Used in User Manual

Several warnings are available in this manual to ensure maximum safety when using your vehicle. Each warning is indicated by a special symbol. These symbols and their meanings are as follows.



The information specified by this warning symbol is very important for health and human safety. When the given information is ignored, serious damage, injuries and even death may occur.



This symbol specified in this manual indicates that critical accidents may occur when the instructions do not comply.



This symbol is used when additional information is required.



This symbol is used when chemicals and other substances can be disposed of with precautions that will not harm the environment.

### 1.3. Personal Protective Equipments

Personal protective equipments serves the purpose of preventing injuries and are prevents injuries and are determined by regional regulations depending on the load carried.

People who will work or perform operations on the vehicle must wear proper and appropriate protective clothing.

- Depending on the load to be carried, the eyes, ears, body, and respiratory tract must be protected with the relevant protective equipment.
- As a rule, gloves and work shoes are always used.



It is obligatory to use appropriate personal protective equipment during the operations.



Long hair is particularly dangerous when working on the vehicle, regardless of whether it is loose or tied up, and it should be protected properly to avoid tangling.



Wearing a tie, necklace and/or dangling jewelry when working on the vehicle is strictly prohibited. They may get caught in moving parts or mechanisms and cause injuries and even death.

### Protective Gloves



During the operation, protective gloves must be used. Please make sure you are using the correct type of gloves when you are working with hot parts or chemicals.



Gloves should fit snugly. Otherwise, there is a risk of them getting caught in moving parts or mechanisms.

### Protective Cloth



While working on the vehicle, appropriate overalls must be worn.

- Overalls should not have pleats, buttons or external pockets and their closure system should be made in such a way that they can be opened as soon as possible in case of an emergency.
- Interior pockets should have fastenings to close them up. Cuffs should be adjusted to fit the wrist.

### Protective Helmets



**When working around the vehicle, a lightweight helmet approved by an accredited institution should be worn.**

### **Protective Ear Plugs**



**A hearing protective device (headsets or ear plugs) should always be used around self-propelled vehicles.**

### **Protective Goggles**



**Protective goggles should be worn during all maintenance operations.**

### **Protective Mask**



**Appropriate protective masks should be used when working with substances that are dangerous to breathe or in dusty environments.**

## **1.4. Terms of Use and Safety Information**

It is necessary to keep the warranty, operating and maintenance manual and other documentation about the vehicle available on the vehicle at all times.

To prevent possible accidents and environmental pollution, follow the operating instructions and binding regulations.

- Pay attention to the safety and warning signs placed on your vehicle.
- Always keep these safety and warning signs completely visible.
- Make sure that the load carrier is secured properly.
- In case of any dangerous condition in the operation of safety, stop your vehicle immediately and inform the authorized people or institutions.
- Do not modify anything on the vehicle without a written manufacturer's approval. Your vehicles guarantee terms do not cover unapproved modifications.
- The spare parts must meet the technical requirements set forth by the manufacturer company. Only the original spare part/parts meet their requirements.

## 2. MAIN INFORMATIONS

There are vehicle identification stickers on the vehicle.

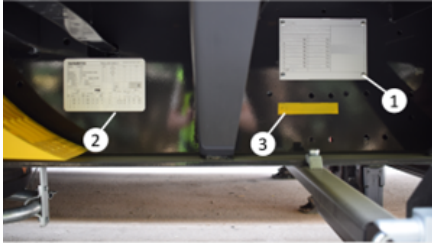

### 2.1. Vehicle Identification Plate

Vehicle identification plate (1) is located on the right side of the vehicle.

You may find the following information's on this plate;

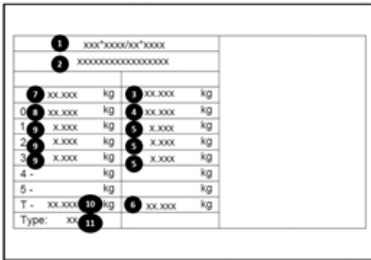

Vehicle Identification Plate

- 1- Type approval number
- 2- VIN number
- 3- Technical total capacity
- 4- Technical king pin capacity
- 5- Technical an axle capacity
- 6- Technical total axle capacity
- 7- Nationally approved total capacity
- 8- Nationally approved king pin capacity
- 9- Nationally approved an axle capacity
- 10- Nationally approved total axle capacity
- 11- Vehicle Type

### 2.2. Brake Data Plate

There is a brake data plate on the vehicle which is equipped with an EBS system.

You may see this information on this plate.

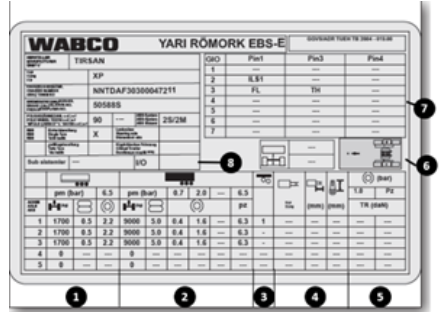

Vehicle Identification Plate

|   |                                   |
|---|-----------------------------------|
| 1 | Empty vehicle(without load)       |
| 2 | Loaded vehicle                    |
| 3 | Axle lifting                      |
| 4 | Brake chamber data's              |
| 5 | References                        |
| 6 | ABS Sensor Placement              |
| 7 | Extra functions, Pin / GIO Matrix |
| 8 | IN/OUT-Connections                |

### 2.3. VIN (Chassis) Numbers

The VIN (chassis) number (3) is located on the right side of the vehicle and marked with a different color than the chassis color.

### 2.4. Warranty and Responsibility

Our trailers, semi-trailers and truck on-board applications are manufactured in

compliance with regulations and our quality standards. It is necessary to perform the maintenance to ensure our products always operate in the most efficient manner in compliance with our latest directives and maintenance programs. The warranty starting date is the date that the vehicle is delivered to the customer.

The performance of maintenance and repair/servicing of the vehicle with the use of original spare parts by authorized service shall assure the client's warranty rights. This warranty is based upon the usage and maintenance conditions described herein and in the warranty book. Thus, it is important to read and understand this operation manual and warranty book.

It is necessary to keep the warranty, always operating and maintenance manual available on the vehicle to allow authorized service performing the servicing to see the warranty conditions and maintenance records. In the repairs made during the warranty period, the authorized service performing the repair will demand this. Purchasing one trailer or semi-trailer is an important investment. For the highest return on your investment, it is necessary to comply with the manufacturer's procedures and recommendations during the operation period of the vehicle. The information provided by the client/driver related to the warranty written in this manual shall be kept within our database.

### 3. TRAILER RUNNING GEAR AND USAGE INSTRUCTIONS

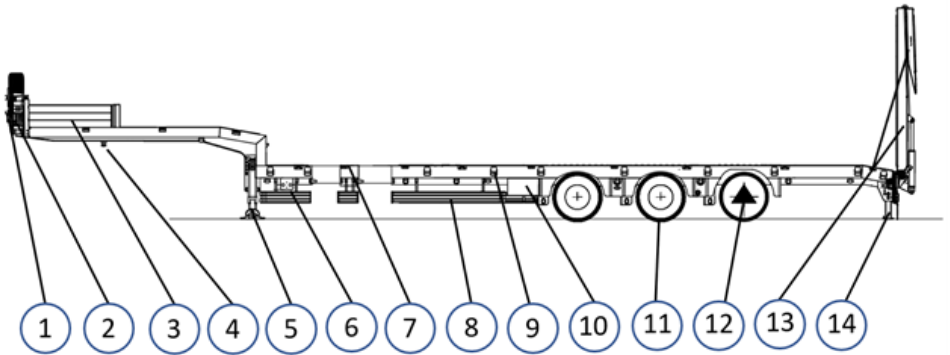

- 1.Spare Wheel Holder
- 2.Extinguisher cabinet
- 3.Gooseneck panels
- 4.King Pin
- 5.Landing legs
- 6.Brake control panel
- 7.Sliding platform
- 8.Side protector
- 9.Extension bracket
- 10.Command cabinet
- 11.Tire
- 12.Self-steering axle
- 13.Ramp
- 14.Rear support legs

types of air couplings have the same function but with different shapes and connections. There are 2 different air supply lines in the system.

- Brake Line (Yellow)
- Supply Line (Red)

**Service Line:** It is the pneumatic line where the pneumatic brake signal from the truck is transmitted.

**Supply Line:** It is the pneumatic line where the compressed air needed by the trailer is transmitted from the truck.

According to the type of vehicle, your vehicle can be equipped with one or two different types of air couplings.

- Standard Couplings (Palm)
- Duomatic Coupling
- C (UK) Couplings

#### 3.1. Brake System

##### 3.1.1. Air couplings

The main connection between the truck and trailers is air couplings.

Generally, 3 different types of air couplings are used in the trailers. These 3



If your vehicle is equipped with 2 different types of couplings, you must use only one type at the same time.



When the couplings are mounting/demounting, the parking brake of the truck and trailer must be engaged.



If the brake parameters are modified, your vehicle's brake calculation might be non-suitable for regulations. Only authorized services must service to the EBS modulator.



Only authorized services and personnel should make service operations for the brake system.

There might be test points on the chassis or above the air couplings. When you remove the test points rubber protection parts and push the points you can check the air pressure on the brake lines.



One of the test points is the service line. As long as there is no brake signal from the truck side, this line will be empty, there will be no air at the test point. The other test point is the brake air tubes line. From this test point, it can be checked whether there is air in the vehicle.



The location of the control cabinet on the lowbed vehicle



Test point



Palm coupling with a test point

### 3.1.1.1. Mounting of Standard (Palm) Couplings

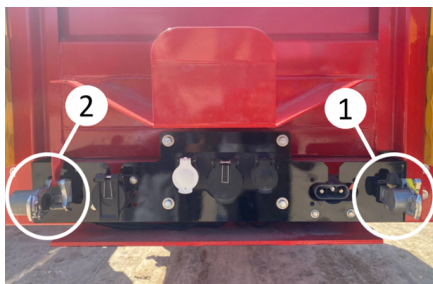

Couplings

- Slightly slide plastic covers to the upper side. Slide plastic covers to upper side.
- Be sure that sealing surfaces are clean and durable. If necessary, clean/change the air coupling.
- The coupling which comes from the truck should be pushed slightly from the upper side to the lower side and

connect the coupling. Be sure that couplings are matched correctly.

- First mount service line yellow (1).
- Mount supply line red (2).

### 3.1.1.2. Demounting of Standart (Palm) Couplings

- The coupling which comes from the truck should be pushed slightly from the lower side to the upper side and demount the coupling.
- First demount the supply line red (2).
- Demount the service line yellow (1).
- Slightly slide plastic covers to the lower side and close the plastic covers.

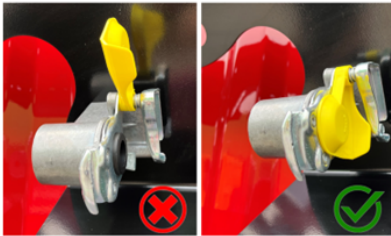

*Closing the coupling*

 **Driving with a non-suitable air connection is dangerous and forbidden.**

 **Using damaged air supply parts can cause serious hazards. Torn or damaged compressed air connectors reduce the vehicle's braking performance.**

### 3.1.1.3. Mounting of C (UK) Couplings

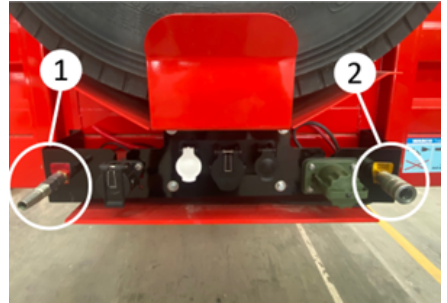

*C (UK) couplings*

- Be sure that sealing surfaces are clean and durable. If necessary, clean/change the air coupling.
- First mount service line yellow (1).
- Mount supply line red (2).
- Be sure that couplings are matched correctly.

### 3.1.1.4. Demounting of C (UK) Couplings

- Push the latch from front to back side on the C couplings and remove.
- First demount the supply line red (2).
- Demount the service line yellow (1).



The coupling filters have to be clean regularly.

### 3.1.2. Compressed Air Tanks

Pressured air can be stored in the air tanks.

The quantities and capacities of the air tanks can be changed according to your vehicle specifications.

In cold periods of the year or when the air humidity is high, the moisture in the air can be condensed and collected in the compressed air tank.

The trucks are generally fitted with air driers to prevent condensation in compressed air. The trucks are generally fitted with air driers to prevent condensation in compressed air. Even if the air driers system, the humidity in the air can be condensed. The condensed water must be drained out via the drain valve.

The water in the air tanks should be completely drained out. That's why please push the valve on the air tanks.



*Air Tank*

1. 1.Compressed Air Tanks
2. 2.Drain valve



The water in the compressed air tank can cause corrosion problems and affect the functionality of the brake system. The frozen water in the pneumatic lines can cause the failure of the brake system.



The water in the pneumatic system should be checked more frequently in cold weather or extremely variable outside temperatures.



When the air tank pressure is lower than 4,5 bars, the EBS warning lamp on the truck turns on and the driver can see this situation.



When the pressure in the service line (in the yellow coupling) is lower than 2,5 bars, the brakes automatically lock.

### 3.1.3. EBS Socket



*EBS Socket*

Our trailers and semi-trailers are equipped with an EBS system.

EBS is an electronically controlled brake system, that is fitted with automatic load sensing braking pressure regulation (ALB) and automatic anti-skid systems (ABS/ABV).

To activate the EBS system, your truck and trailer must be equipped with an EBS system. Please mount the EBS cable that will come from the truck to the EBS socket on the trailer.

- Driving with a non-connected EBS connection is illegal.
- Drive only with an approved and well-operating EBS plug connection in accordance with regulations.
- EBS connection must be made between the truck and trailer.
- Verify the EBS plug connection with a system check (the solenoid valves in the EBS modulator are activated and briefly activated and deactivated for 2 seconds after "ignition on").

When the truck engine is activated and during the travel, the EBS system will be checked automatically. If the truck screen is suitable/adjusted, the EBS failures will be shown with the EBS mistake lamp.

The EBS mistake lamp on the truck screen will be turned on when the ignition key is activated. If there is no failure on the EBS system, the lamp will be turned off in appr. 2 seconds.

After 7 km/hours speed, If there is a failure on the EBS system (Sensor mistake and etc.) EBS lamps will be flashed.

If the EBS lamp is activated, please contact with authorized services immediately.

**The trailers equipped with a Trailer EBS E braking system may only be used with tractors with:**

- ISO 7638-1996 connectors (ABS + CAN) or ISO 7638, 7 pin with CAN data line (EBS Truck)

 Even if the truck 7 pin socket (ISO 7638) has a CAN data line, if the spiral cable used between the truck and the trailer is 5-core, it will cause the trailer EBS Modulator to not work properly. For this reason, a 7 core spiral EBS patch cable should always be used.

 If you drive without EBS connectors or if there is a problem on the EBS system, the brake system will not be worked properly. This situation may cause an accident.

 Trailers are equipped with an additional power supply for the EBS system. Thanks to the extra power supply from brake lamps, when the EBS connector is damaged, an extra safety function will be activated. The EBS system will be fed from brake lamps and ALB (automatic load sensing braking pressure) and ABV (anti-skid system) functions will be activated.

### 3.1.4. Roll Stability Support (RSS)

Rollover stability support (RSS) is integrated into the trailer modulator. The vehicle's electronic control unit analyzes wheel speed, load information and transverse acceleration data to detect the likelihood of vehicle roll-over before the driver realizes there is a risk and automatically applies the brakes. But don't forget that this system cannot cancel the laws of physics.

When the roll-over risk is detected, the EBS system makes automatically brakes and tries the reduce the roll-over risk. After risk, the RSS function will be shut down automatically.



The RSS optimizes driving characteristics and in emergencies may help to prevent accidents. But cannot completely guarantee.



This function can only be used on 3-axle non-extensible vehicles!

### 3.1.5. PREV (Park Release Emergency Valve)

Generally, brake control systems will be located on the driver's side. It may be different on your vehicle according to the vehicle's construction.



*PREV Buttons*

**Black button (1):**Service brake button.

**Red button (2):**Park brake button



When you are driving the trailers, the red button must be pushed position and the black button has to be pulled position.

#### 3.1.5.1. Service Brake

Thanks to the service brake, the trailer can be made maneuvers without air connections. The black button can be used only without semi-trailer air supply (red) connections on the trailer.

When you push the black button, the service brake will be disabled. When you pull the black button, the service brake will be activated.



If the service brake is used a lot of times, without an air connection, air pressure in the system and braking power may reduce.

When the air connections are de-mounted, the service brake will be automatically activated. When the air connections are mounted, the service brake will be automatically disabled.



The service brake is not suitable for brak-ing of the semi-trailer permanently. During longer waiting periods, the semi-trailer must be secured with a spring-loaded park brake and with wheel chocks.

#### 3.1.5.2. Park Brake



*Spring loaded park brake*

Spring loaded park brake control button is used for longer parks of semi-trailers with or without truck on plain or inclined lands.

It is a spring force based brake. It does not need air for braking. When the air tube pressures of the trailer fall below 2.5 Bar, it is automatically activated and the brake is activated with the spring force.

When the red button is pulled, spring loaded park brake will be activated. When the operator push the red button, spring loaded park brake is deactivated.

If the trailer air tubes are empty, the brake cannot be disabled even if the button is pressed.



**This brake will not be deactivated automatically. Before driving, the operator must deactivate the brake.**

### 3.1.6. Brake Chambers

Your vehicle may be equipped with disc or drum brake axles according to your choice. For both brake types, the brake chambers are going to use for braking. The brake chambers will be chosen according to axles type and loading capacity. The maintenance, modification or repair operations must be performed by authorized services.

#### 3.1.6.1. Manually Deactivation of Parking Brake Spring

The Parking brake spring may be deactivated manually in emergency situations.

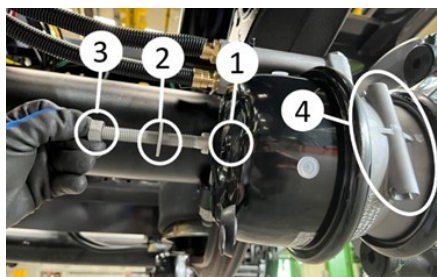

*Deactivation of brake chambers*

1. Boreholes

2. Release rod

3. Nut

4. Slot of the release rod

- Remove the release rod (2) from the slot (4).
- Insert the release rod (2) to boreholes (1) and screw till the rod (2) will be fitted completely.
- Completely screw in the nut (3) to the release rod (2).

The brake chambers will be deactivated after this operation. In this case, the brake chamber only works on the service

brakes. Even if the trailer air tube pressure drops below 2.5 Bar, the spring brake will not be activated due to this operation.



**On some brake chambers used in vehicles, the emergency release screw is located in its socket (1) behind the brake chamber, not in its socket (4) next to it. In order to disable the springs, it is allowed to come out by simply turning it with the appropriate key.**



**This operation should only be used until the trailer is serviced.**



**Before this operation, the vehicle must fixed securely with wheel chocks. Serious injuries may occur.**

#### 3.1.6.2. Activation of Brake Chambers

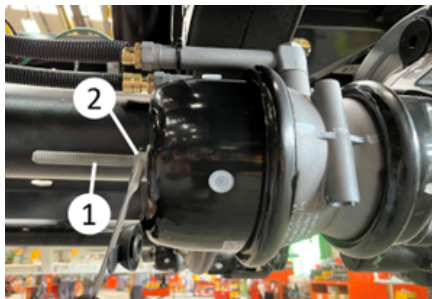

*Activation of brake chambers*

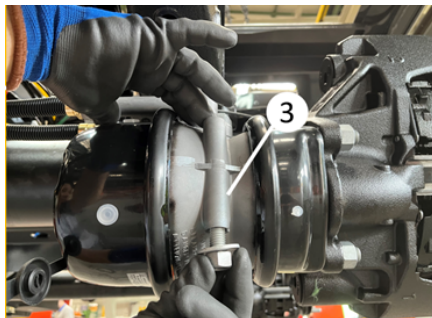

- Remove the nut (1) from release rod (2) with a spanner.

- Remove the release rod (2).
- Screw the release rod into its place on the brake chambers (3)
- Close the plastic cover on the brake chamber.

Brake chamber will be activated after this operation.

 **Before this operation, the vehicle must be fixed securely with wheel chocks. Serious injuries may occur.**

 **Don't drive without being sure that all the brake system is working properly after this operation**

### 3.2. Suspension System

Your vehicle is equipped with air suspension system.

 **When entering uneven or damaged roads, the fifth-wheel plate height and the trailer should be raised. Otherwise, the front part of the trailer may come into contact with the tractor, or trailer components may be damaged. While raising the vehicle, check the external height and make sure it does not hit anything. Comply with legal height limits. Once the problematic area has been passed, the vehicle should be returned to driving height.**

#### 3.2.1. Manuel Control Lever

##### Operation:

The lowering / lifting valve (1) on the command panel can lower or raise the rear of the stationary semi-trailer for various purposes, such as carrying out loading operation.



*The location of command cabinet*

The middle position of the lever (1) allows the semi-trailer to reach the driving level regardless of the load.

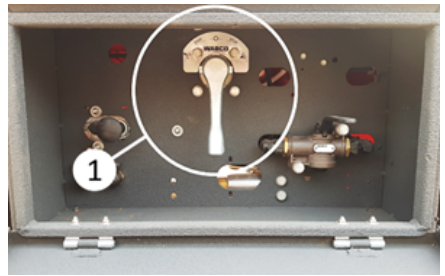

*Manually operated air suspension driving position*

You can lift the trailer up by turning the control handle counterclockwise.



*Raising of suspension*

You can lower the trailer down by turning it clockwise.



Lowering suspension

To fix the suspension height, you may turn the lever 45° or 135° according to the photo in below. Before driving, the lever must be switched to driving position.



**If the trailer will be driven at a non-driving height, the vehicle may be damaged, or a height problem may occur.**

### 3.2.2. Electronic Controlled Air Suspension (ECAS)

Electronic controller air suspension (ECAS) is an optional solution. This system sets the driving height or defined different heights electronically. When the EBS socket is mounted and driving at a speed defined by the producer, the lever will set the driving height automatically.



ECAS control panel

### 3.2.3. Manometer

It shows the load falling on an axle in tons according to the pressure in the air bags.

When the air bag pressure is bigger, you will see bigger values on the manometers.



Manometer



**This manometer shows only the estimated axle load. It cannot be used as a legal measurement.**

### 3.2.4. Smartboard (Info Center)

Thanks to Smartboard, the operator may see failure codes, axle load etc. information and control the axle lifting system.



Smartboard

The functions provided by the Smartboard are as follows:

- It can be used as a control panel in vehicles with ECAS (including double level).
- AKS load indicator
- Diagnostic memory
- Lift axle control for vehicles with automatic axle lift

If your Smartboard includes the battery, you may use some control even if the truck is not connected.

**You may check Smartboard user Manual for the detail information.**

### 3.3. Electrical System

15-pin socket (ISO 12098) + 2x7-pin socket (ISO 1185 (24N) / ISO 3731 (24S)) are used to supply the lighting system in our vehicles. With the help of a 15-pin socket or a 2x7-pin socket, you can supply electricity from the truck to your vehicle.



Electrical system

**When driving, the electrical sockets between the truck and trailer must be connected.**

**Please be sure that the truck and trailer are suitable for the norms/standard about electrical systems. Otherwise, electrical problems will occur.**

#### 3.3.1. 15 Pin Socket

This system provides electricity for the electrical system on the vehicle like stop

lamps, signal lamps etc. 15 pin socket connections are made according to ISO 12098.

Open the protection cover and mount the sockets regularly.

You may find extra information about the pins function in below.

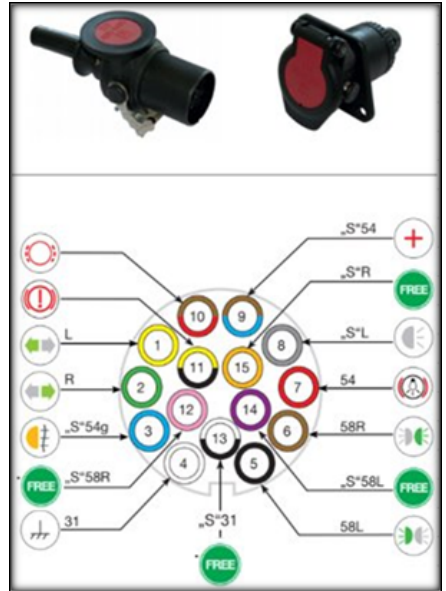

ISO12098 Socket

| Pin | Explanation     |
|-----|-----------------|
| 1   | Left indicator  |
| 2   | Right indicator |
| 3   | Fog lamp        |
| 4   | Ground          |
| 5   | Left taillight  |
| 6   | Right taillight |
| 7   | Brake light     |

|    |               |
|----|---------------|
| 8  | Reverse light |
| 9  | Supply line   |
| 10 | Empty         |
| 11 | EBS           |
| 12 | Empty         |
| 13 | Empty         |
| 14 | Empty         |
| 15 | Empty         |

| Pin | Explanation   |
|-----|---------------|
| 1   | Ground        |
| 2   | Empty         |
| 3   | Reverse light |
| 4   | Supply line   |
| 5   | Empty         |
| 6   | Empty         |
| 7   | Fog lamp      |

### 3.3.2. 2x7 Pin Socket

This system provides electricity for the electrical system on the vehicle like stop lamps, signal lamps etc. 2x7 pin socket pin connections are made suitable for 24S ISO 3731 and 24N ISO 1185 norm.

Open the protection cover and mount the sockets regularly.

You may find extra information about the pins function in below.

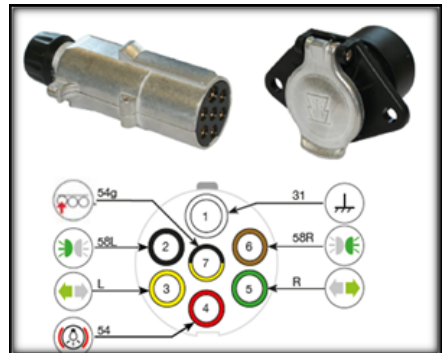

ISO 1185 Socket

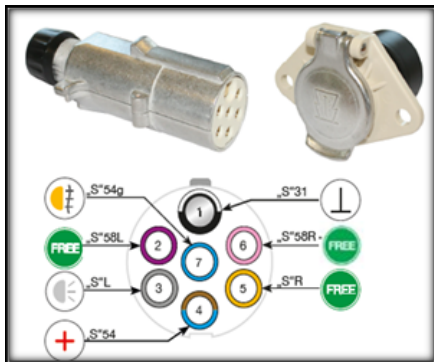

ISO3731 Socket

| Pin | Explanation     |
|-----|-----------------|
| 1   | Ground          |
| 2   | Left taillight  |
| 3   | Left indicator  |
| 4   | Brake light     |
| 5   | Right indicator |

|   |                 |
|---|-----------------|
| 6 | Right taillight |
| 7 | Axle lifting    |

**Please be careful with the color of the sockets. The black socket is suitable for ISO 1185 and the white socket is suitable for ISO 3731. If the vehicles are suitable for norms, the black socket on the truck will be connected to the black socket on the trailer and the white socket on the truck will be connected to the white socket on the trailer**



### 3.3.3. Light System

The vehicle is equipped with a light system which is suitable for the regulations.

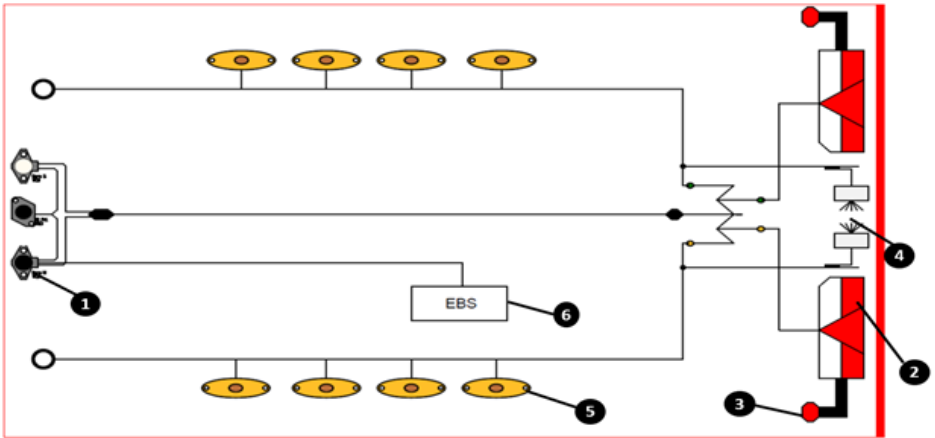

|   |                     |
|---|---------------------|
| 1 | Electrical Sockets  |
| 2 | Stop Lamps          |
| 3 | End Outline Markers |
| 4 | License Plate Lamps |
| 5 | Side Position Lamp  |
| 6 | Modulator           |



**When needed, you can obtain the electrical diagram of your vehicle from the manufacturer.**

The lamps must be checked regularly. If there is any problem with the electrical system, it must be repaired immediately. In a repair operations, only original and approved sockets or parts must be used.



**If you add or remove any lamps on the vehicle, your vehicle may be non-suitable for regulations.**



**Vehicles with LED electrical systems consume very low energy. For this reason, although there is no problem in the system, it may cause the failure lamp to come on in old tractors.**



**Repairing operations of the electrical system have to be made by only authorized services. Otherwise, electrical problems may occur or your vehicle may be out of warranty.**

### 3.4. King Pin

King pin is a shaft which connects truck and trailer together. Your vehicle may be equipped with 2" or 3.5" diameter pins. Please check the king pin diameter before connecting the truck.



**If you match the truck and trailer with a different diameter king pin, injuries may occur.**

The flanged king pin is used on the vehicle. That's why king pin can be replaced easily.



*King Pin*



**If the wearing on the king pin is bigger than 2 mm, the king pin must be replaced.**

Your vehicle may be equipped with a double king pin slot. You can remove the bolts around the king pin and mount king pin to the other slot. Please be careful about the total length of the vehicle according to country regulations and be sure that the total length is suitable for regulations.



*Double king pin*

### 3.5. Landing Gear

There is a front landing gears behind the vehicle's gooseneck area so that your vehicle can stop in park without truck.

#### 3.5.1. Front Landing Gear's Working Principle

The landing gear crank handle (1) should be removed from its holder (2) and brought to a perpendicular position to the vehicle.



Landing Gear

**Low Speed (A):** When the crank handle (1) is turned in the fully pressed position, it raises / lowers at low speed.

**High Speed (B):** It performs high speed lifting / lowering when the lever turned in the fully extended position. The position is used to quickly lower the gear until the foot (plates) touch the ground during the process of separating the semi-trailer from the tractor, or to raise the gear quickly after the semi-trailer is connected to the tractor.



The landing gear crank handle is usually located on the passenger side of the vehicle.

 In all conditions, secure the semi-trailer against tipping with correctly positioned wheel wedges. If the vehicle is not properly secured, the landing gear or the vehicle may be damaged.

 If the loading / unloading operation is performed while semi-trailer is not paired with the tractor, the front or rear of the vehicle may raise. Serious accident and damaged may occur. For this reason, the semi-trailer must be paired with the tractor during the loading and unloading operations.

 If the tractor leaves from the loaded trailer, be sure that the load is distributed homogeneously in the vehicle. Otherwise, the front or rear section of the vehicle may be raised due to centre of gravity, and accident may occur.

In order to protect the landing gear, be sure that there won't be any lateral movements on your vehicle. For this reason give attention to the following criteria:

- Disconnect the semi-trailer from the tractor only when the landing gear are in the middle (neutral) position.
- If you will park for a long time without the coupled tractor, be sure that air suspensions are lowered and after that adjust the landing gears. Thus, the loading area will be parallel to the ground.



Landing gear view

Optionally, an aluminum landing gear can be supplied.

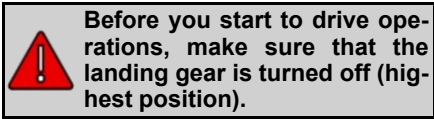

### 3.5.2. Rear Mechanical Foot Working Principle

Rear supports are used to support the ramps while loading and unloading the trailer.

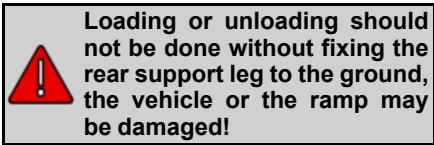
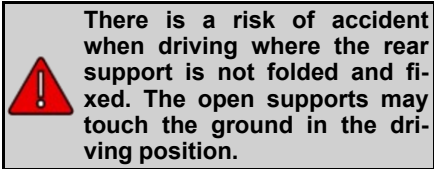
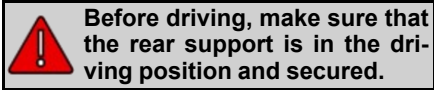

#### 3.5.2.1. Lowering the rear support

- The rear support is in the folded position while driving. Open the pin lock latch (2) to remove the pin (1) that fixes it in this position.
- Take the pin out of the hole by holding the handle at the end of the rear support.

- Release the rear support (3) until it is in the upright position.
- Insert the removed pin (4) into the other hole while in this position.
- Insert the cotter pin on the back and fix it with the pin holder.
- Lower the vehicle with the suspension system to place the rear support on the ground. See. *Suspension system*.

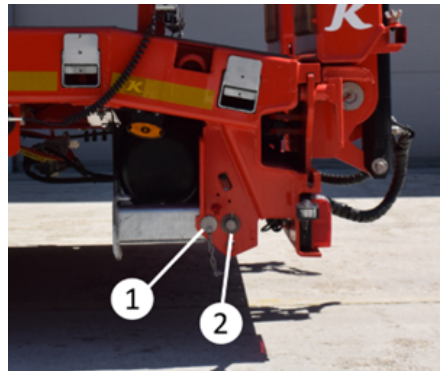

Fixing pin and latch

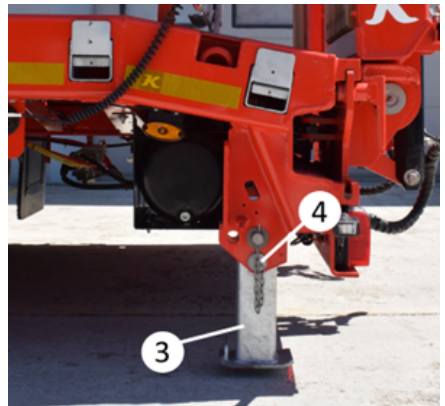

Rear support leg and pin

#### 3.5.2.2. Hydraulic Rear Support Leg

It is given optionally according to the customer's request.

The hydraulic rear support leg (1) is used for the same purpose as the rear

mechanical leg. Its length can be adjusted with the hydraulic control panel (2).

It is used as described on the usage label on the vehicle.

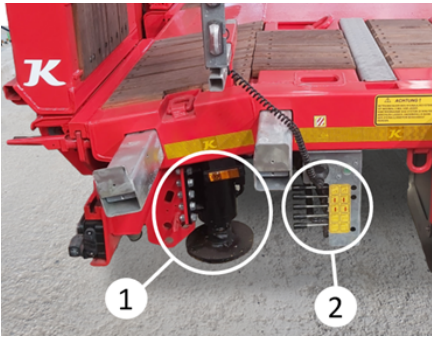

Hydraulic rear support leg and lever valve block

- 1:Hydraulic support leg
- 2:Lever valve block

### 3.6. Side Protection Equipment (Underrun Protection)

Standard Lowbed vehicle has fixed side protection equipment.



Side protectors

### 3.7. Semi-trailer Axle System

Axle with disc or drum type brake mechanism are used in your vehicles.

Semi-trailer axles may only be loaded with the maximum legally permissible axle load indicated on the vehicle identification plate. The user is responsible for use of the trailer in accordance with its purpose and capacity and for its maintenance.

The healthy operation the brake system of the semi-trailer depends on the use of the semi-trailer with the same system and/or compatible tractor. For this reason, its obligatory for the buyer to market he brake adjustment at the authorized service of the tractor company with which these semi-trailer / trailers will be matched. In case your vehicle is paired and used with tow tractors that are not or cannot be adjusted, malfunctions and damages that may occur in the brake system or in the entire tractor and semi-trailer are outside the responsibility in this regard belongs to the buyer.

 **For more detailed information about your axles, please refer to manufacturer's manual given to you at the time of delivery.**

 **If the axles are used other than the conditions specified in the manufacturer's manual or if their maintenance is interrupted, your vehicle may be out of warranty.**

 **If the vehicle is equipped with the emergency brake bellows, apply the parking brake after checking the brake drum temperatures. Never apply the parking brake when the drums are very hot.**

#### 3.7.1. Self-Steering Axles

Your vehicle has a steerable axle to increase its maneuverability during the forward driving. This type of axle is usually rear axle of the vehicle and has a locking mechanism.



The mobility of the self-steering axle vehicle is different from standard vehicles. In addition, there will be differences in the maneuverability of the vehicle in cases when the steering axle is lock and unlocked. Therefore, you should be careful while driving.

### 3.7.1.1. Locking The Steering Axles



Location of valve

The location of the vagrant axle locking valve.

For reversing vehicles with Electronic Brake System (EBS), the stray axle can be locked automatically when the reverse gear is engaged. It is also possible to lock this axle manually.

Drive the vehicle straight ahead so that the stray axle is in a level position before the stray axle locks up. Engage reverse gear and the stray axle will be locked automatically.

If you want to lock the axle manually, make sure that the stray axle is in a straight position and close the valve (1).

The axle is in the locked position when the valve handle is turned towards you.



If the stray axle is active in your vehicle, the stray axle will be locked automatically when the reverse gear is engaged.



Reversing with the steered axle unlocked is dangerous. The semi-trailer can be separated from the tractor. Make sure the stray axle is locked before reversing.



Self-steering axle release valve

In standard lowbed vehicles, the stray axle is also locked in the following cases:

#### 3.7.1.1.1. Locking With Lifted Axle Signal

The number of stray axles cannot exceed the number of fixed axles. For this reason, in vehicles with 4 axles, when the 1st axle is lifted, the 3rd axle (vagrant) is automatically locked when the 2nd axle is lifted in vehicles with 5 axles.

#### 3.7.1.1.2. Locking With Speed Signal

In vehicles with a stray first axle, there is a stability problem on the stray axle while the vehicle is cruising at a speed of 30 km/h. For this reason, the first stray axle is locked automatically above 30 km/h.

#### 3.7.1.1.3. Locking The Lifted Self-Steering Axle

If the stray axle is also the lift axle, the wheel should be prevented from hitting left and right when the axle is lifted. For this reason, the stray axle is automatically locked when the axle is lifted.

### 3.7.1.2. Unlocking the Self-Steering Axle

The stray axes, which lock automatically when reverse gear is engaged, will automatically unlock when the vehicle is moving forward.

To release the manually locked stray axle, turn the valve handle 90° (2) clockwise or move the button to the open position.

 **Vehicles with manually locked stray axes must be unlocked manually. Axle lock will not automatically unlock.**

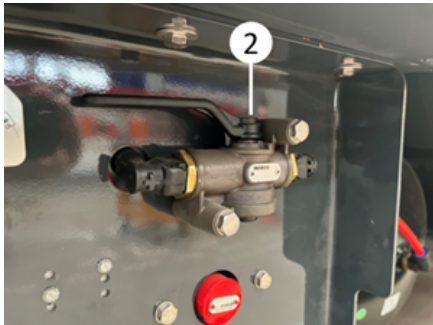

*Self-steering axle release valve*

### 3.7.2. Axle Lifting

Axle lifting feature is offered as an option in your vehicle in different quantities and locations. It is given with an automatic or manual option according to the customer's request.

Thanks to this feature, tire wear is minimized and a more balanced load distribution on the tractor can be achieved. The EBS connection must be active for the axle lift to work.

In the automatic axle lifting system, some axles can be lifted automatically when certain conditions are met:

- When the determined speed is exceeded while EBS is active,
- In case the load on the axles is less than the maximum allowable axle load

It may be necessary for the operator to intervene manually in the axle lift with the help of traction aid or maneuvering aid.

 **In order for the launch assist to be activated (raising the axle), the vehicle must move slower than 30 km/h and the technical capacity of the remaining axles must not exceed 30%.**

When the vehicle is stationary, it is possible to activate the traction help by pressing the tractor brake pedal 3 times in a row.

If your vehicle have optional axle lifting feature from tractor cabin, it is possible to manually lower/ raise the axle lift with a spring loaded button to be installed in the tractor cabin. For this feature, your tractor must be adjusted according to the tractor.

It is also possible to activate /deactivate the axle lift with the help of the button on the trailer. Driving assistance can be activated by pressing and holding this button for less than 5 seconds. If it is pressed more than 5 seconds, the axle can be lowered to the ground.

You can also find information on how to use the axle lift control on the driving aid sticker on your vehicle.



As a result of intervention in the axle lift parameters, your vehicle may be out of regulation. For this reason, the EBS modulator should not be interfered with except authorized services.



*Axle lift button on control cabinet*



*Axle lifting*



**There is a danger of being pinched and injured while lowering / raising the axle.**

### 3.7.3. Hubodometer

Hubodometers show the distance traveled by the vehicle in kilometers or miles.

The unit of the hubodometer is written on the hubodometer. It is adjusted according to the tire diameter.



*Analog Hubodometer*



*Digital Hubodometer*

### 3.8. Tires

When you are choosing tires, the first criteria are the load capacity index. Be sure that the load capacity index is suitable for your vehicle.

Tire manufacturers produce different types of tires according to the purposes of their use such as highway use, off-road or mixed-use. Please choose the correct type of tires according to the road conditions that you will use the vehicle. Choose the low decibel as soon as possible version. Tires as possible as having to Class A fuel efficiency level and braking on wet surfaces according to EU tire label stickers.



**You can see the EU tire labels of the tires which were used in your vehicle on our website.**

In dual/twin line wheeled vehicles, the tires must be matched properly according to their diameters. The tread depths on the adjacent tires shall not be different more than 5 mm. Furthermore, the newly coated tires and partially worn tires shall not be used side-by-side in relation to the structure and type of the vehicle. Otherwise, driving safety will be disrupted. In such tires, though the tread depths are seen, it must be deduced that the tire diameters are different and the tires exceeding the radius differences by 10 mm must not be used side-by-side.

Wrong matching will lead to excess shape deformation of the larger tire by carrying more load than necessary. In such a case, the wearing will accelerate and reveal the risk of early wearing of the tire. This case must be considered whenever radial and transverse layered tires are used side-by-side.



**In some countries, M+S (Mud and Snow) or 3PMSF (3 Peak Snowflake) labelled stickers can be mandatory according to season. Please observe the regulations and rules.**



*M+S and 3PMSF Symbol*



**Very serious accidents may occur if unsuitable or worn tires are used.**

### **3.8.1. Tire Pressure Monitoring System (TPMS)**

It is a Tyre Pressure Monitoring System that increases fuel efficiency and extends tyre life in accordance with the R141 Regulation. In case of tyre pressure differences, it shows the low pressure tyre on the truck. OptiTire helps the driver to reduce fuel costs by providing constantly updated tyre pressure information from each monitored wheel.

A Tire Pressure Monitoring System (TPMS), which complies with regulations and helps improve fuel efficiency and extend tire life, may be available on your vehicles. In the event of an increase or decrease in tire pressure, and if the tractor unit is compatible with this system, a warning light will appear on the tractor's display.

Thanks to this system, sudden changes in tire pressure can be monitored instantly, helping to prevent potential risks. By keeping the tire pressure under control, it enables savings on fuel and fuel-related costs. It reduces emissions and helps extend the service life of the tires. It also allows the vehicle to accelerate more easily and contributes to improved overall performance.



Please inform your service provider about the sensor during tire replacement or repair. Otherwise, the sensor may be damaged.



The vehicle must always be used with the original tire size. If any changes are made to the wheel or tire size, you may need to contact an authorized service center to have the TPMS recalibrated.



The theoretical lifespan of tire pressure sensors is 5–7 years. This is because the sensors are exposed to corrosion, shocks, and high speeds during highway driving. In the event of a malfunction, you should contact a professional to have the faulty tire pressure sensor replaced.



Your spare tire may not be equipped with a tire pressure sensor. Therefore, when the spare tire is installed on the vehicle, the tire pressure sensor from the removed tire should be transferred to the newly installed tire and recalibrated accordingly.

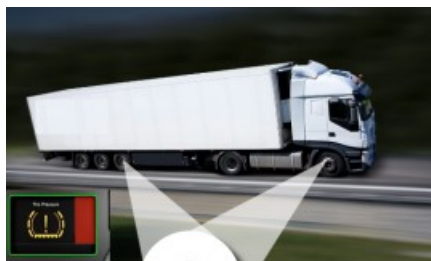

TPMS

TPMS

## Benefits

- Sudden changes in tire pressure can be monitored instantly and risks can be prevented.
- It allows you to save fuel and fuel costs by keeping tire pressure under control.
- It reduces emissions.
- It helps to extend the life of tires.
- It provides easy acceleration of vehicles and helps increase performance.

## How to set TPMS?

You don't need to do anything special, because the warning system is set to the optimum pressure for your tires. When one of your tires is underinflated (i.e. its pressure is less than 20% of the recommended pressure), a light will appear on your dashboard. This is your TPMS, indicating that the tire on your vehicle is affected.

## When should TPMS be recalibrated?

If you choose a different tire size, it is possible that the recommended pressure may differ from the original tire.

In this case, a professional will need to recalibrate the TPMS so that it alerts you to any pressure drops with this new configuration.

## Tire pressure sensor replacement

The theoretical life of tire pressure sensors is 5-7 years. This is because tire pressure sensors are exposed to corrosion, shock and high speed during highway driving.

In case of a malfunction, you can contact a professional to replace the faulty tire pressure sensor.

## 3.9. Spare Wheel Holder

Lowbed standard vehicles have 2 types of spare wheel carrier options:

- Single spare wheel carrier

- Double spare wheel carrier



*Single spare wheel holder*

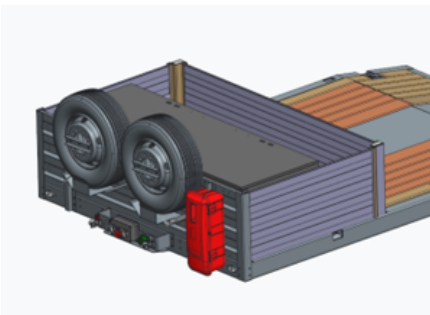

*Double spare wheel holder*



**Make sure that you put the necessary warning signs and take the safety precautions during the tire change.**



**Driving with insufficiently secured spare tire(s) can cause traffic accidents.**



**Since tires are heavy parts, pay attention to ergonomics and occupational health and safety rules during tire replacement. There is a risk of pinching, falling, and cutting.**



**For whatever tire the spare tire carrier is designed for, carry only that type of tire in the carrier. Follow the rules and regulations when removing/installing or maintaining the spare tire or regarding the spare tire carrier.**

### 3.10. Spare Tire Lowering Crane

The crane system is used to lower the spare tire and is supplied upon request by the customer.

- Attach the carabiner at the end of the crane rope to the rim of the spare tire.
- Wind the rope by turning the mechanism handle on the crane. The raised tire will come out of its slot.
- Turn the crane arm until the tire is out of the vehicle.
- Open the rope by turning the mechanism handle on the crane. The tire will go down.
- Remove the carabiner at the end of the rope from the rim.
- Collect the rope by wrapping it on the crane again. Attach the carabiner to the fixing pin on the rear of the spare wheel.





*Spare tire lowering crane*

### 3.11. Wheel Chock

There are two units wheel chocks and holders in the vehicle.

 The vehicle must be secured with wheel chocks when parked on a slope area, during the loading and unloading operations or when parked without a tractor.

 Only place wheel chocks on wheels on fixed axles, never on idle/steer axles.

 When the wheel chocks is fixed inside the holder, be sure that the pins will be mounted properly.

 After driving operations, place the wheel chocks properly.

#### 3.11.1. Pin Type Wheel Chock Holder

**Removing the wheel chock from holders:** Pull out the cotter pin (1) located at the end of the wheel chock holder. Then take the wheel chock from its slot by pulling it sideways from the wheel chock holder.

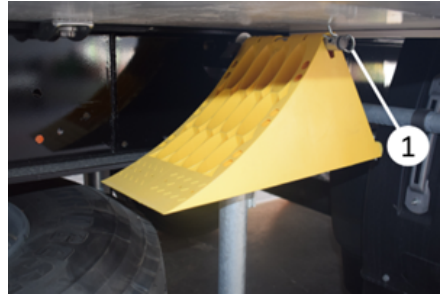

**Placing the wheel chock from its holder:** Place the wheel chocks on the holders and mount the cotter pin (1) to pin.

#### 3.11.2. Pocket Type Wheel Chock Holder

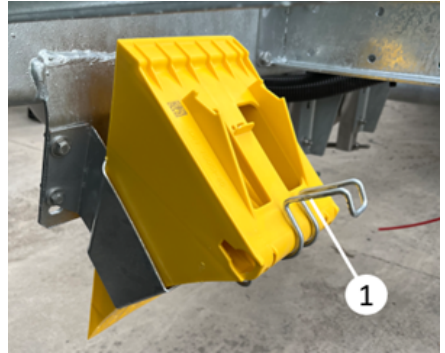

**Removing the wheel chock from holders:** Remove the wheel chocks by pushing the handle (1) which is located at the end of the chock's holder from the wheel chock to the other side.



*Removing the wheel chock from holders:*

**Placing the wheel chock from its holder:** Insert the wheel chock by pulling the handle (1) which is located at the end of the wheel chock's holder.

### 3.11.3. Folding Wheel Chock

These are additional wheel chocks supplied upon request, in addition to the standard wheel chocks already available on the vehicle. Since they are foldable, they can be stored without taking up much space. They are generally kept inside the vehicle's tool/storage compartments.



*Folding Wheel Chock*



*Folding Wheel Chock*

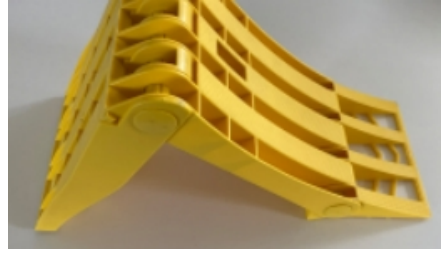

*Folding Wheel Chock*

### 3.12. Boxes and Storage Units



**Be sure that the boxes and storage units are properly closed and that the materials inside of these storage units are fixed properly before driving. Otherwise, the accident may occur.**



**Be sure that the necessary safety measurements are taken while using the cabinets and storage units.**

#### 3.12.1. Steel Toolbox

Used for tool storage. It is usually mounted on the driver's side of the vehicle.

#### Unlocking the Toolbox:

- Insert the key into the lock and turn it to the unlocked position.
- Pull the lock lever back and open the cover by turning it.



*Çelik takım dolabı*



Steel toolbox

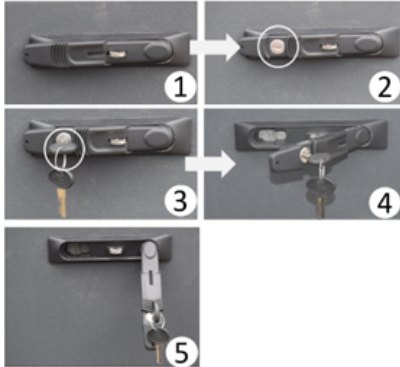

Steel toolbox (Opened)

### 3.12.2. Gooseneck Corner Chamfered Tool Cabinet

If the gooseneck of the vehicle is chamfered, a 3-door tool cabinet can be provided according to the customer's request.

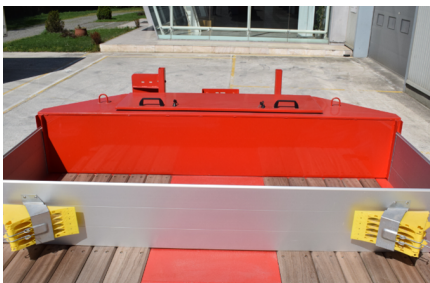

Gooseneck Corner Chamfered Tool Cabinet



Cabinet side doors

#### 3.12.2.1. Opening The Top Of The Cabinet

- To open the top door of the cabinet, the locks (1) shown in the picture are unlocked by turning them clockwise.

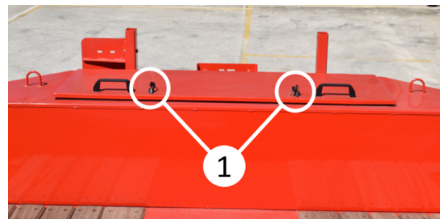

Installing The keys of The top cover

- By turning the lock latch, the locks of the cabinets are opened.
- To open the cover, handles (2) are held and lifted upwards. The cabinet door is opened.

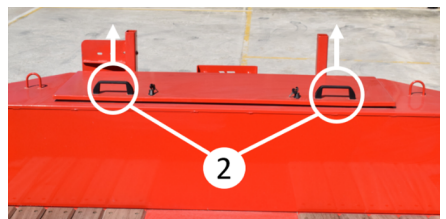

The position of the levers on the cover and the direction of lifting



*Opened cabinet door*

### 3.12.2.2. Opening The Cabinet Side Doors



*Side Door*



*Side cover lock and latch(1)*

- Pull the latch (1) on the side cover lock and remove it.
- Turn the removed latch clockwise (2). The cover has been opened.



*Removing and turning the latch*



*Opening the corner door*

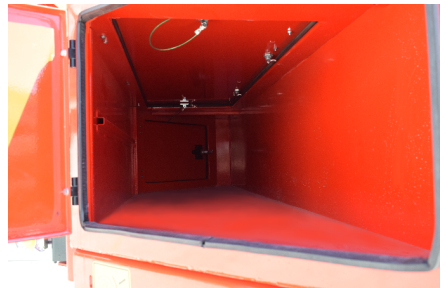

*Inside of The cabinet*

### 3.12.3. Fire Extinguisher Cabinet

Fire extinguisher cabinets are used to protect fire extinguishers from the external environment.



**Maintenance of fire extinguishers should be done regularly and expiry dates should be observed.**

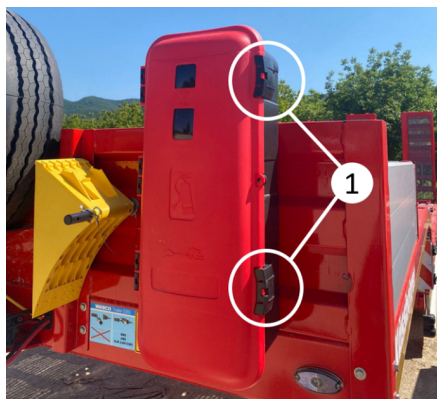

*Latches of fire extinguisher cabinet*

### Opening door

- Open the two plastic latches (1) holding the cover.
- Lift the latch up and back and unlatch the cover to open it.
- Open the Velcro that fastening the fire extinguisher and take the fire extinguisher.

### Closing door

- Place the fire extinguisher and fix it with Velcro.
- First, close the lid and close the latch on the lid.
- Lock the latch to tighten the cover.

### 3.12.4. Pillar Storage Cassette

Pillar storage cassette is given as an option upon customer request.

Pillars are stored in this cassette holder.

Safety pin number 2 must be removed for insertion or removal of the pillars.

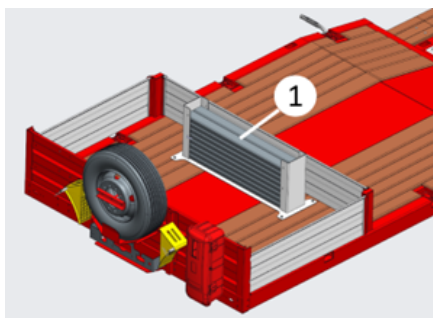

*Pillar storage cassette*

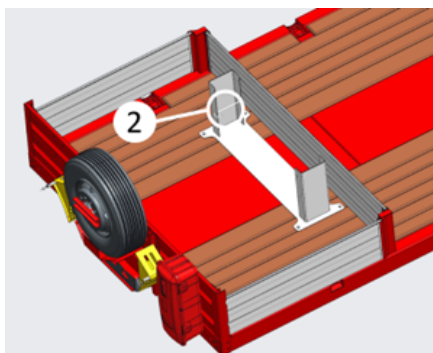

*Pillar storage cassette pin*

### 3.12.5. Ramp Storage Cabinet

Ramp storage cabinet is optionally available in vehicles according to customer request. It is used for stocking portable aluminum ramps. The cabinet can be used from both the right and the left of the vehicle. Double-sided cover is available.

- Turn the lock shaft on the cover so that the lock shaft comes out of the slot.
- Open the cover and slide the ramps on the polyamide material.
- Place the aluminum ramps in the cabinet as double layers.
- Turn the lock shaft by closing the cover and make sure that the shaft enters the lock slot.



*Ramp storage cabinet*

### 3.12.6. Wood Storage Cabinet

Wooden storage cabinet is given as an option according to the customer's request.

It is used for stocking the wood placed on the expansion brackets in the lowbed vehicle.



*Wood storage cabinet*

The woods are placed in the closet as in the image:



*Image of placed wood*

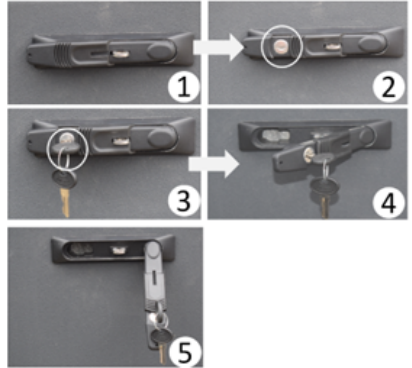

*Opening of wood storage cabinet*

### 3.13. Bumper

Kaessbohrer Low-bed vehicles have one type bumper, that is fixed bumper.

On the bumper, there are reflectors, labels, spotlight, headlight assembly and horn lamps connected to the headlight assembly, parts necessary for ramp use and a mat attached to the bumper.

The bumper is welded to the chassis and provides ease in the use of ramps and the transition between ramp types, as it has an omega shape structure.



*Fixed bumper*

### 3.14. Flooring

It varies according to customer request in Low-bed vehicles:

- Wooden Floor
- Grid floor

### 3.14.1. Wooden Floor

On the floor, hard wooden floor is used. In the axle area, there is a chequer plate on the up-per part of the wheels. It is fixed to the chassis by applying a base screw to the wooden floor.

There is no woods on areas of load rings and container locks (Option).



*Wooden floor*

### 3.14.2. Grid Floor

There is a grid floor made of galvanized steel material. In the axle area, there is a chequer plate on the upper part of the wheels.

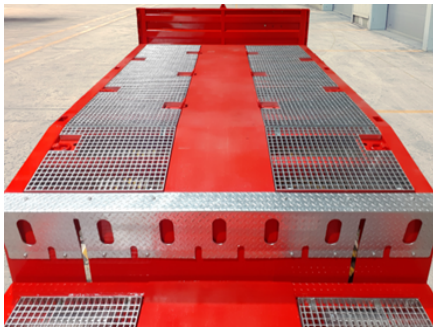

*Grid floor*

## 3.15. Loading Ramp

Ramps are diversified according to their length, width, base types, working and usage patterns.

Ramp varieties:

- Hydraulic system operated ramp
- Hydraulic gooseneck ramp

- Portable ramp

There is a two different motion on ramps:

- Up and down movement of the ramp.
- Right and left movement of the ramp.

### 3.15.1. Hydraulic System Operated Ramps

Ramps operating with hydraulic system vary according to customer request; Ramp type, ramp capacity, ramp floor type etc.

Up and down movement of hydraulic ramps is done with help of hydraulic system.

In lateral movements, it is divided into two as mechanical and hydraulic according to customer request.

#### 3.15.1.1. Ramp Types

##### 3.15.1.1.1. The Folding Ramp

It is the preferred type of ramp to reduce the loading angle.

Thus, it provides the opportunity to load lower loads on the vehicle.



*The Folding ramp*



*The Folding ramp*



*The Folding ramp*

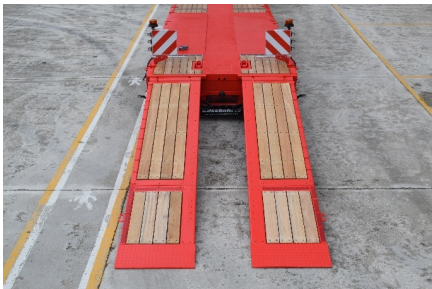

*The Folding ramp*

### 3.15.1.1.2. The Single Ramp

It is preferred for loads that do not have a problem with the loading angle.



*The Single ramp*



*The Single ramp*

### 3.15.1.1.3. The Wide Ramp

It is wider than other ramp types.

It is preferred for loads with wider wheels and middle positioned wheels.



*The Wide ramp*



*The Wide ramp*

### 3.15.1.2. Ramp Floor Varieties

There is two different type of floor.

- Hard wood floor
- Galvanized steel floor

#### 3.15.1.2.1. Hard Wood Floor

This floor type is used as a abrasion layer. Repair is not needed unless something happened to transport feature.



*Hard wood floor ramp*



*Hard wood floor ramp*



**if the woods are harming to transport feature or preventing transportation, change the woods. Do not repair them with add wood on it.**

#### 3.15.1.2.2. Galvanized Steel Grid Floor

The galvanized steel floors not-slipper feature is better than hard wood floor.



In this type of ramps, a protective layer should be placed on the grid floor in steel pallet vehicle loading. Pallets can damage to nails of galvanized steel floor, during loading.



Galvanized steel grid floor

### 3.15.2. Portable Ramps

The portable ramps are one-solid pieces to use on loading ramps or on goose-neck area. Ramps can be used by attaching to the ramp nails located in the bumper area or the goose neck area when desired.

As a customer request, ramp storage cabinet can be given to hide ramps.

#### 3.15.2.1. The Ramps That Usable On Bumper Area

The aluminium ramps (1) that usable on bumper area, provide to heavy machinery to up from bumper zone.

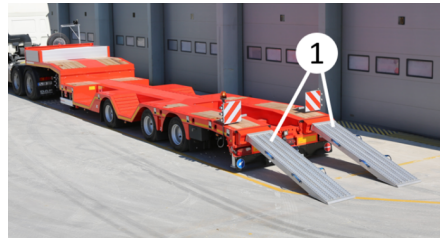

The aluminum ramps that usable on bumper zone



The aluminum ramps that usable on bumper zone

This ramp type are placing to nails (2) that on bumper zone.



The nails that on bumper zone to place ramps

#### 3.15.2.2. The Ramps That Usable On Gooseneck

The ramps that usable on gooseneck (3), provide to usage of gooseneck to carry heavy machineries.

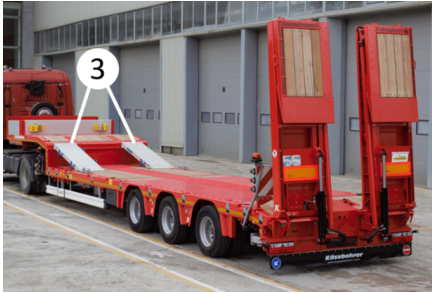

*The aluminium ramps that usable on gooseneck*

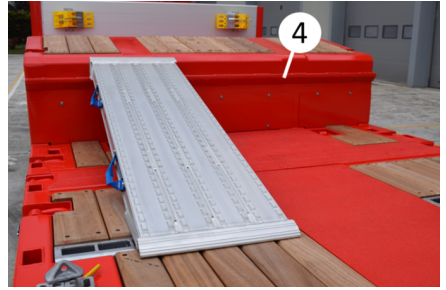

*The nails that on gooseneck*



*The aluminium ramps that usable on gooseneck*

Portable galvanized steel ramps can be given as a customer request.



*Portable galvanized steel ramp*

This type of ramps, can be placed to the nails of gooseneck (4) that on side of looking to bumper.

### 3.15.3. Hydraulic Gooseneck Ramp

The situation that portable ramps are not enough, to increase the loading area on gooseneck zone, hydraulic gooseneck ramp can be given as a customer request.



*Hydraulic gooseneck ramp*

#### Usage of hydraulic gooseneck ramp:

Energy connections (Rema or NATO socket) are made to use the hydraulic gooseneck ramp.

- The safety pin shown in the picture is removed.



The safety pim



The location of the safety pim



The control panel

- The electric hydraulic pump is operated by pressing the button (1) on the control panel, shown in the picture.
- With the hydraulic control valve lever (2) shown in the picture, the platform is brought to the desired position by moving it up or down.
- After it is brought to the desired position, the safety pin is reattached.

 When it is placed in the upper or lower position, it should not be loaded before the safety pins are attached!



The lower position of ramp



The upper position of ramp



The example of usage of hydraulic gooseneck ramp

### 3.15.4. The Extension Bridge

On extendable Lowbed vehicles, After the vehicle extended, the extension bridges are used to take wheeled loads on gooseneck.

The length of the extension bridges are changing according to customer request.

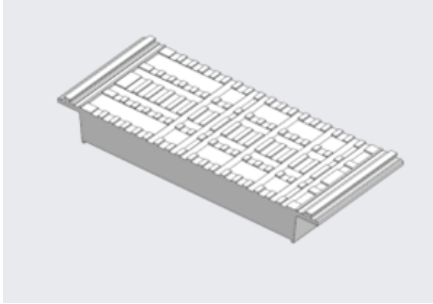

*Extension bridge*

### Usage of The extension bridge:

The vehicle is extended as the length of extension bridge.

The aluminium bridge is placed to opened space.

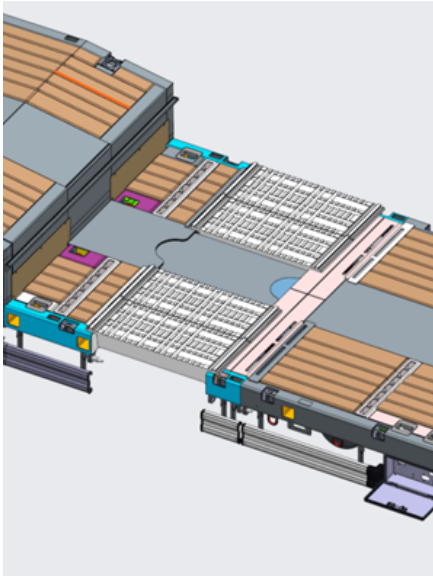

*The placed extension bridges*

### 3.16. Usage Of Hydraulic Ramp

The hydraulic pump feeding energy cable connection is made between the truck and the semi-trailer. Energy cable connections can be made with Rema

socket or NATO socket according to the customer's request.



*Rema socket*

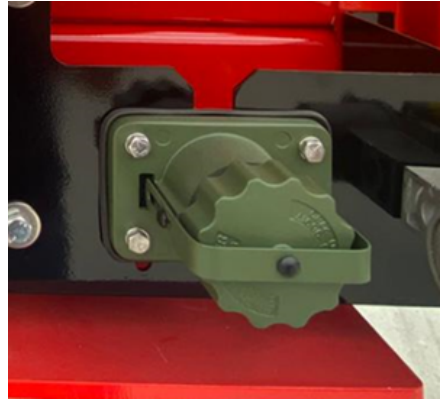

*NATO socket*



*NATO socket cable with battery clip*



NATO to NATO spiral socket cable

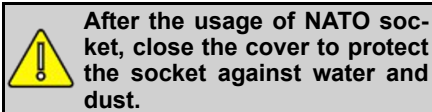

- Remove the ramp chains from both ramps.



The ramp chain

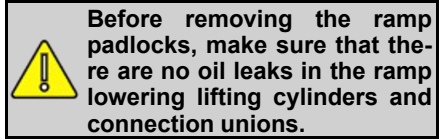
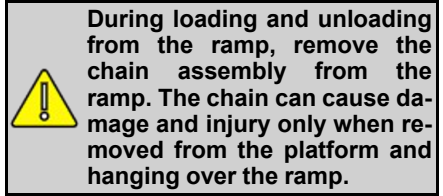

- Open the ramp shift lock to be able to slide the ramps to the right and left at the load level.



Ramp safety lock

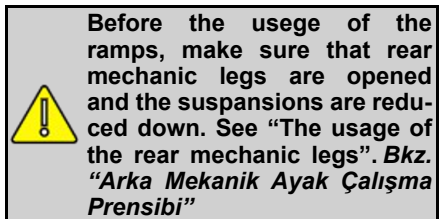

### 3.16.1. Control Of Mechanical Late-ral Sliding Ramps

- Use the holes on the slide consoles to move the mechanical lateral sliding ramps in and out. Perform this operation with the help of the lever provided on the vehicle.



Moving the mechanical ramp with the help of the lever

### 3.16.2. Control Of Hydraulic Lateral Sliding Ramp

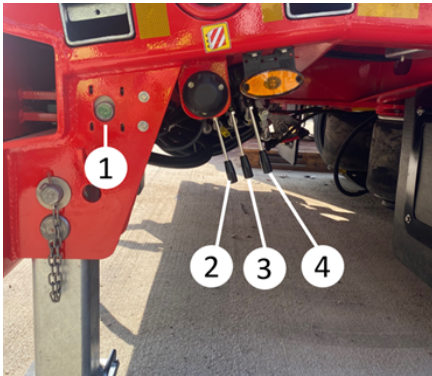

Pump start button and ramp control levers

In order to move the hydraulic lateral sliding ramps in and out, the hydraulic control levers 3 and 4 can be moved up or down according to the desired position by pressing and holding the pump start button shown with the number 1 in the image, as written on the warning label.

3 numbered control lever is controlling the left ramp,

4 numbered control lever is controlling the right ramp.

### 3.17. Lowering The Hydraulic Ramp

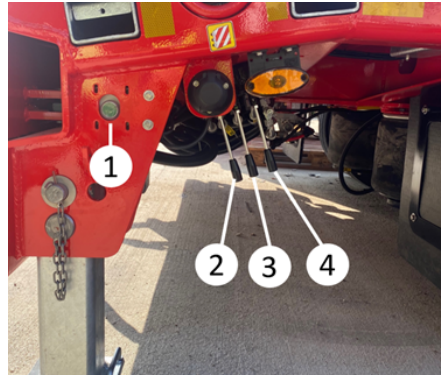

Pump start button and ramp control levers



**Before the usage of the ramps, make sure that rear mechanic legs are opened and the suspensions are reduced down. See “The usage of the rear mechanic legs”**

- For the ramp lowering process, keep the pump start button (1) pressed and move the hydraulic control lever (2) according to the direction of the label and continue the lowering process until the ramp surface rests on the ground.



Lowered version of hydraulic ramp

### 3.18. Lifting The Hydraulic Ramp

 Before the usage of the ramps, make sure that rear mechanic legs are opened and the suspensions are reduced down. See “The usage of the rear mechanic legs”

- For the ramp lifting process, keep the pump start button (1) pressed and move the hydraulic control lever (2) according to the direction of movement described on the label and continue the lifting process until the cycle of the cylinders ends.



*Lifted version of hydraulic ramp*

#### Movement of ramp control levers:

Movement of ramp control levers varies accordingly options. Use the usage label on the vehicle.

 Don't use the ramps for the loads that more than the load capacity.

### 3.19. Ramp Remote Control Function

In addition to the control block located on the vehicle, this system allows the ramps to be operated remotely. After the vehicle's power connections are made (such as Rema, Nato, etc.), the remote control is activated by pressing the power button. Then, using the visual indicators on the remote, the required ramp button can be pressed to move the ramps either downward or upward.



*Ramp Remote Control Function*

### 3.20. The Extendable Chassis

#### 3.20.1. Extending And Shortening / Closing Of The Telescopic Chassis



*Extended Lowbed*



During the maneuver process, The operator must be away from the vehicle's operating field. The lifting / Lowering operations must be done according to commands that given by the lifting vehicle, when the vehicle is stopped.



The maneuvers described below should be performed on flat ground and with the truck moving slowly to the approach position and perfectly aligned with the semi-trailer. With this, abnormal bending of the telescopic chassis or jamming that may cause damage will be avoided.



Telescopic structures are not designed to carry loads. This is showing by special labels. As a general rule, only loads that can be stand on self-feet are carried by telescopic half-loaders.

### 3.20.1.1. Extension Command And Control Components

- Indicator pin
- Pneumatic locking pin switch



Indicator Pin

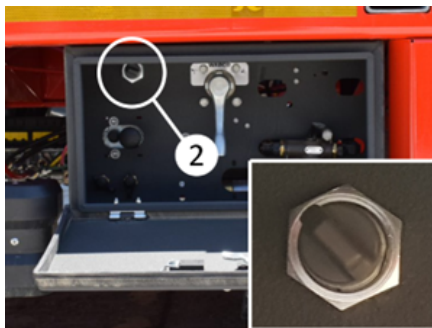

Indicator Pin

### 3.20.1.2. Extending The Vehicle

- Tow the vehicle to flat ground.
- Pull the red PREV valve button (2) that on The vehicle to apply park brake.



PREV valve

- Bring the pneumatic locking pin switch that in command cabinet to open position.

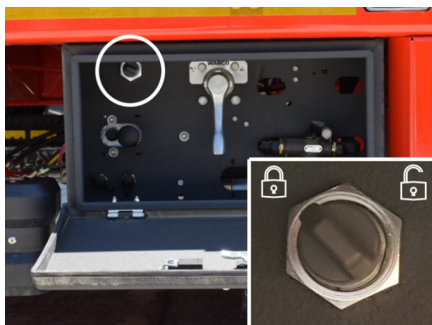

Pneumatic locking pin switch

- It is seen that the lock indicator pin comes out of its socket (3).



*Indicator pin comes out*

The vehicle is extended to the desired position with the help of the truck.



*Extended vehicle*

- To achieve the desired degree of locking, turn the locking pin switch to the off position before the desired distance. When the vehicle continues to extend, the locking pin enters the first slot and locks it. The lock indicator pin returns into the slot (4).

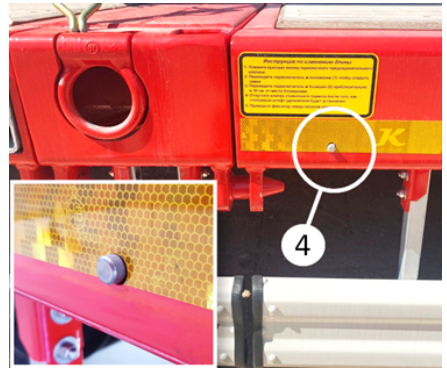

*Indicator pin comes in*

- If any of the pins do not enter into its corresponding slot, move the vehicle by pulling it with the truck unit. To facilitate pin insertion, the vehicle should be slightly turned to the right and/or left while moving.
- After the pneumatic locking pins are in place, press the red button of the PREV valve to allow the vehicle to exit the parking brake mode.
- Before moving the vehicle, visually check that the pneumatic locking pins are fully entered.



**The maneuvers described below should be performed on flat ground and with the truck moving slowly to the approach position and perfectly aligned with the semi-trailer. With this, abnormal bending of the telescopic chassis or jamming that may cause damage will be avoided.**

### 3.20.1.3. Maneuver Of Closing / Shortening

- Pull the red PREV valve button (2) that on The vehicle to apply park brake.



PREV Valve

- To remove the pneumatic locking pin on the vehicle chassis, turn the pneumatic locking pin switch to the on position. This switch pulls the pins back from their sockets, allowing the inner telescopic chassis to move to extend. The indicator pim comes-out from the semi-trailer and can be seen from the outside.
- Close the telescopic platform with the truck to the desired position.
- To achieve the desired locking, turn the locking pin switch to the off position approximately 300 mm before the desired distance. This ensures that the locking pin enters the first slot and locks when the vehicle continues to be closed. The indicator pim goes back into the semi-trailer.
- If any of the pins do not enter into its corresponding slot, move the vehicle by pulling it with the truck unit. To facilitate pin insertion, the vehicle should be slightly turned to the right and/or left while moving.
- After the Indicator pins are in place, press the red button of the release valve to allow the vehicle to exit the parking brake mode.
- Before moving the vehicle, visually check that the pneumatic locking pins are fully entered.

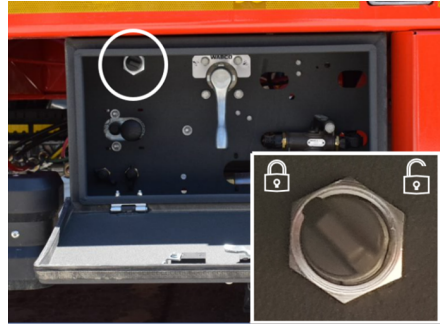

Pneumatic locking pin switch

### 3.21. Wheel-Well Brigge

Wheel-well bridges are an optional feature used on extendable trailers. After the trailer is extended, they are placed between the gooseneck and the platform section for operation. Customers typically choose this option to lower the height of wheeled cargo and keep it within legal transport limits (overall height clearance).



Wheel-Well Brigge

### 3.22. Sliding Platform

The purpose of use of the sliding platform is to prevent the load from flexing when the vehicle is extended while carrying long loads and to create an inter-connection platform for the load.



*Sliding platform*

 **Don't use the sliding platform carry load.**

 **To use the sliding platform, the vehicle must be extended.**

- Pull the locking shaft. The location of the locking shaft showed in picture.



*The locking shaft*



*The location of the locking shaft*

- During the locking shaft is pulled, save the shaft from the nest with rotating right and left.

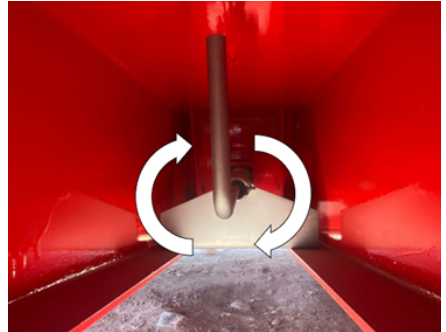

*Rotating the locking shaft*

- Manually push the sliding platform from both sides and move it to the desired area of the extension distance.
- When the desired area is reached, turn the pin of the locking shaft again so that it enters the slot.
- Move the sliding platform backward and forward to make sure that the lock is seated in the lock slots in the extension zone.

### **3.23. Pillar and Pillar Socket**

These are the slots that are positioned on the side raves on the semi trailer, enabling connection from many points with the help of pillars in the transport of different loads. Sizes and quantities may vary according to vehicle specifications.

These slots are optionally given according to the customer's request. The customer can optionally request support pillars.



Pillar socket

### 3.24. Extension Brackets and Woods

#### 3.24.1. Side Extension Brackets

When necessary, the vehicle should be expanded with expansion brackets according to the width of the load to be transported.

The extension brackets have 3 level.

- Lift the latch that in extension bracket to open the lock.
- In the position that latch pressed, pull the extension bracket to yourself.
- When the bracket comes to desired level, release the latch. When the lock placed to nest, the bracket is fixed.
- Place the woods to on brackets and extend the vehicle.
- Open the red-white warning signs that exist on rear-front side of the vehicle.

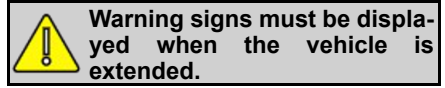

Extension Bracket

A) Extension bracket off

B) Extension bracket on

#### 3.24.2. Side Extension Woods

Side extension woods must be placed on side extension brackets according to labels that on chassis. Side extension woods can be given in panels that on gooseneck area or in storage cabinets according to customer request.

#### 3.24.3. 230 mm Sheet-Reinforced Extension Timber

Compared to standard extension wooden boards, these are more durable and have a longer service life. They can withstand heavier loads. For use, extend the extension brackets to a length of 230 mm and make sure they are locked. Then, place the appropriate steel-reinforced extension wooden board onto the brackets in numerical order.

### 3.25. Lubrication System

Your vehicle may have an automatic lubrication system that allows the axles, steering system and/or tail lift to be steered. For more detailed information about the lubrication system, see the manufacturer's manual.

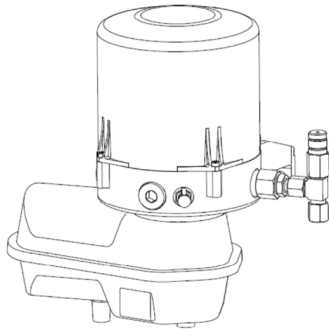

*Lubrication Pump*

### 3.26. Warning Signs

It is used to warn other drivers when the transported loads are wider than the trailer. To use the expansion labels, loosen the 2 thumbscrews on the brackets. Extend the expansion label as long as you want, then slide the expansion label until the holes on the expansion label profile and the fixing bracket match up. When the holes match each other, tighten the wing bolt that meets this hole. Then tighten the contra nut on this bolt for safety. In this way, you fix the expansion label. Then tighten the other wing bolt and tighten the lock nut on it. Thus, you reduce the vibration by taking the space in the expansion label.

Extension markers are used to warn other drivers when the transported load is wider than the trailer.

To use the extension markers, loosen the two wing bolts located on the brackets.

Extend the marker to the desired length, then slide the extension marker until the holes on the marker profile align with the holes on the mounting bracket.

Once the holes are aligned, tighten the wing bolt that corresponds to that hole. Then tighten the locknut placed on the bolt for safety purposes. This secures the extension marker in position.

Afterward, tighten the other wing bolt and then tighten its locknut as well. By doing so, you eliminate any clearance in

the extension marker and reduce vibration.



*Warning signs*

### 3.27. Rotating Warning Lamp

A warning lamp is used to warn other drivers while the vehicle is loaded in traffic. When the parking lights are turned on from the truck, the rotating warning lamp also comes on. There are a total of 4 rotating warning lamp sockets on the vehicle warning signs.

Rotating warning lamp can be supplied as bulb or LED according to customer request.



*Bulb rotating warning lamp*



*Led rotating warning lamp*

## 4. COMPONENTS OF UPPERSTRUCTURE AND USAGE

### 4.1. Overview of Trailer Body Components

The superstructure can be changed optionally according to customer requests.

### 4.2. Front Panel

The front panel is made of steel material.

Each panel is KTL coated and painted according to the vehicle color.

Height can vary according to customer request.



*Front panel*

### 4.3. Side Panel

#### 4.3.1. Side Panel Covers

The Gooseneck area is surrounded by covers made of aluminum profiles. These covers and the pillars on which the covers are placed can be removed from the vehicle when necessary.

Lengths, widths and heights may vary according to customer request.

- Pull the aluminum covers upwards and remove them from the slide.
- Remove the pillars by pulling them upwards from their sockets.



*Side panel covers*

## 5. TRANSPORTATION PROCESS

### 5.1. Pre-Driving Checks

- All necessary documents are in the vehicle,
- Required adjustments and suitability of the loading situation,
- The vehicle is properly tied and secured to the tow truck.
- All pneumatic and electrical connections between the semi-trailer and the tractor are made properly and the EBS system is in working condition,
- All necessary equipment (chocks, underrun protection, ladders, etc.) is in place and properly locked or secured,
- The loads are correctly distributed to prevent displacement while driving,
- The load weight is within the allowable limits,
- The regulations of the country you are in are complied with,
- The lighting and signal system is fully functioning,
- Tire air pressures are at the required level,
- Check that the parking brake of the semi-trailer is released.
- All valves and manhole covers are closed and secured,
- The material hoses are safely lifted.

### 5.2. Semi-Trailer and Tractor Coupling

Apply the following steps to couple the semi-trailer with the tractor:

- Check that kingpin and its couplings are normal . Make sure that there is an adequate amount of grease oil

on the fifth wheel, top-connection plate and kingpin that will prevent damage when coupling and that it does not contain any dust and contaminant.

- Lower the height of the rear suspension airbags of the tractor until it can be inserted in the king pin section of the semi-trailer.
- Set the 5th wheel locking system on the tractor to the "On" position.
- Adjust the height of the semi-trailer to insert it into the tractor. The height of the semi-trailer can be adjusted with the mechanical landing gear. Prevent the movement of the semi-trailer by using the parking brake. Put wheel chock at the rear of the wheels for safety.
- Move the tractor, fifth wheel until it touches the top-connection plate of the semi-trailer and moves backwards slowly on the same level. The fifth wheel will slide smoothly under the top-connection plate and enter the kingpin's shoes and lock automatically with the intensity of impact.
- Raise the landing legs of the semi-trailer and insert the landing legs arm to its place.
- Connect the air, electrical and EBS cables and hoses to their places on the tractor. Be sure that all the functions are working properly.
- If the vehicle has a parking brake, release the parking brake.

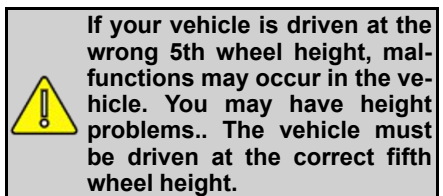

Apply the following steps to uncouple the semi-trailer with the tractor:

- If the vehicle is equipped with service type brake chambers, apply the parking brake after checking the brake drum. Never apply the parking brake when the brake drums are very hot. (The drum may crack.)
- If the vehicle has a hand-brake type brake, put a wheel chock in front of the vehicle. Apply the handbrake.
- Disconnect the brake air lines, the brake will be applied automatically. Disconnect the semi-trailer electrical connections.
- Lower the mechanical landing gear of semi-trailer (use high speed). When the mechanical landing gear feet or wheels touch the ground, switch the mechanical landing gear crank handle to low-speed position to raise the semi-trailer.
- Unlock the fifth wheel lock. Separate the tractor from the semi-trailer about 500 mm by slowly moving the tractor forward. Lower the level of the rear suspension airbags of the tractor and leave the semi-trailer's bottom.

**To ensure that that the king pin is locked properly, engage the first gear of the tractor, and press the gas pedal, when you are slowly releasing the clutch, you will feel that the tractor strives to move the semi-trailer, this indicates that the connection is made properly. During the travel, this connection must be checked carefully to prevent separation of the semi-trailer from the tractor accidentally.**

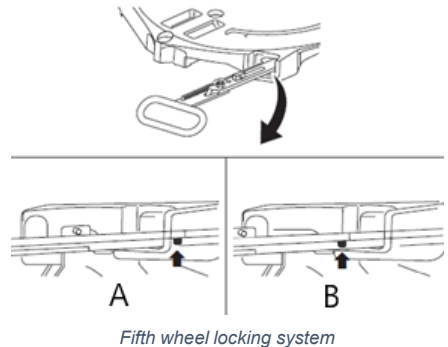



A- Locked

B- Unlocked

### 5.3. Safety Instructions

**Accident hazards arising from loading and unloading and load securing process performed not professionally.**



- Make sure that the cargo is properly distributed and in accordance with all laws, rules, and regulations. Check the loading limits, total weight, and axle load capacities. Do not exceed the weight limits which are defined in the user manual and identification plate. Comply with all national/international laws, rules and regulations about loading and occupational safety.
- Place the Cargo as close as possible to the loading area's floor. The center of gravity of the load must

always be on the center line of the vehicle. Be all the regulations and laws about load security.

- While all vehicles are being designed, except for specific ones, it is assumed that the load will be distributed evenly on the load carriage surface and the calculations are done accordingly. Thus, the load up to the maximum carrying capacity of your vehicle must be distributed to ensure that equal weights are at the unit areas over the utilized carriage area. When the point loads are to be carried, a rigid distribution platform must be placed under the load that will place the load up to the unit area capacity of the semi-trailer.
- While loading by crane or forklift, make sure that there is no one under and around the load.
- During the loading operation, do not exceed the permissible maximum height. A loading performed within the specified loading limit will ensure that you keep away from traffic accidents.
- It is dangerous and prohibited to fix the load to the vehicle surface via a tool apart from the permissible equipment.

#### **5.4. Cautions During the Parking and Stopping**

- Involuntary trailer movements, unstable posture and insufficient safety at night may occur serious accidents and injuries.
- Use the parking brake and wheel chocks while stopping.
- If you are going to park the vehicle in a public traffic area, you must use the necessary marking plate in accordance with legal regulations.

#### **5.5. Loading**

- The load must be fixed properly. Otherwise, the load may be moved during transportation or emergency brakes.
- Place the Cargo as close as possible to the loading area's floor. The center of the gravity of the load must always be on the center line of the vehicle.
- The load must be fixed with straps or load securing profiles. Be sure that the load is fixed safely.
- After the loading operations, be sure that all the components are suitable for the transportation.

#### **5.6. Important Technical Considerations**

##### **5.6.1. Fire Extinguisher**

Please check fire extinguishers periodically every year and fill them up if necessary. In case of any usage of the fire extinguishers, fill it up immediately.

##### **Precautions to be taken in case of fire.**

Some sealing materials let out gas when burned and these gases may become abrasive acid in contact with water. Thus never touch the fire extinguisher liquid accumulations without wearing protective gloves.



*Fire Extinguisher Box*

### 5.6.2. Wheel Chocks

Keep the wheel chocks in their place and place them under the wheels during parking. Do not forget to remove the wheel chocks before setting off.



*Wheel Chocks*

### 5.6.3. Modifications on the Trailer

Repairing and modification operations must be made by only authorized services. Otherwise, your vehicle may be out of warranty.

### 5.6.4. Air Leakage

In case the air pressure in the air tubes drops instantly with the engine stop, this means that there is a leakage in the pneumatic system. Contact the nearest authorized service in such a case. The air leakage not only affects the safety of the braking system but also negatively affects the load lifting capacity of air-bags.

### 5.6.5. Considerations For the Environment

Pollution in all its forms poses a threat to the environment. To keep the pollution at a minimum, collect the waste materials carefully and dispose of them in accordance with the regulations of your country.

**ENVIRONMENT** - Disposal of the battery in an inappropriate place may harm the environment and human health. If you need to dispose of the battery, follow local regulations. If you do not know how

to dispose of it, take it to the most appropriate service point. The symbol on the battery indicates that this product should not be disposed of.



### Health and Safety

- Keep sparks and fire away from the battery. The battery emits explosive gas that can cause an explosion.
- Wear eye protection and rubber gloves while working on the battery, otherwise the battery hand-control may cause burn and serious damage including blindness in your eyes.
- Under no circumstances allow children to handle the battery. Make sure that anyone dealing with the battery is familiar with the proper use of the battery and its hazards.
- Pay close attention to the battery electrolyte as it contains diluted sulfuric acid. Contact with your skin and eyes may cause burns or loss of eyesight.
- Carefully read and understand this manual before working on the battery. Failure to follow instructions may result in injury and vehicle damage.
- Do not use the battery if the electrolyte level is at or below the recommended level. Using the battery with a low electrolyte level can cause explosion and serious injury.

**If there are wasted oil and wasted oil contact materials in your vehicle, pay attention to the following warnings.**

When disposing of products/wastes such as used oil, hydraulic oil, do not discharge into channels, sewers, landfills, or soil. This is against the legislation of all countries.

This rule also applies to empty containers in contact with oil, chemical materials, and waste of cleaning cloths. Take these wastes to the relevant authorities or the most appropriate service point for disposal.

#### **If your vehicle tire has expired;**

The end-of-life tire must be disposed of in accordance with the regulations. For this, take your expired tire to the relevant authorities or appropriate service points.

#### **If you carry dangerous chemicals in your vehicle;**

In case of an accident or emergency that may occur during transportation, act in accordance with the Written Instructions of the ADR Legislation.

From the trailer's life-cycle perspective, it is important to recycle the end-of-life vehicle in an environmentally friendly manner. A large part of the trailer consists of recyclable materials. Contact the approved company and appropriate service for the recycling of the trailer that has expired.

### **5.7. Cleaning the Vehicle**

Before starting to clean the vehicle, check the hub and axle lifter for leaks. These may not be visible after the cleaning process is complete. Pay special attention to the following when washing with pressurized water:

- Do not hold the hose nozzle directly to the felts while washing with pressurized water.
- Do not hold pressurized water to the electrical components and connections of the vehicle.
- The vehicle should be washed by holding a maximum 240 bar pressure washer at a minimum distance of 1 m and at a maximum angle of 45 degrees in order not to damage the vehicle logo and paint.
- After cleaning the vehicle, carefully lubricate the greasing points with a grease gun. This is important to prevent dirt and moisture from entering various parts of the vehicle.
- Clean the interior and exterior of the vehicle every time you return.

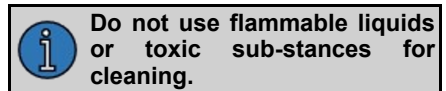

## 6. TRANSPORTATION SOLUTION

### 6.1. Container Transportation

#### 6.1.1. The Container Locks

The vehicle may have a container lock as an option. These locks are positioned on the platform for container transport on the semi-trailer.

Locks are unlocked by turning the star under the container lock. Container slots are placed on the locks. After the container is seated, the star under the lock is pushed upwards, turned and locked.

Container locks may vary according to the country options of the vehicles.



Container locks

20 ft, 30 ft, 40 ft and 45 ft container transport modes:

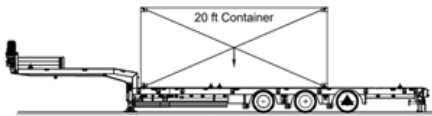

20 ft container on the middle

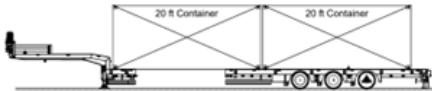

Carriage 2 piece 20 ft container

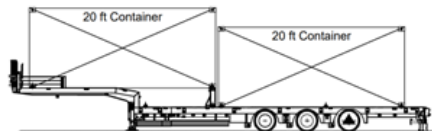

Carriage of 2 piece 20 ft container on gooseneck

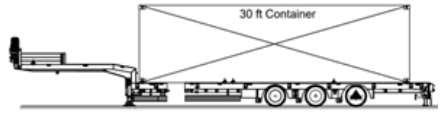

Carriage of 30 ft container

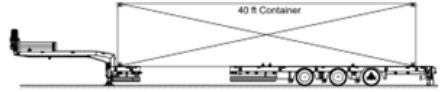

Carriage of 40 ft container

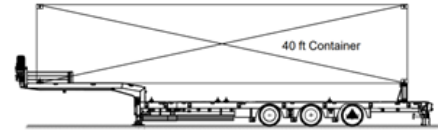

Carriage of 40 ft container on gooseneck with loading table

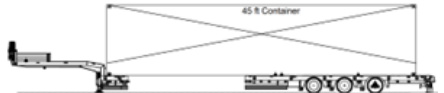

Carriage of 45 ft container

### 6.2. Heavy Machinery Transport



It should be noted whether the heavy machinery to be transported is suitable for the trailer.



Make sure that the center of gravity of the heavy machinery is correctly loaded on the trailer.



Make sure that the heavy machinery is attached to the trailer with the correct lashing rings.



Example of carrying heavy machinery

## 7. LOADING AND LOAD SECURITY

### 7.1. Safety Instructions



**Accident hazards arising from loading and unloading and load securing process performed not professionally.**

- Make sure that the cargo is properly distributed and in accordance with all laws, rules, and regulations. Check the loading limits, total weight, and axle load capacities. Do not exceed the weight limits which are defined in the user manual and identification plate. Comply with all national/international laws, rules and regulations about loading and occupational safety.
- Place the Cargo as close as possible to the loading area's floor. The center of gravity of the load must always be on the center line of the vehicle. Be all the regulations and laws about load security.
- While all vehicles are being designed, except for specific ones, it is assumed that the load will be distributed evenly on the load carriage surface and the calculations are done accordingly. Thus, the load up to the maximum carrying capacity of your vehicle must be distributed to ensure that equal weights are at the unit areas over the utilized carriage area. When the point loads are to be carried, a rigid distribution platform must be placed under the load that will place the load up to the unit area capacity of the semi-trailer.
- While loading by crane or forklift, make sure that there is no one under and around the load.
- During the loading operation, do not exceed the permissible maximum height. A loading performed within the specified loading limit will ensure that you keep away from traffic accidents.

- It is dangerous and prohibited to fix the load to the vehicle surface via a tool apart from the permissible equipment.

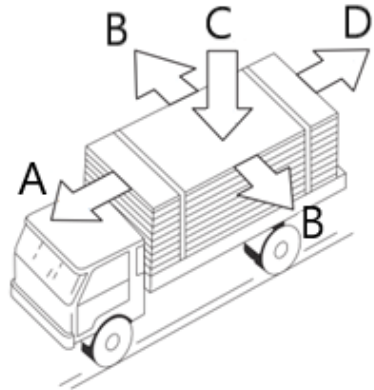

*Forces may affect the vehicle*

- A- Brake Force
- B- Centrifugal Force
- C- Static Weight Force
- D- Ramp / Hill Force

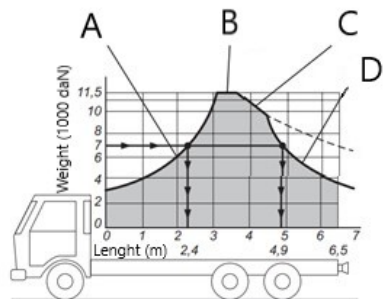

*Load distribution*

- A- Permissible front axle weight
- B- Permissible maximum weight
- C- Permissible rear axle weight
- D- Driving characteristic change limit

#### 7.1.1. Load Security

The international Highways Regulations specify the maximum loading capacities

of tractors, trucks, trailers, semi-trailers along with how and how much of the tonnage and dimensions of these loads are to be secured.

For instance, here, the distribution of the load amount that can be carried by a 6x2 truck per its axle, to the vehicle's weight center according to its horizontal and vertical distance.

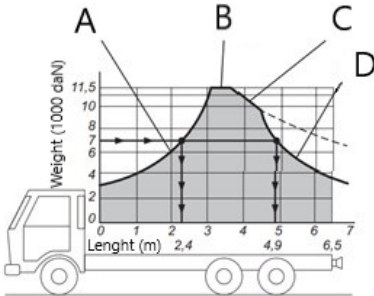

Load Distribution

- A- Permissible front axle weight
- B- Permissible maximum weight
- C- Permissible rear axle weight
- D- Driving characteristic change limit

## 7.2. Load Distribution and Load Limits of Truck-Semi-Trailer Combination

In order to determine the characteristics of the load lashing device required for daily use, the maximum lashing forces have been defined, taking into account the tensile forces encountered during normal driving, emergency braking and sudden steering manoeuvres.

The following two clamping force requirements, expressed as a ratio of the load weight force, shall apply.

Forward lashing (for sudden braking) 0.8 or 80% of the load weight force.

A load with a weight force of 1000 daN must be secured against forward slipping with at least 800 daN.

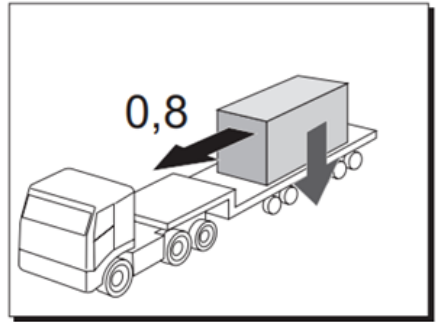

Fastening forward

Backward and lateral fastening (obstacle avoidance/standstill acceleration) 0.5% or 50%.

A load with a weight force of 1000 daN must be fastened with at least 500 daN against shear in these three directions.

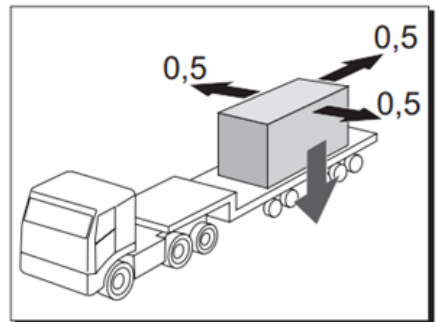

Backward and lateral lashing

### 7.2.1. Downlink Load Lashing

The basic principle of downward lashing is based on applying an additional horizontal connecting force to increase the inertia force to reach the maximum allowable horizontal lashing force (0.8 of the weight force for forward lashing).

#### 7.2.1.1. Lashing the Tie Straps

##### Lashing angle ~90°

Attachment straps should be as perpendicular as possible to ensure that the tension force applied using the ratchet tensioner presses down on the load as much as possible.

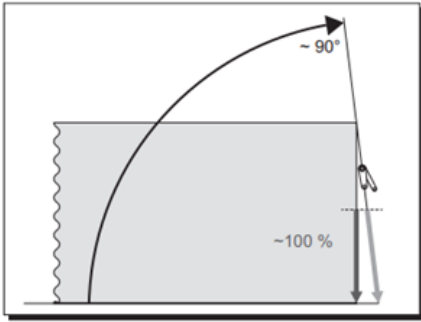

Lashing angle  $\sim 90^\circ$

### Lashing angle $\sim 35^\circ$

At  $35^\circ$ , the effective downward force is only 50% of the applied stress.

Angles below  $35^\circ$  are not effective for lashing.

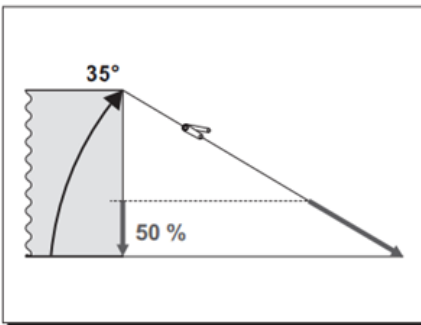

Lashing angle  $\sim 35^\circ$

A protractor (miter) is used, as illustrated, to determine the optimal angle.

The downward force decreases in direct proportion to the angle.

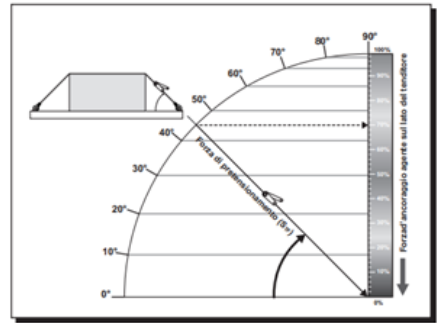

Measuring the angle with a miter

### 7.2.1.2. Using the Lashing System

When attaching the lashing systems, try to apply the highest possible tension force. The higher the tensile strength, the less lashing systems will be needed.



**Always use at least two lashing systems. This will ensure that the load is secured more evenly.**



**For chain selection, see the values on the plates.**

**Kässbohrer accepts no responsibility for connecting equipment.**

Make sure that you make a proper load distribution in accordance with all laws, rules and regulations.

In the loading process, consider the loading limits, the total weight and the load capacities of the axles.

Make sure that you load in accordance with the rules and laws of all countries where you will use the vehicle. Loading diagrams vary according to vehicle type and customer demands. You can request the loading diagram suitable for your own vehicle from our company.

The axle loads\* of the tractor/semi-trailer combination can vary over a wide range depending on the different loading conditions. Observe the permissible axle loads specified in the user manual or the axle manufacturer's manual.

In case of doubt, have your axle loads checked at a suitable weighing station.

**\*Axle load:** It is the load transmitted to the road by an axle or an axle group.



**Unsecured loads can slide or roll on their surfaces. Therefore, effectively secure loads against slipping and tipping over before setting off.**

### 7.3. Lashing Rings

There are lashing rings on the platform and on the side to secure load. These rings can be hidden by embedding.

The load capacities of the rings vary according to the configuration of the selected vehicle.



**An improperly fastened load can cause serious damage to people, animals or property.**



*Embedded load lashing rings*



*Removed load lashing rings*



*Side lashing rings*

### 7.4. Loading Tables

Optionally given as a customer request.

Loading tables make use of the gooseneck area to increase the loading area of the vehicle.

There is two options:

- The loading tables with container lock
- The load carrying tables

#### 7.4.1. The Loading Table With Container Lock

Thanks to the container lock slots under it, it is fixed with the container locks on the platform. The container to be transported is locked with the container lock on the table.



*The loading table with container lock*

#### 7.4.2. The Load Carrying Tables

It is used by placing it in the pillar sockets on the platform. Loads exceeding the platform height also make use of the gooseneck area.

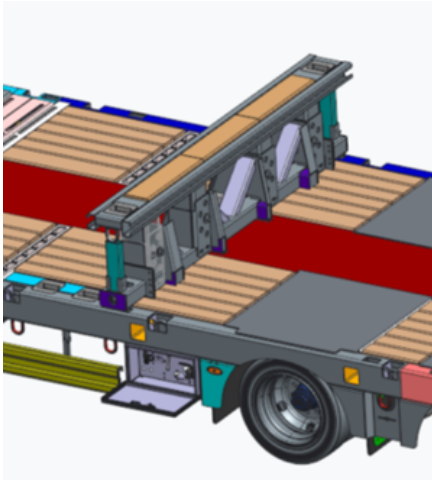

*The load carrying table*

## 7.5. Loading Crane

Our vehicles can be optionally equipped with cranes with lifting capacities of 5 tons or 10 tons. After the vehicle's power socket is connected (REMA, NATO, etc.), the crane is ready for operation. Once the wired control unit socket is connected to its designated port on the crane, both wired and wireless controls can be used. The wireless remote control is stored inside the wired control unit housing. To remove it, gently push the red remote sideways to release it from its holder. The wireless remote control is activated by pressing the power button. Depending on operational requirements, the crane can be operated by pressing the relevant buttons on the control unit.

Loading crane is given as a customer request.

It is preferred for pulling wheeled loads on the platform.

Capacities vary according to customer request.

For detailed usage, please refer to the user manual of the relevant crane manufacturer.



*Loading crane*

## 7.6. Pallet or Platform Transport Instructions

Be sure to support the gooseneck area by placing a suitable support near the fifth-wheel pin and tying it to the pallet or load platform with ropes.

A = Support

B = Rope

C = Landing legs

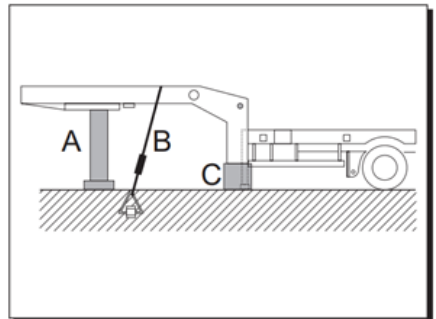

*Pallet or Platform Transport Instructions*

## 7.7. Lowbed Vehicles Loading Instructions

### 7.7.1. Pre-installation Preparations

- While loading to the trailer, do not exceed the values specified in the transport document.
- While loading to the trailer, make balanced loading by taking into account the king pin and axle

capacities specified in the transport document.

### 7.7.1.1. Pre-installation Checks

- Check that the electrical and brake connections on the truck and trailer are made. Make sure that the electric, brake and suspension systems work on the trailer.
- Plan how the loading should be done by providing information about the weight, center of gravity, width and height of the load.

### 7.7.1.2. General Informations

- Before loading, check the kingpin connections between the trailer and truck connections.
- Make sure that the trailer and truck parking brakes are applied.
- Use wheel chocks to prevent the trailer from slipping.
- Do not load on the trailer without the truck attached.

### 7.7.1.3. Protection of Vehicles in the Condition of Preparation and Loading

- Clean the greasy and coarse dirt from the loading area.
- The load must be inserted into the slots of the lashing rings on the platform where the load can hit.
- Remove the lashing rings on the floor.

### 7.7.2. Position of Load

- Take into account the values specified in the technical document and load in a way that does not pose a hazard.
- If the load to be transported is not suitable for the specified loading conditions, make carrying stands under it to spread the load on the vehicle.

- Determine where the load should be placed using the load diagram for extending vehicles.
- Place the load symmetrically with respect to the vehicle axis.

### 7.7.3. Center of Gravity of the Load

For non-extendable type vehicles, make sure that the center of gravity of the load and the center of gravity of the trailer are at the same place.

In non-extendable type vehicles, the distance between the surfaces of the load should be at least 40% of the loading platform.

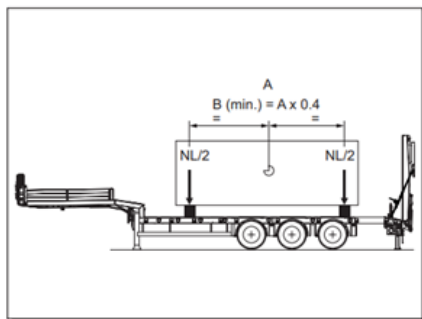

Calculation of the center of gravity of the load

Use the loading diagram for extending vehicles.

### 7.7.4. Loading Diagram

| Extension     | O             | L:         |    |    |       |
|---------------|---------------|------------|----|----|-------|
| King Pin Load | Load per Axle | Total Load | X  | A  | B Min |
| kg            | kg            | kg         | mm | mm | mm    |

5 Axle (3+2) Lowbed Standard Loading Diagram

There is a loading diagram for each vehicle type. Loading should not be done other than the dimensions and tonnages given in the loading diagram. In the loading diagrams, you will see information such as weight from king-pin, weight from axle, total weight.

Using the loading diagram saves you time and ensures that your vehicle is not damaged during loading.

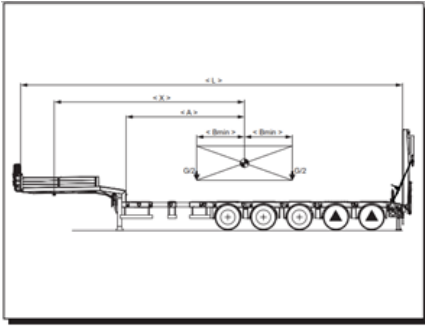

Loading Diagram

### 7.7.5. Loading Surface of The Load

- For extendable and non-extendable vehicles, place the load so that the places where the load will step on are above the cross and at least 2 pieces of cross according to the loading area of the load.



**If load feet come into the gaps between the wheel tops and the crosses, the floor may be damaged and the load may tip over.**

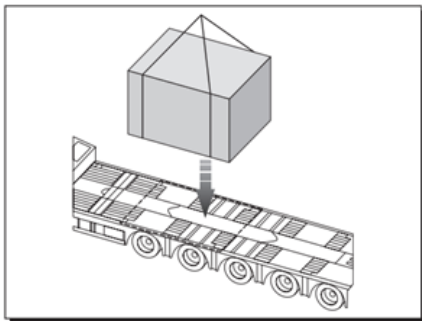

The loading area of load

### 7.7.6. Spread Load Transport

- The load placed on the surface must be symmetrical with respect to the vehicle axis.
- The length of the load must be at least 40% of the loading platform.

- In case the load is not in the specified dimensions, use a loading table under the load.

### 7.7.7. Loading With Two Support

- For extendable and non-extendable vehicles, the load's feet must be on at least 2 cross.
- In case the load is not in the specified dimensions, use a loading table under the load.

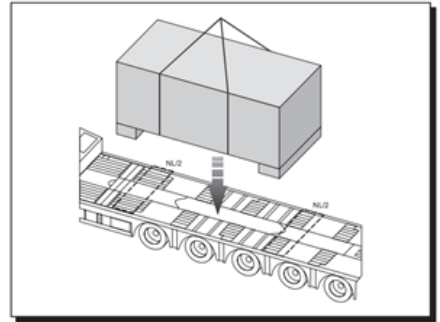

Placing the load

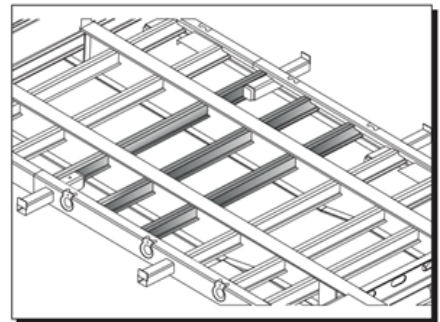

Triple cross placing

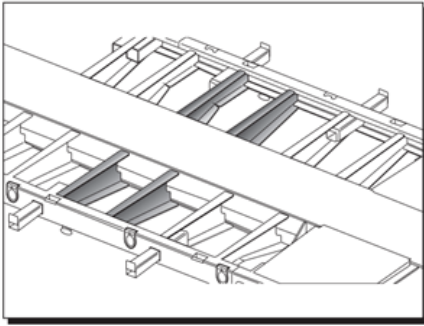

*Double cross placing*

### 7.7.8. Loading With Four Support

- The load feet must be on at least 3 cross.
- In case the load is not in the specified dimensions, use a loading table under the load.

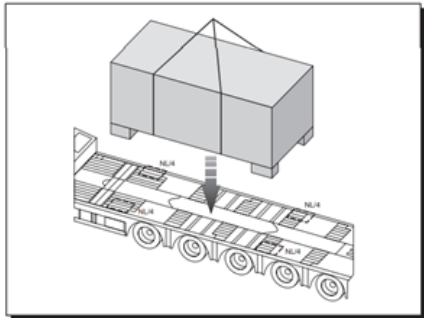

*Loading with four support*

### 7.7.9. Loading at Vehicle That Has Ramp

- Prevent the vehicle from slipping during loading by pulling the emergency valve on the trailer and placing the wheel chocks in front of the tires.
- Open the rear support legs on the trailer and fix them with pins. If the rear support leg is hydraulic, pin fixing is not required.
- With the lowering lift valve, the vehicle should be lowered to ensure that the feet are on the ground. If

the feet do not touch the ground due to the ground, put wheel chocks.

- After width of the pallet or width of the wheeled loads are examined from documents, calculate at what distance the ramp will open in or out.
- When loading on the ramp for wheeled vehicles, the tire pressure dimensions should be minimum (300 mm x 200 mm).
- In the loading of wheeled vehicles, the weight of the single axle should not exceed 50% of the maximum ramp capacity.

### 7.7.10. Extending Type Expansion Bracket Overload

- Do not carry the entire load on the expansion brackets.
- Pay attention to the dimensions given below when loading.



*Expansion brackets*

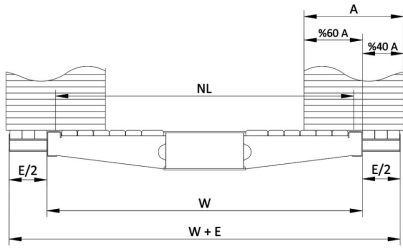

*Installation on expansion brackets*

## 8. INSPECTION AND MAINTENANCE

### 8.1. General Information

All instructions apply to standard vehicle maintenance, lubrication, inspection and standard settings.



To identify the parts, refer to the "SPARE PARTS" manual.

### 8.2. Disposal of Used Materials

During maintenance operations, in case of replacement of parts or oil, old materials (oils, filters, etc.) must be disposed of in accordance with environmental regulations.



Used oil and oil filters contain substances harmful to the environment. After replacing polluting parts, contact an authorized waste recycling center to dispose of used oil filters and oils in accordance with environmental and current laws.

### 8.3. Conditions of the Place where Service and Maintenance Operations are Made



All operations described in this section should only be performed by trained personnel.

- It is strictly forbidden to have unauthorized persons other than maintenance personnel near the vehicle during maintenance operations.
- Because of exhaust gas is dangerous, make sure there is adequate ventilation when the power unit or engine is running in a confined space.
- Unless otherwise stated, maintenance operations must be performed with the power unit turned off.

- You must properly support the vehicle when performing maintenance on the hydraulic lift system.
- You should always use KÄSSBOHRER spare parts.
- For maintenance work, use greases and oils with viscosity values suitable for the relevant ambient temperature and recommended by KÄSSBOHRER.
- Always use clean oil and grease, also make sure the oil containers are clean.
- Always check the oil in a suitable place and change it as necessary. Make sure that no dirt is mixed with the oil.
- It is recommended to wash the vehicle before any periodic maintenance.

### 8.4. Periodic Maintenance and Controls

For periodic maintenance and checks, see the warranty and maintenance manual.

### 8.5. General Maintenance Program New Semi-Trailer

Tightness of wheel nuts;

- After delivery,
- After 50 km,
- After 200 km,
- It should be checked after 1600 km.

After reaching this mileage, it is necessary to check the tightness of the suspension nuts, axle nuts and wheel hub space.

### Semi-Trailers in Normal Use

Special maintenance intervals should be determined according to experience and actual usage conditions. The following

maintenance schedule is valid under reasonable vehicle use and normal operating conditions.

### **Weekly Maintenance Work**

- Check the steering chock.
- Check the fifth wheel pin.
- Check if the brake system is working properly.
- Check tire pressures.
- Check the wheel nuts tightness.
- Bleed the air from the tanks
- Lubricate the vehicle (for vehicles without a central lubrication system).
- Check that grease reaches the points lubricated by the central lubrication system, that the system is working correctly, and that the pump tank is filled with grease (for vehicles equipped with a centralized lubrication system).
- Check the hydraulic oil level in the tank.
- Check the antifreeze valve (if present).

### **Monthly Maintenance Work**

- The oil of the hydraulic system should be changed after the first one or two months of use of the semi-trailer. The hydraulic oil, which is changed after the first two months of use, can be reused if carefully filtered.
- Check the wear of the brake pads.
- Adjust the brakes.
- Check the height adjuster setting.
- Check the alignment of the axles.

- Check the pressure values provided by the braking control.

### **One Time in Three Months Maintenance Work**

- Clean the filter element of the Yellow and Red coupling heads.
- Check the suspension system for wear, oil leaks and damage.
- Check the camshaft clearance.
- Check for leaks in the brake system (with the service brake active).
- Check for air leaks in the air suspension.
- Check the air pillows for damage.
- Check for contamination on the roller surface, clean if necessary.
- Check for wear, scratches and corrosion on parabolic springs.
- Check tire wear.

### **One Time in Six Months Maintenance Work**

- Check the axles.
- Check the bearing clearances.
- Check the pneumatic system components.
- Check hydraulic system components.

### **Annual Maintenance Work**

- Check their suspension (gap adjustment).
- Check the brake chambers.
- Change the hydraulic oil used in the system once a year. (In cases where contamination is observed at earlier periods in hydraulic system oil controls, a 1-year period for

hydraulic oil change is should not waited.)

- Lubricate the drum grease points on the axles with grease nipples at every brake pad change or every 12 months.
- Take your lowbed to the service center for a grease change of the wheel hub bearing after 300,000 km or 36 months of use.

### 8.6. Hydraulic and Pneumatic Hoses and Connections

- After the first month, check all the unions.
- Check the unions again after 6 months.
- These operations should be repeated every time oil or air leaks from the unions.

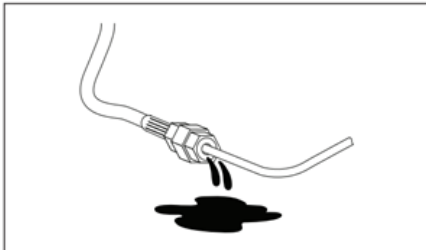

*Oil leakage in hydraulic and pneumatic connections*

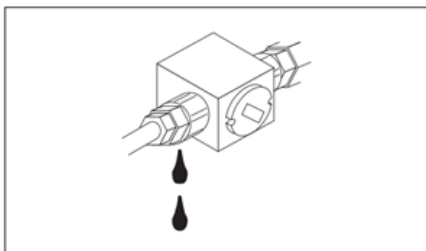

*Oil leakage in hydraulic and pneumatic connections*

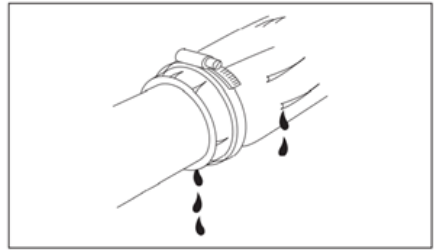

*Oil leakage in hydraulic and pneumatic connections*

**! If oil leakage is detected at the connections, the tank levels should be checked.**

**! Replace hoses every three years to ensure maximum machine safety.**

### 8.7. Tightening Torques for ISO Standard Bolts

Bolts should be tightened using a torque wrench set to the appropriate value. The tightening torque value is used to prevent the bolts from breaking due to tension. The following tables show the tightening torque values (M) for various metric threaded bolt outer diameters. These are approximate values for new and lubricated bolts.

**! The values in the table will be used unless special requirements are shown in the “SPARE PARTS” manual.**

### 8.8. King Pin

#### 8.8.1. King Pin Assembly Bolt

| King Pin | Screw   | Tightening Torque |
|----------|---------|-------------------|
| 2'       | KZ 1516 | M20X50            |
| 3 1/2'   | KZ 1016 | M20X50            |
|          |         | 500 +- 10 Nm      |
|          |         | 500 +- 10 Nm      |

#### 8.8.2. Chagement of King Pin

The King Pin's slot on the gooseneck is suitable for mounting the following pins (alternatively):

## 3" ½ King Pin

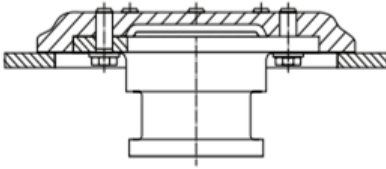

3.5 inch king pin

## 2" King Pin

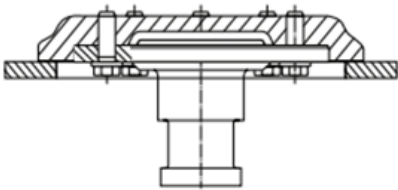

2 inch king pin

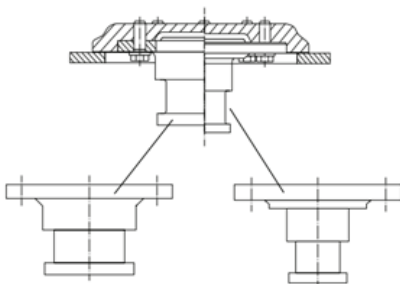

3" ½

2"

Comparison of 2 inch and 3.5 inch king pins



King Pin

Changing the King Pin can be done simply by removing the 8 bolts on it.



After installing the new king pin, apply Loctite 270 to the bolts and tighten to the tightening torque listed in the table above.



Loctite 270

### 8.8.3. King Pin Maintenance

Separate the Semi-Trailer from the truck at short intervals, in any case, it should be applied at most every 5,000 km. Clean the 5th wheel plate and counter plate of the semi-trailer. Lubricate the 5th wheel pin, the counterplate, the closing mechanism and the 5th wheel plate generously with high-pressure grease.



Especially in the first operation of the semi-trailer, abundant lubrication of the 5th wheel pin and 5th wheel is vital for long durability.

The 5th wheel pin is subject to natural wear. When the wear measurement limit is exceeded, the 5th wheel pin must be replaced with an original spare part.

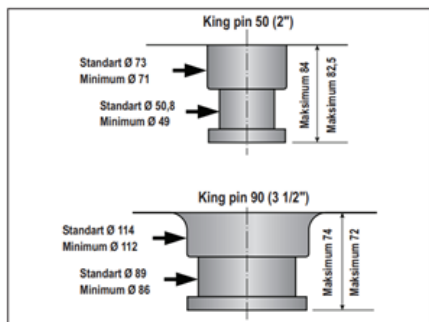

King Pin sizes

### 8.9. King Pin Steering Center Bearing Control

Maximum allowable clearance on King Pin steering center bearing:

- 2 mm in radial (horizontal) direction
- 3 mm in the axial (vertical) direction



If the vehicle is new, the maximum clearance in both directions is 1.5 mm.



When the gap exceeds the values shown, replace the turntable.

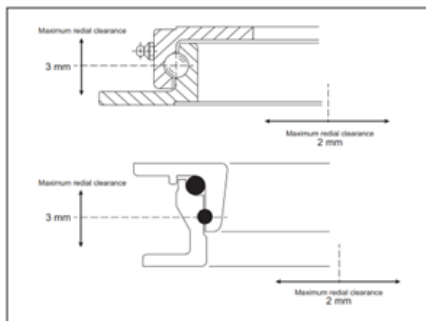

Control of bearing

### 8.10. Maintenance of Extendable Lowbed Platform

The telescopic frame should be checked once a week with at least a full extension. Telescopic parts should always be kept clean and oiled, and it should be ensured that there is no dust or dirt when closing the telescopic frame. Dust and dirt will settle in the chassis grooves and cause friction and damage to related parts. The male chassis should be lubricated every 15 days.

#### 8.10.1. Tightening Torques of Wheel Nuts



Check the tightening torque of the bolts after 50 and 200 km.

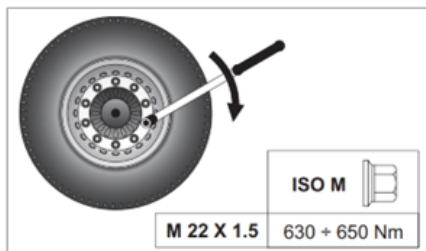

Tightening the bolts

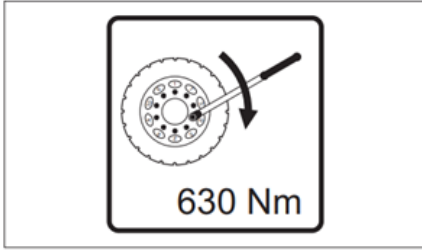

*Tightening the bolts*

### 8.10.2. Nut Tightening Sequence

After replacing a wheel or installing a new wheel, tighten the respective nuts in the THREE STAGES and sequence described below.

- 1)Tighten the nuts on the wheel so that the wheel is flat against the axle.
- 2)Tighten the wheel nuts to half the required tightening torque.
- 3)Then tighten all the nuts in the order shown from 1 to 10 until the required torque values (630 ÷ 650 Nm) are reached.

### 8.10.3. Tire Inflation Pressure

| Tires         |          |          |
|---------------|----------|----------|
| Tire Size     | Index    | Pressure |
| 245/70 R 17.5 | 143/141J | 8.5 Bar  |



**Lastik basıncı araç birkaç saat park halinde bekledikten sonra lastikler “soğukken” kontrol edilmelidir.**



**Bir lastiğin havasını asla sıcakken indirmeyiniz.**



**Takılı iki lastik arasındaki yetersiz basınç anormal lastik aşınmasına ve temas halindeki kısımların aşırı ısınmasına neden olur. Normal lastik aşınması için lastik hava değerleri düzenli olarak kontrol edilmeli ve basınç değerleri tüm lastiklerde eşit olmalıdır.**

### 8.10.4. Alloy Rim Wheels

The tightening torque specified by the valve manufacturer must be between the values below.

9 - 14 Nm (0.91 – 1,41 kgm)

Only in this way can the correct compression of the O-ring seal be achieved. Over-tightening the valve can deform the O-ring and damage the valve seat, causing air leakage.

### 8.11. Hidrolic Oils

#### Hydraulic Oil Operating Temperature:

The minimum operating temperature is -20°C and the maximum operating temperature is 80°C. The ideal operating temperature of the oil in the system is 35°C – 55°C.

- Mineral based hydraulic oil should be used in the system.
- The quality, cleanliness and operating fluidity of hydraulic oil are very important for its economy and service life.

- The viscosity of the hydraulic oil in the system should be between 12–100 cSt (mm<sup>2</sup>/s). Ideal viscosity is between 20–40 cSt.
- Low-viscosity hydraulic oils should be preferred in cold weather and high-viscosity hydraulic oils in hot weather.

| Oils           |                   |                  |                   |                  |                |
|----------------|-------------------|------------------|-------------------|------------------|----------------|
|                | Temperature Range | -57 C° to +25 C° | -25 C° to + 35 C° | -10 C° to +50 C° | >+50 C°        |
| Hydraulic Oils | Total             | EQUVIS XLT 15    | EQUVIS ZS 22      | EQUVIS ZS 32     | EQUVIS ZS 46   |
|                | ESSO / MOBIL      | UNIVIS HVI-13    | UNIVIS N 22       | UNIVIS N 32      | UNIVIS N 46    |
|                | SHELL             | -                | TELLUS S2 V 22    | TELLUS S2 V 32   | TELLUS S2 V 46 |
|                | BP                | ENERGOL SHF-LT15 | BARTAN HV 22      | BARTAN HV 32     | BARTAN HV 46   |
|                | ELF               | -                | HYDRELF DS 22     | HYDRELF DS 32    | HYDRELF DS 46  |
|                | UNIL              | -                | HVB 22            | HVB 32           | HVB 46         |
|                | Q8                | Q8 HINDEMITH 15  | HANDEL 22         | HANDEL 32        | HANDEL 46      |
|                | Grease            | MULTIS EP2       | BEACON EP2        | ALVANIA EP2      | MULTIFAK EP2   |

 **For trouble-free operation of the hydraulic system, an oil with a viscosity suitable for the climate / seasonal conditions in where the vehicle is used should be used.**

 **Failure to use hydraulic oil with a viscosity suitable for climate / seasonal conditions in the hydraulic system will cause temporary or permanent damages and functional working problems.**

 **In cases where the type of hydraulic oil used in the vehicle needs to be changed, the system must be cleaned carefully.**

### 8.11.1. Mixing Hydraulic Oils

Hydraulic oils cannot be mixed, or can be mixed with each other only conditionally. When oils of various manufacturers

or of various types are mixed, sludge and sludge formation can be encountered. These can cause malfunction and damage to the hydraulic system. Therefore, there is no guarantee for the use of mixed oils. The relevant mineral oil manufacturer should be consulted regarding the miscibility of hydraulic oils.

 **Before using other oil types, make sure that these oils have the same characteristics as the oils given in the Table. Otherwise, wash the system carefully.**

 **The use of incompatible oils will void all warranties on hydraulic system components.**

 **The use of incompatible oils can cause the steering and lift cylinders to be suddenly damaged and lose their function.**



**Kässbohrer Sales GmbH**

**Ulm** | Im Katzenwinkel 5, 88480 Achstetten, Deutschland | T +49 (0) 7392 96797-0 | F +49 (0) 7392 96797-67

**Goch** | Siemensstraße 74, 47574 Deutschland | T +49 (0) 2823 9721-0 | F +49 (0) 2823 9721-21 | E [info@kaessbohrer.com](mailto:info@kaessbohrer.com) | [www.kaessbohrer.com](http://www.kaessbohrer.com)  
[info@kaessbohrer.com](mailto:info@kaessbohrer.com) | [spareparts@kaessbohrer.com](mailto:spareparts@kaessbohrer.com) | [aftersales@kaessbohrer.com](mailto:aftersales@kaessbohrer.com)

**Kässbohrer**

*Ingenuity, since 1893*